

Mazda Cosmo

1977
Wiring Diagram

mazda

How to use this wiring diagram

In this booklet, whole electrical systems are divided into sub systems, such as charging system, ignition system ---, and the wiring diagram of each system is shown in one page respectively for your easy reference.

When you have the trouble in the charging system for instance,

- 1 OPEN THE PAGE OF "CHARGING SYSTEM" AND THE LAST FOLDED PAGE "FOR COMMON CONNECTORS".
- 2 FIND OUT THE CONNECTORS WHICH YOU WANT TO CHECK ON THE DIAGRAM.

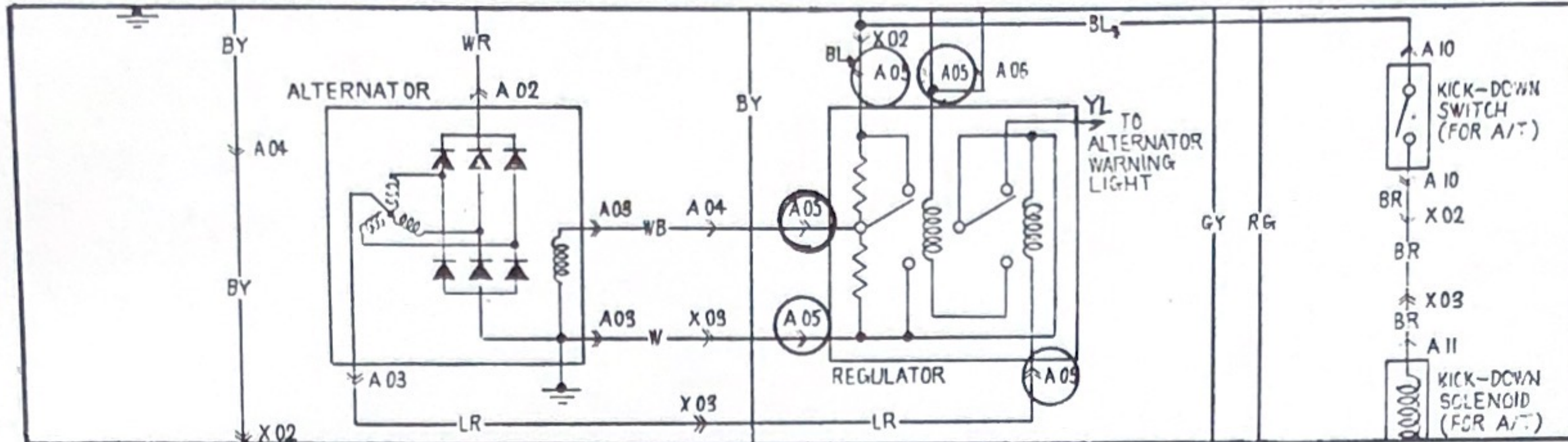

- 3 THEN LOOK UP THE NUMBER IN THE CONNECTOR LIST, THE NUMBERS WHICH START WITH "X" ARE LISTED IN THE LAST PAGE. REST OF THEM ARE AT THE BOTTOM OF EACH PAGE "A" "B" "C" -----,

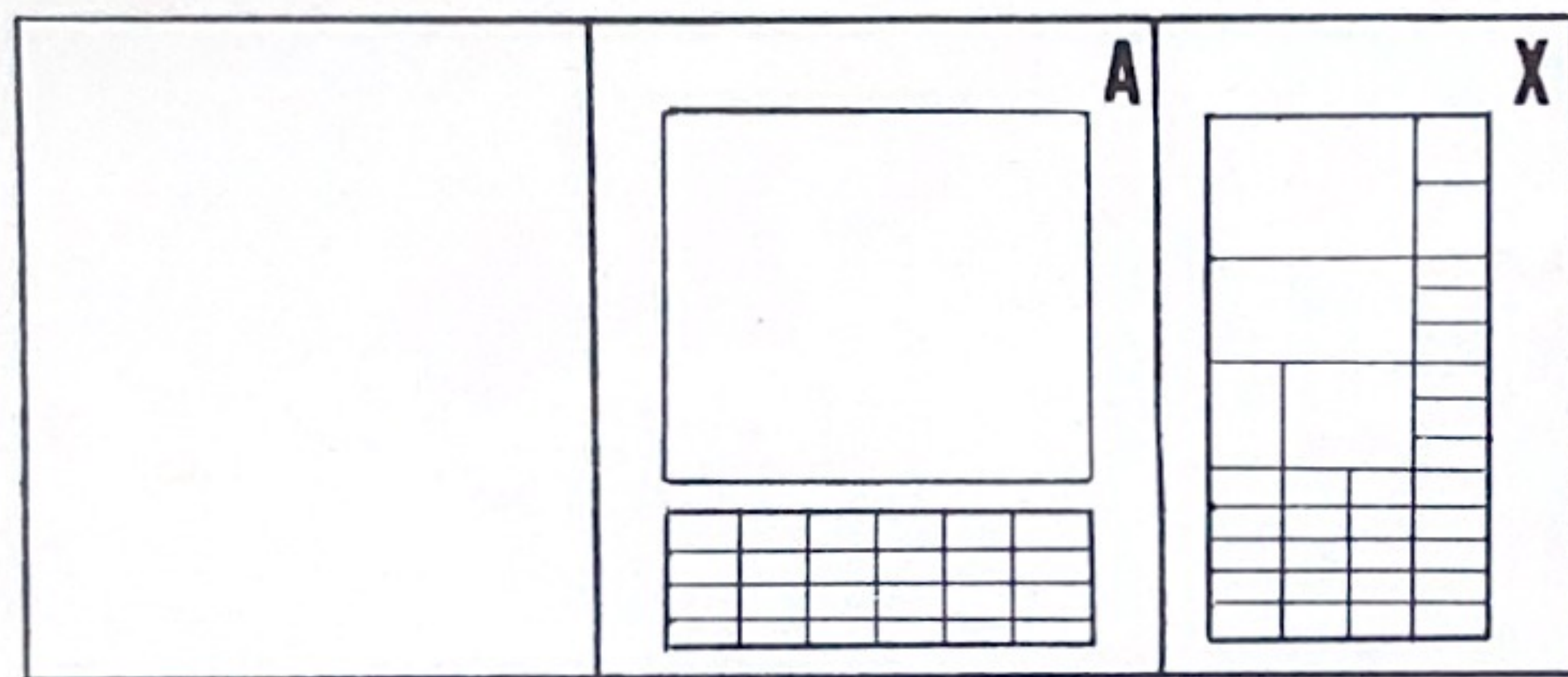

4 THE CONNECTOR LISTS SHOW

- SHAPE OF CONNECTOR
- LOCATION OF CONNECTOR
- COLORS OF WIRES

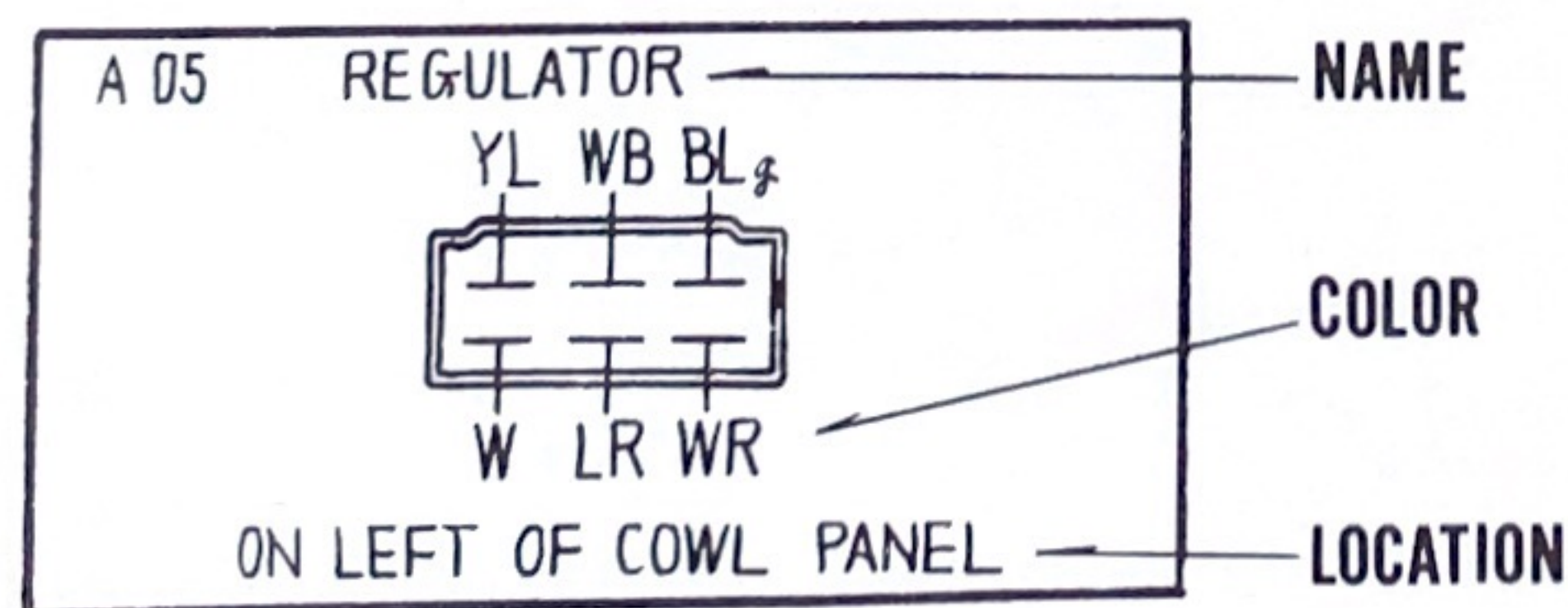

—WIRING CODE—

CODE	COLOR
B	BLACK
Br	BROWN
G	GREEN
Gy	GRAY
L	BLUE
Lg	LIGHT GREEN
O	ORANGE
R	RED
W	WHITE
Y	YELLOW

—EXAMPLE—

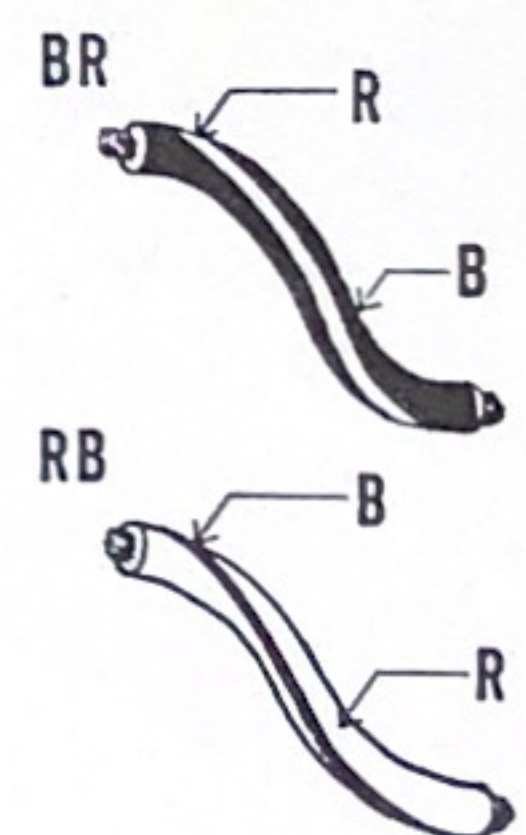

—CONNECTOR TYPE—



This booklet has two INDEXES, i.e.,

- INDEX OF COMPONENT PARTS IN ALPHABETICAL ORDER
- INDEX OF COMPONENT PARTS BY RESPECTIVE SUB-SYSTEMS

You can locate the component parts on the car by this index.

Symbol in the wiring diagram.

BATTERY	GROUND	FUSE FUSIBLE LINK	SWITCH	MOTOR	COIL	RESISTOR	VARIABLE RESISTOR	DIODE	BULB	HORN	SPEAKER	PUMP	RELAY

INDEX

COMPONENT	PAGE	COMPONENT	PAGE	COMPONENT	PAGE
AIR VENT VALVE	B	IDLE SWITCH	B	VACUUM CONTROL VALVE (for CALIFORNIA) .	B
ALTERNATOR	A	IDLING AMPLIFIER STABILIZER	G	WATER TEMPERATURE GAUGE	C
ALTERNATOR WARNING LIGHT	C	IGNITION COIL	B	WATER TEMPERATURE GAUGE UNIT	C
ANTI-AFTERBURN VALVE	B	IGNITION KEY REMINDER SWITCH	H	WATER TEMPERATURE SWITCH	B
AUTO CLOCK	H	IGNITION RELAY	B		
		IGNITION SWITCH	A~J		
BACK-UP LIGHT	F	ILLUMINATION LIGHT			
BACK-UP LIGHT SWITCH	F	ASH TRAY	E		
BATTERY	A~J	CIGAR LIGHTER	E		
BRAKE FAILURE SWITCH	C	HEATER	E		
BRAKE FLUID LEVEL SENSOR	C	METER	E		
BRAKE WARNING LIGHT	C	RADIO	E		
BRAKE WARNING LIGHT CHECKER	C	STEREO	E		
BUZZER	H	INHIBITOR SWITCH (for A/T)	A,F,		
		INTERMITTENT RELAY	D		
CARBURETOR HEATER	B	KICK DOWN SOLENOID (for A/T)	B		
CENTRAL CONTROL UNIT		KICK DOWN SWITCH (for A/T)	B		
FLASHER UNIT	F	KICK DOWN RELAY (for A/T)	B		
HORN RELAY	F				
SCREEN WIPER RELAY	D	LICENSE LIGHT	F		
CHOKE MAGNET	B	LUGGAGE COMPARTMENT LIGHT	H		
CHOKE RELAY	B	LUGGAGE COMPARTMENT LIGHT SWITCH	H		
CIGAR LIGHTER	H				
COASTING VALVE	B	MAGNET CLUTCH	G		
COMBINATION SWITCH		MAIN FUSE	A J		
DIMMER SWITCH	E	MARKER LIGHT	F		
HAZARD SWITCH	F	MILEAGE SENSOR (for A/T)	B		
LIGHT SWITCH ASS'Y	A,E,F,				
PASSING HIGH BEAM SWITCH	E	NO.1 CHOKE SWITCH (for CALIFORNIA)	B		
SCREEN WASHER SWITCH	D	NO.2 CHOKE SWITCH	B		
SCREEN WIPER SWITCH	D	NO.1 RELIEF VALVE SOLENOID	B		
TURN SIGNAL SWITCH	F	NO.2 RELIEF VALVE SOLENOID	B		
COOLANT LEVEL SENSOR	C	NO.1 VACUUM SWITCH	B		
COOLANT LEVEL WARNING LIGHT	C	NO.2 VACUUM SWITCH	B		
COOLER RELAY	B				
COOLER SWITCH	G	OIL LEVEL SENSOR	C		
COURTESY LIGHT	H	OIL LEVEL WARNING LIGHT	C		
		OVER DRIVE SWITCH (for CALIFORNIA M/T) .	B		
DIODE					
DOOR SWITCH	H	PANEL LIGHT RESISTOR	A,E,		
HEATED WINDOW SWITCH	G	PARKING BRAKE SWITCH	C		
STARTER MOTOR	A	POWER VALVE SOLENOID	B		
DISTRIBUTOR	B	POWER WINDOW	J		
DISTRIBUTOR RELAY	B	POWER WINDOW SWITCH	J		
(for CALIFORNIA)					
DOOR MIRROR	I	RADIO	G		
DOOR MIRROR CONTROL	I	REGULATOR	A		
		RETARD RELAY (for CALIFORNIA)	B		
EGR RELAY (for A/T)	B	RICHER SOLENOID (for M/T)	B		
EGR VALVE (for A/T)	B	ROOM LIGHT	H		
EGR WARNING LIGHT (for A/T)	B				
EMISSION CONTROL UNIT	B	SCREEN WASHER MOTOR	D		
EXTERNAL RESISTOR	B	SCREEN WIPER MOTOR	D		
		SEAT BELT WARNING LIGHT	H		
FUEL GAUGE	C	SEAT BELT SWITCH	H		
FUEL GAUGE TANK UNIT	C	SELECT INDICATOR LIGHT	A		
FUEL PUMP	B	SHORT RELAY	B		
FUSE HOLDER		SIDE MARKER LIGHT	F		
HEATER, STEREO, RADIO	G	SPEAKER	G		
SCREEN WIPER	D	STARTER MOTOR	A		
POWER WINDOW	J	STEREO	G		
		STOP LIGHT CHECKER	F		
GLOVE BOX LIGHT	H	STOP LIGHT SWITCH	F		
		STOP & TAIL LIGHT	F		
HEADLIGHT	E	SUB-ZERO MOTOR	A		
HEATED WINDOW	G	SUB-ZERO SENSOR	A		
HEATED WINDOW RELAY	G				
HEATED WINDOW SWITCH	G	TACHOMETER	C		
HEATER BLOWER MOTOR	G	THERMISTOR	G		
HEATER BLOWER MOTOR SWITCH	G	THERMO CONTROL RESISTOR	G		
HEATER BLOWER MOTOR RESISTOR	G	THROTTLE OPENER SOLENOID	B		
HEAT HAZARD SENSOR	B	TIMER	H		
HEAT INDICATOR LIGHT	B	TURN SIGNAL LIGHT	F		
HIGH BEAM INDICATOR LIGHT	H	TURN SIGNAL INDICATOR LIGHT	F		
HORN	F				
HORN SWITCH	F				

PAGE	SUB SYSTEM
A -----	• CHARGING SYSTEM • STARTING SYSTEM
B -----	• EMISSION CONTROL SYSTEM • IGNITION SYSTEM • FUEL PUMP • KICK DOWN SYSTEM
C -----	• METER SYSTEM • WARNING LIGHT SYSTEM
D -----	• SCREEN WIPER & WASHER SYSTEM
E -----	• HEADLIGHT SYSTEM
F -----	• TURN SIGNAL, HAZARD & STOP LIGHT SYSTEM • HORN • MARKER LIGHT
G -----	• HEATER SYSTEM • AIR CONDITIONER SYSTEM • RADIO • STEREO
H -----	• SEAT BELT WARNING SYSTEM • COURTESY LIGHT • LUGGAGE COMPARTMENT LIGHT • GLOVE BOX LIGHT • CIGAR LIGHTER • AUTO CLOCK
I -----	• REMOTE CONTROL DOOR MIRROR
J -----	• POWER WINDOW

INDEX

PAGE	TITLE	PAGE
1	INTRODUCTION	1
2	1. FIND OUT THE NAME OF THE...	2
3	2. FIND OUT THE NAME OF THE...	3
4	3. FIND OUT THE NAME OF THE...	4
5	4. FIND OUT THE NAME OF THE...	5
6	5. FIND OUT THE NAME OF THE...	6
7	6. FIND OUT THE NAME OF THE...	7
8	7. FIND OUT THE NAME OF THE...	8
9	8. FIND OUT THE NAME OF THE...	9
10	9. FIND OUT THE NAME OF THE...	10
11	10. FIND OUT THE NAME OF THE...	11
12	11. FIND OUT THE NAME OF THE...	12
13	12. FIND OUT THE NAME OF THE...	13
14	13. FIND OUT THE NAME OF THE...	14
15	14. FIND OUT THE NAME OF THE...	15
16	15. FIND OUT THE NAME OF THE...	16
17	16. FIND OUT THE NAME OF THE...	17
18	17. FIND OUT THE NAME OF THE...	18
19	18. FIND OUT THE NAME OF THE...	19
20	19. FIND OUT THE NAME OF THE...	20
21	20. FIND OUT THE NAME OF THE...	21
22	21. FIND OUT THE NAME OF THE...	22
23	22. FIND OUT THE NAME OF THE...	23
24	23. FIND OUT THE NAME OF THE...	24
25	24. FIND OUT THE NAME OF THE...	25
26	25. FIND OUT THE NAME OF THE...	26
27	26. FIND OUT THE NAME OF THE...	27
28	27. FIND OUT THE NAME OF THE...	28
29	28. FIND OUT THE NAME OF THE...	29
30	29. FIND OUT THE NAME OF THE...	30
31	30. FIND OUT THE NAME OF THE...	31
32	31. FIND OUT THE NAME OF THE...	32
33	32. FIND OUT THE NAME OF THE...	33
34	33. FIND OUT THE NAME OF THE...	34
35	34. FIND OUT THE NAME OF THE...	35
36	35. FIND OUT THE NAME OF THE...	36
37	36. FIND OUT THE NAME OF THE...	37
38	37. FIND OUT THE NAME OF THE...	38
39	38. FIND OUT THE NAME OF THE...	39
40	39. FIND OUT THE NAME OF THE...	40
41	40. FIND OUT THE NAME OF THE...	41
42	41. FIND OUT THE NAME OF THE...	42
43	42. FIND OUT THE NAME OF THE...	43
44	43. FIND OUT THE NAME OF THE...	44
45	44. FIND OUT THE NAME OF THE...	45
46	45. FIND OUT THE NAME OF THE...	46
47	46. FIND OUT THE NAME OF THE...	47
48	47. FIND OUT THE NAME OF THE...	48
49	48. FIND OUT THE NAME OF THE...	49
50	49. FIND OUT THE NAME OF THE...	50
51	50. FIND OUT THE NAME OF THE...	51
52	51. FIND OUT THE NAME OF THE...	52
53	52. FIND OUT THE NAME OF THE...	53
54	53. FIND OUT THE NAME OF THE...	54
55	54. FIND OUT THE NAME OF THE...	55
56	55. FIND OUT THE NAME OF THE...	56
57	56. FIND OUT THE NAME OF THE...	57
58	57. FIND OUT THE NAME OF THE...	58
59	58. FIND OUT THE NAME OF THE...	59
60	59. FIND OUT THE NAME OF THE...	60
61	60. FIND OUT THE NAME OF THE...	61
62	61. FIND OUT THE NAME OF THE...	62
63	62. FIND OUT THE NAME OF THE...	63
64	63. FIND OUT THE NAME OF THE...	64
65	64. FIND OUT THE NAME OF THE...	65
66	65. FIND OUT THE NAME OF THE...	66
67	66. FIND OUT THE NAME OF THE...	67
68	67. FIND OUT THE NAME OF THE...	68
69	68. FIND OUT THE NAME OF THE...	69
70	69. FIND OUT THE NAME OF THE...	70
71	70. FIND OUT THE NAME OF THE...	71
72	71. FIND OUT THE NAME OF THE...	72
73	72. FIND OUT THE NAME OF THE...	73
74	73. FIND OUT THE NAME OF THE...	74
75	74. FIND OUT THE NAME OF THE...	75
76	75. FIND OUT THE NAME OF THE...	76
77	76. FIND OUT THE NAME OF THE...	77
78	77. FIND OUT THE NAME OF THE...	78
79	78. FIND OUT THE NAME OF THE...	79
80	79. FIND OUT THE NAME OF THE...	80
81	80. FIND OUT THE NAME OF THE...	81
82	81. FIND OUT THE NAME OF THE...	82
83	82. FIND OUT THE NAME OF THE...	83
84	83. FIND OUT THE NAME OF THE...	84
85	84. FIND OUT THE NAME OF THE...	85
86	85. FIND OUT THE NAME OF THE...	86
87	86. FIND OUT THE NAME OF THE...	87
88	87. FIND OUT THE NAME OF THE...	88
89	88. FIND OUT THE NAME OF THE...	89
90	89. FIND OUT THE NAME OF THE...	90
91	90. FIND OUT THE NAME OF THE...	91
92	91. FIND OUT THE NAME OF THE...	92
93	92. FIND OUT THE NAME OF THE...	93
94	93. FIND OUT THE NAME OF THE...	94
95	94. FIND OUT THE NAME OF THE...	95
96	95. FIND OUT THE NAME OF THE...	96
97	96. FIND OUT THE NAME OF THE...	97
98	97. FIND OUT THE NAME OF THE...	98
99	98. FIND OUT THE NAME OF THE...	99
100	99. FIND OUT THE NAME OF THE...	100

• CHARGING SYSTEM • STARTING SYSTEM

A

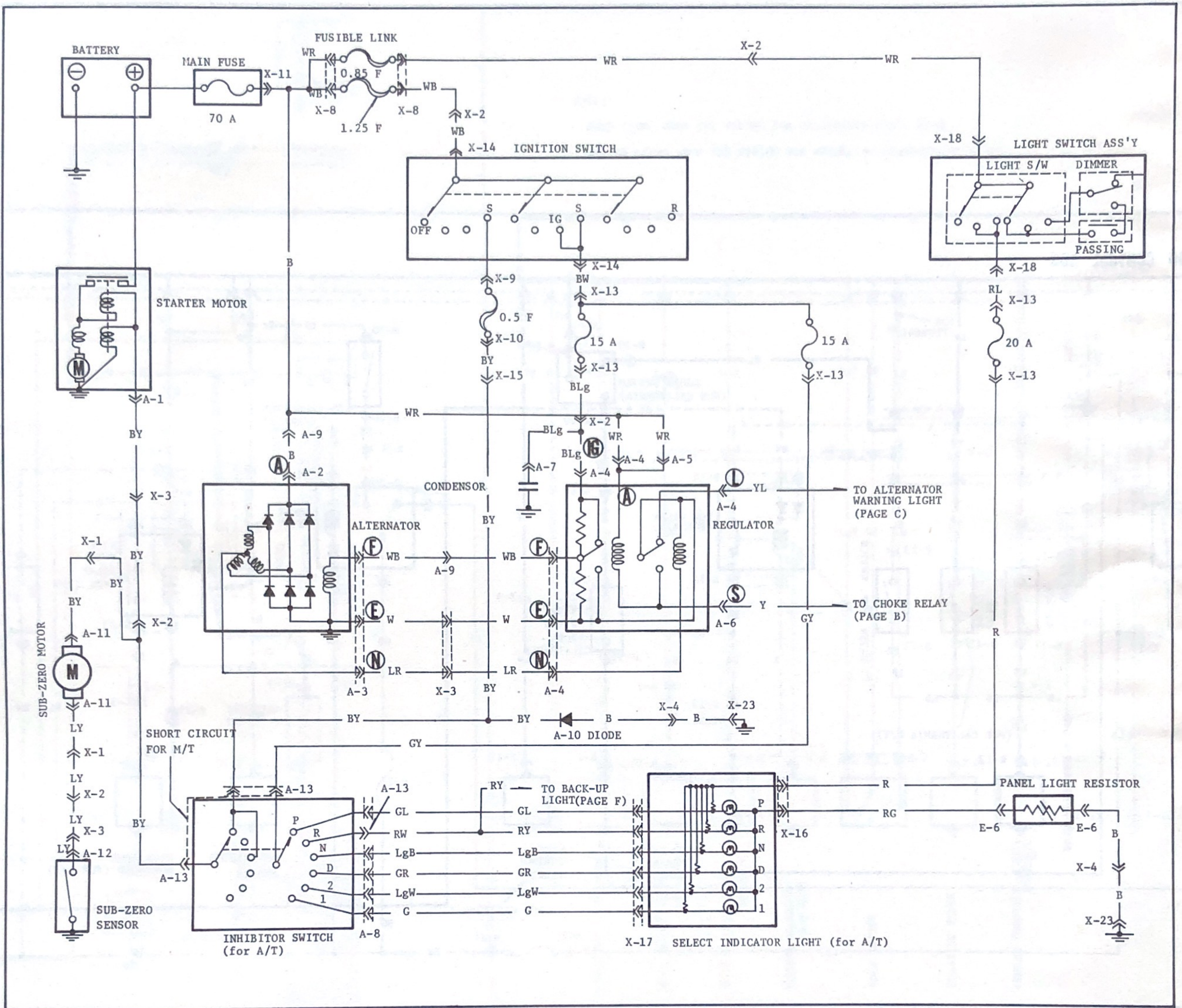

<p>A-1 STARTER MOTOR</p> <p>BY</p> <p>AT STARTER MOTOR</p>	<p>A-2 ALTERNATOR</p> <p>B</p> <p>AT ALTERNATOR</p>	<p>A-3 ALTERNATOR</p> <p>W WB</p> <p>LR</p> <p>AT ALTERNATOR</p>	<p>A-4 REGULATOR</p> <p>YL WB BLg</p> <p>W LR WR</p> <p>AT REGULATOR CONNECTOR</p>
<p>A-5 REGULATOR</p> <p>WR</p> <p>AT REGULATOR CONNECTOR</p>	<p>A-6 REGULATOR</p> <p>Y</p> <p>AT REGULATOR CONNECTOR</p>	<p>A-7 CONDENSOR</p> <p>BLg</p> <p>AT CONDENSOR - NEAR REGULATOR</p>	<p>A-8 INHIBITOR SWITCH (FOR A/T)</p> <p>G GR GL</p> <p>LgW LgB</p> <p>BOTTOM OF SELECT LEVER</p>
<p>A-9 CONNECTOR TO ALTERNATOR</p> <p>WB B</p> <p>ON LEFT WHEEL APRON</p>	<p>A-10 DIODE</p> <p>BY B</p> <p>UNDER DASHBOARD LEFT</p>	<p>A-11 SUB ZERO MOTOR</p> <p>BY LY</p> <p>ON RIGHT FRONT FENDER APRON</p>	<p>A-12 SUB ZERO SENSOR</p> <p>LY</p> <p>AT SUB ZERO SENSOR</p>
<p>A-13 INHIBITOR SWITCH (FOR A/T)</p> <p>BY GY</p> <p>BY RW</p> <p>BOTTOM OF SELECT LEVER</p>	<p>E-6 PANEL LIGHT RESISTOR</p> <p>RG B</p> <p>AT PANEL LIGHT RESISTOR CONNECTOR</p>		

• EMISSION CONTROL SYSTEM

• KICK-DOWN SYSTEM

• IGNITION SYSTEM

• FUEL PUMP

NOTE: BOLD LINES SHOW THE WIRING FOR CALIFORNIA SPEC. MODEL. DOTTED LINES SHOW THE WIRING FOR AUTOMATIC TRANSMISSION MODEL.


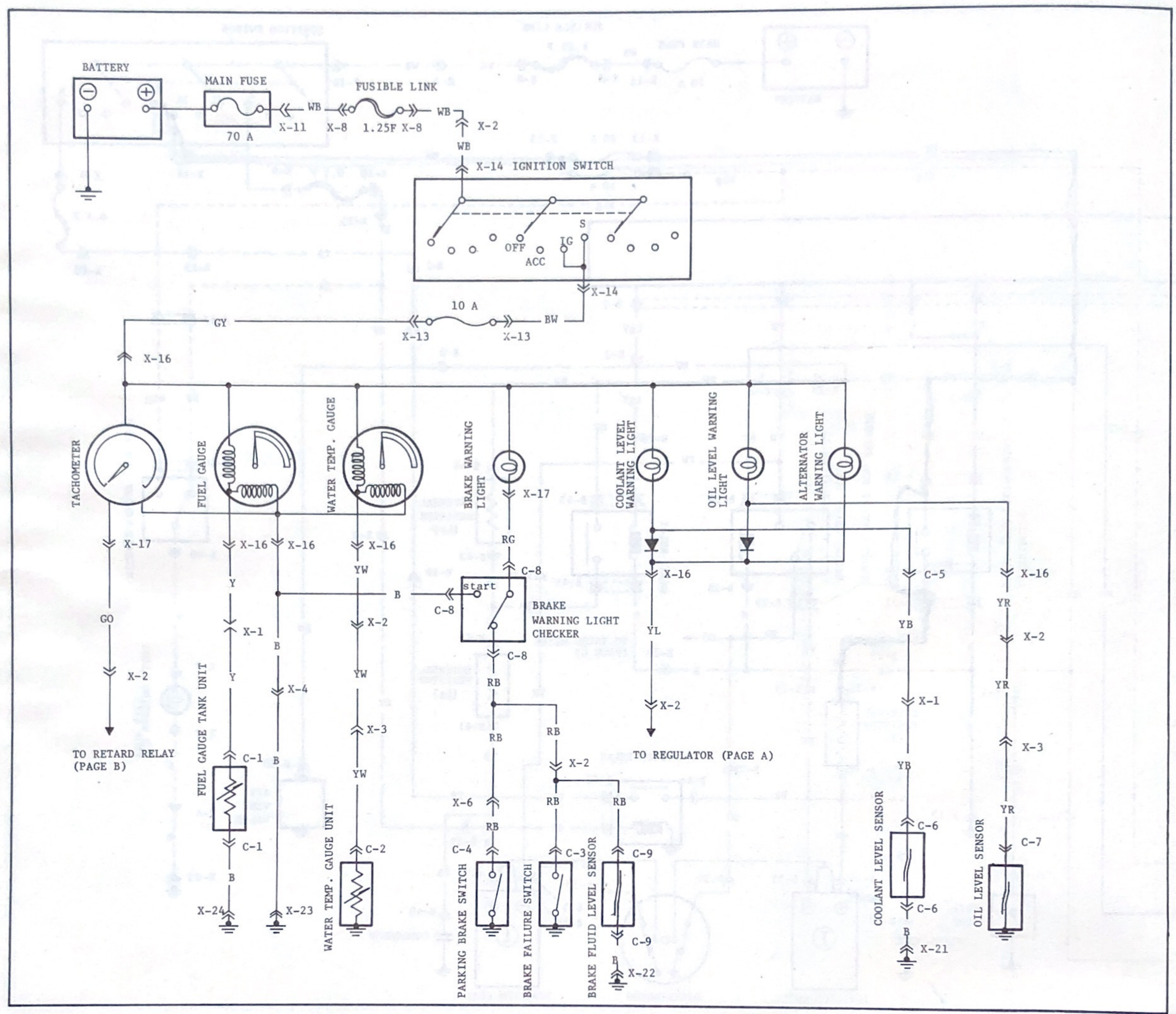

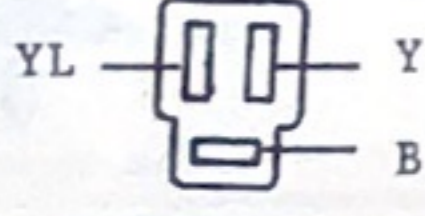

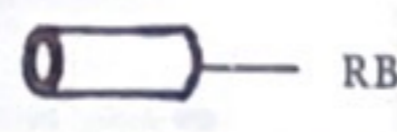
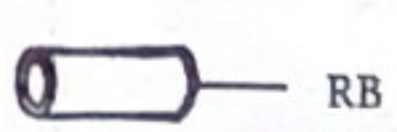

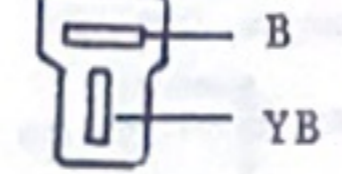

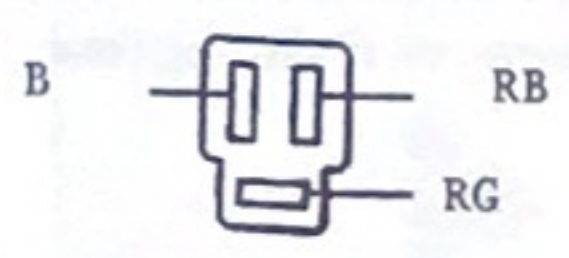

Table of component locations for terminals B-1 through B-51. Each entry includes a terminal number, component name, and location (e.g., 'B-1 POWER VALVE SOLENOID NEAR RIGHT SIDE OF CARBURETOR').

Table of component locations for terminals B-32 through B-51. Each entry includes a terminal number, component name, and location (e.g., 'B-32 FUEL PUMP IN LOGGAGE COMPARTMENT').

C

• METER SYSTEM • WARNING LIGHT SYSTEM





<p>C-1 FUEL GAUGE TANK UNIT</p>  <p>AT FUEL GAUGE TANK UNIT</p>	<p>C-2 WATER TEMP. GAUGE UNIT</p>  <p>AT WATER TEMP. GAUGE UNIT - ON REAR HOUSING</p>	<p>C-3 BRAKE FAILURE SWITCH</p>  <p>AT BRAKE FAILURE SWITCH</p>	<p>C-4 PARKING BRAKE SWITCH</p>  <p>NEAR PARKING BRAKE LEVER</p>
<p>C-5 COOLANT LEVEL WARNING LIGHT</p>  <p>BEHIND METER SET</p>	<p>C-6 COOLANT LEVEL SENSOR</p>  <p>NEAR RADIATOR SUB TANK</p>	<p>C-7 OIL LEVEL SENSOR</p>  <p>NEAR LEFT SIDE OF ENGINE</p>	<p>C-8 BRAKE WARNING LIGHT CHECKER</p>  <p>AT STEERING COLUMN SUPPORT</p>
<p>C-9 BRAKE FLUID LEVEL SENSOR</p>  <p>NEAR BRAKE FLUID TANK</p>			

• SCREEN WIPER & WASHER SYSTEM

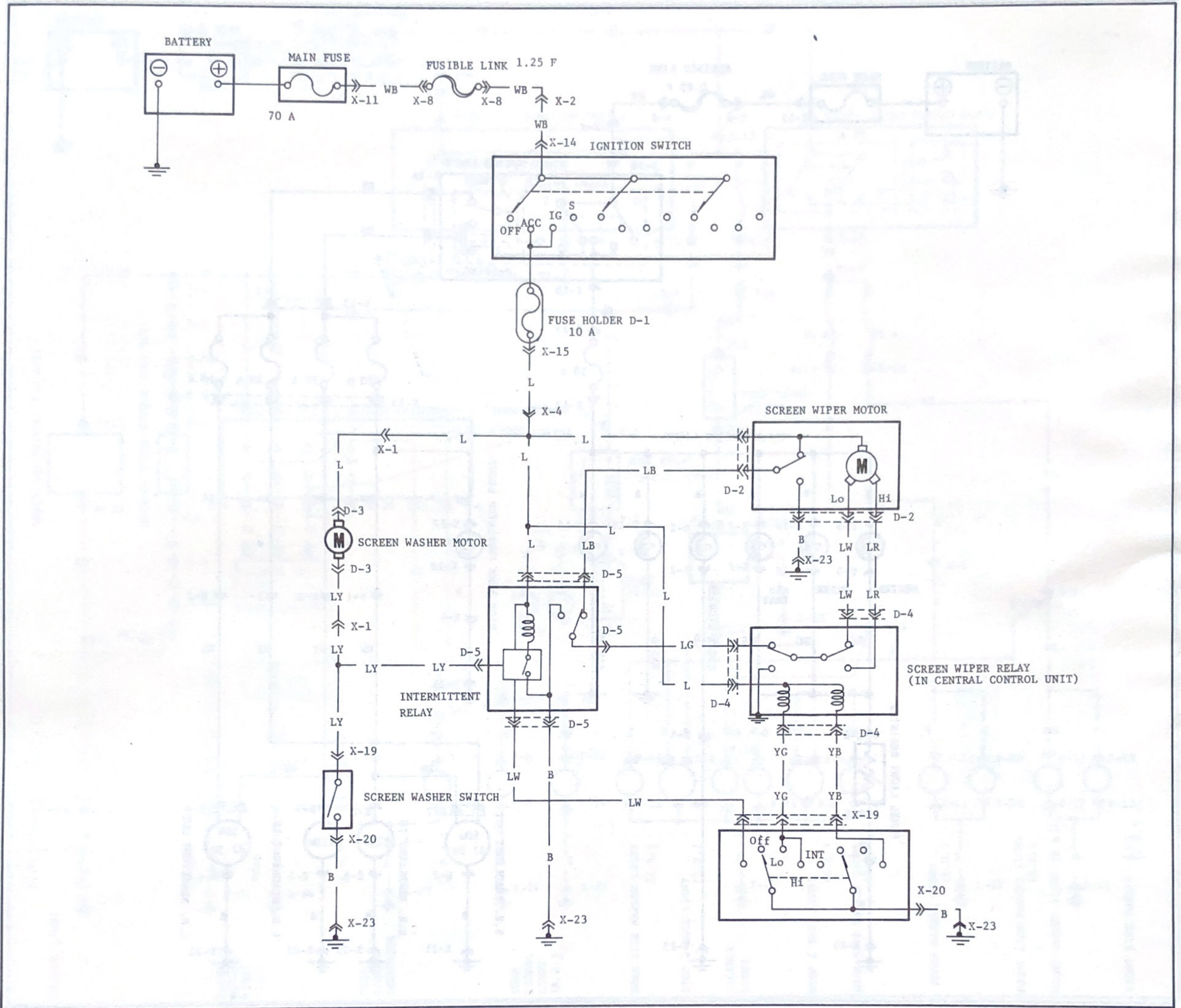
D

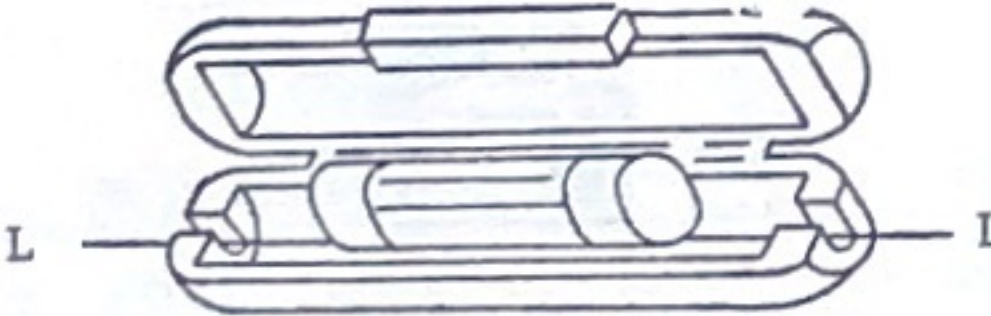
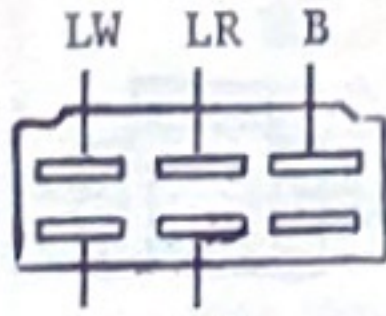

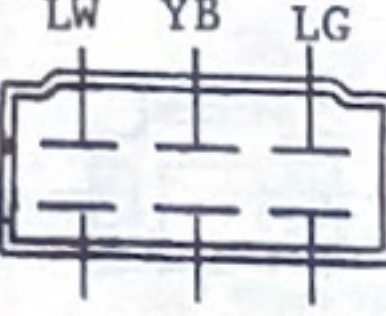
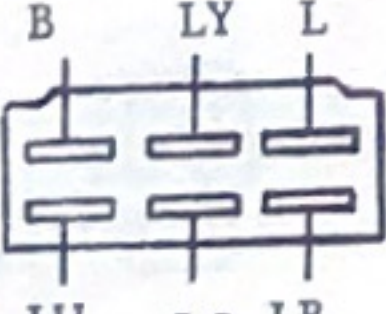
<p>D-1 FUSE HOLDER (10 A)</p>  <p>BEHIND IGNITION SWITCH</p>	<p>D-2 SCREEN WIPER MOTOR</p>  <p>AT SCREEN WIPER MOTOR CONNECTOR</p>	<p>D-3 SCREEN WASHER MOTOR</p>  <p>AT SCREEN WASHER MOTOR - ON RIGHT FRONT WHEEL APRON</p>	<p>D-4 SCREEN WIPER RELAY</p>  <p>AT C.C. UNIT</p>
<p>D-5 INTERMITTENT RELAY</p>  <p>UNDER DASHBOARD RIGHT</p>			

E

• HEADLIGHT & ILLUMINATION LIGHT SYSTEM

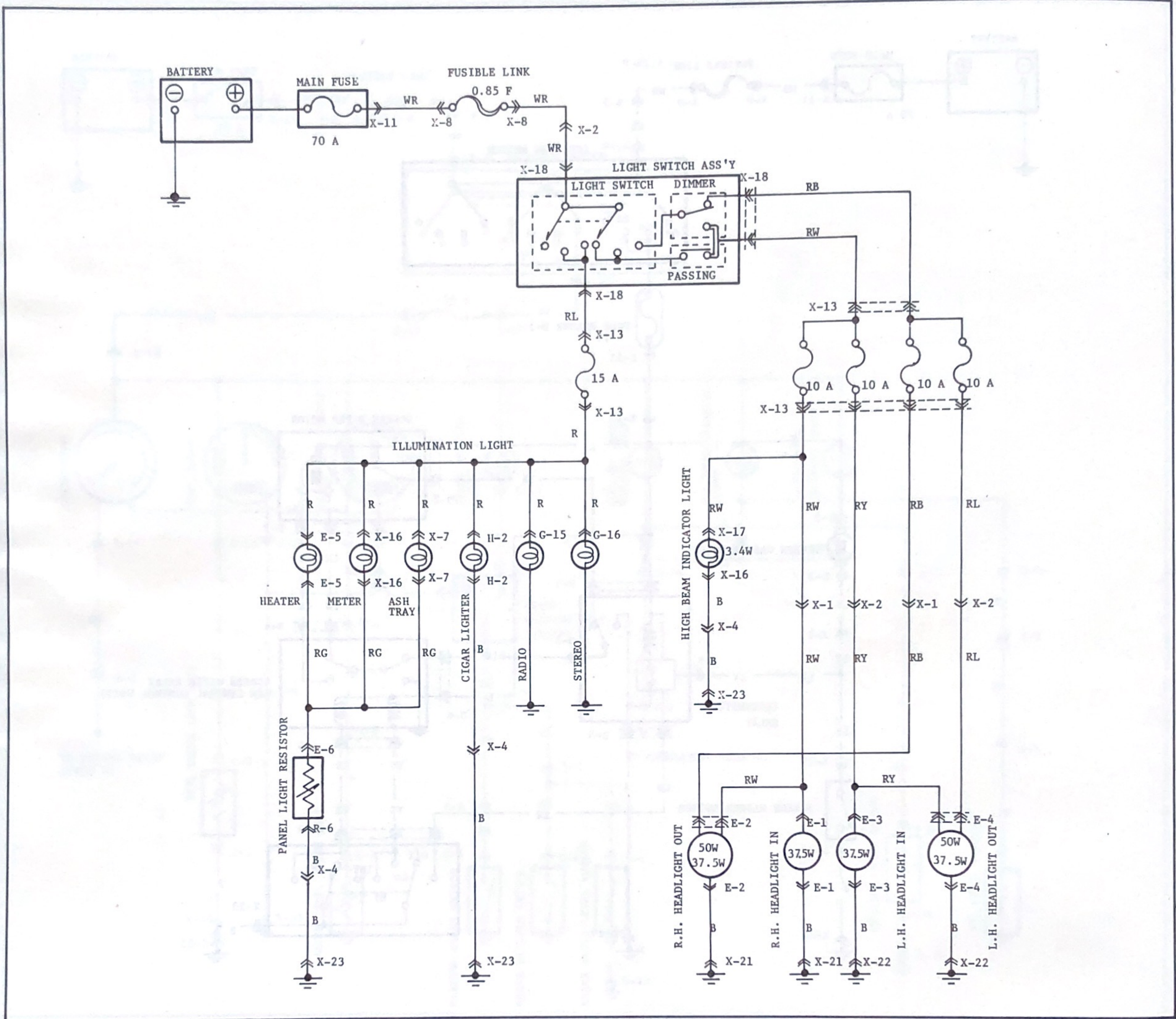

<p>E-1 HEADLIGHT IN (R.H.)</p> <p>AT HEADLIGHT IN</p>	<p>E-2 HEADLIGHT OUT (R.H.)</p> <p>AT HEADLIGHT OUT</p>	<p>E-3 HEADLIGHT IN (L.H.)</p> <p>AT HEADLIGHT IN</p>	<p>E-4 HEADLIGHT OUT (L.H.)</p> <p>AT HEADLIGHT OUT</p>
<p>E-5 HEATER ILLUMINATION LIGHT</p> <p>LEFT SIDE OF HEATER UNIT</p>	<p>E-6 PANEL LIGHT RESISTOR</p> <p>AROUND STEERING COLUMN SUPPORT</p>	<p>G-15 STEREO</p> <p>LEFT SIDE OF HEATER UNIT</p>	<p>G-16 RADIO</p> <p>AT RADIO</p>
<p>H-2 CIGAR LIGHTER</p> <p>AT CIGAR LIGHTER</p>			

• TURN SIGNAL, HAZARD & STOPLIGHT SYSTEM • HORN
• MARKER LIGHT

F

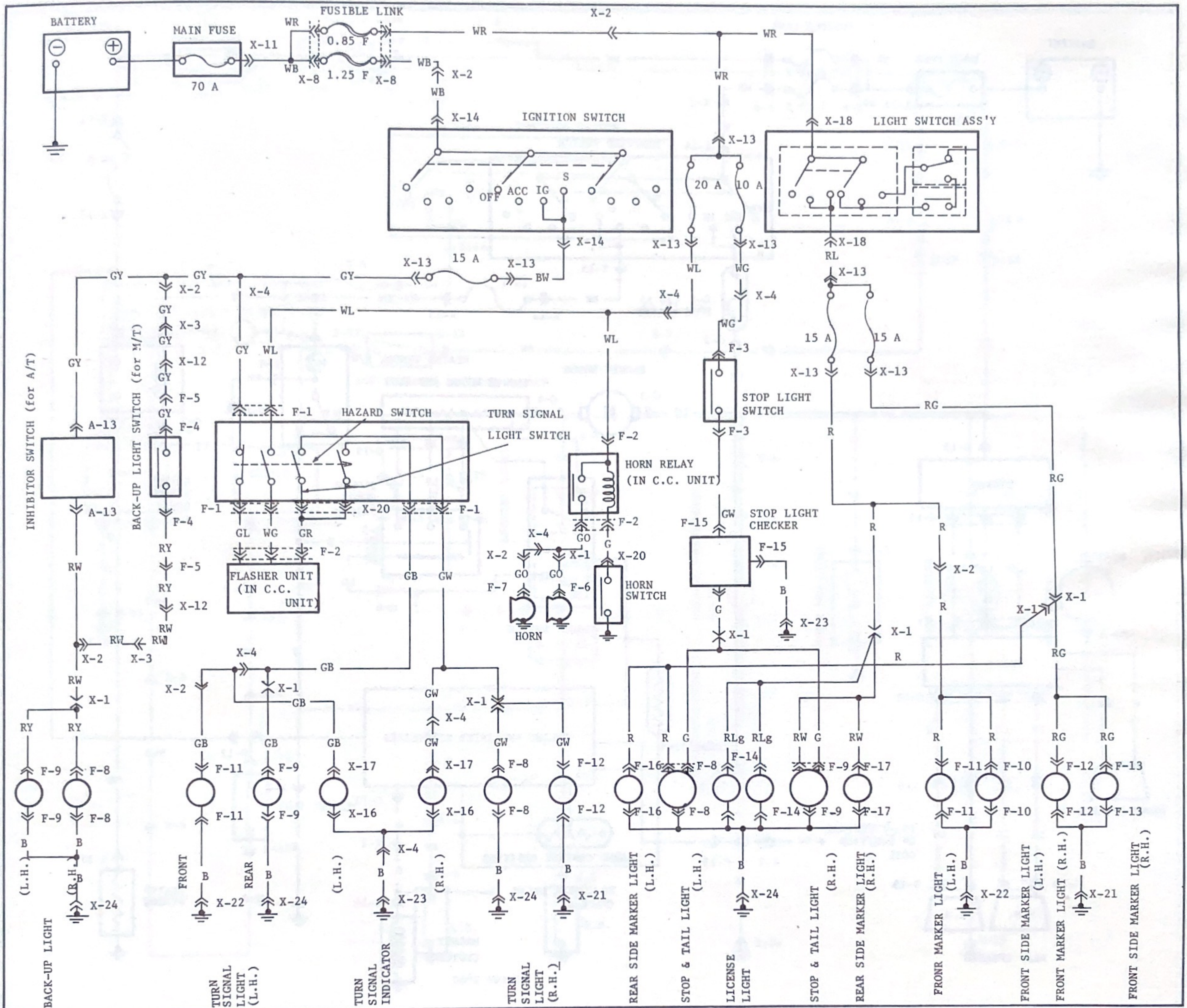

<p>F-1 COMBINATION SWITCH</p> <p>UNDER STEERING COLUMN SHAFT</p>	<p>F-2 CENTRAL CONTROL UNIT</p> <p>UNDER DASHBOARD LEFT</p>	<p>F-3 STOP LIGHT SWITCH</p> <p>ABOVE STOP PEDAL</p>	<p>F-4 BACK-UP LIGHT SWITCH</p> <p>AT BACK-UP LIGHT SWITCH - ON TRANSMISSION</p>	<p>F-5 CONNECTOR TO BACK-UP LIGHT SWITCH</p> <p>ON TOP OF ENGINE LEFT REAR</p>	<p>F-6 HORN</p> <p>AT HORN</p>
<p>F-7 HORN</p> <p>AT HORN</p>	<p>F-8 REAR COMBINATION LIGHT (R.H.)</p> <p>AT REAR COMBINATION LIGHT</p>	<p>F-9 REAR COMBINATION LIGHT (L.H.)</p> <p>AT REAR COMBINATION LIGHT</p>	<p>F-10 SIDE TURN SIGNAL LIGHT (R.H.)</p> <p>NEAR BEHIND L.H. HEADLIGHT</p>	<p>F-11 FRONT TURN SIGNAL & MARKER LIGHT (L.H.)</p> <p>NEAR BEHIND L.H. HEADLIGHT</p>	<p>F-12 FRONT TURN SIGNAL & MARKER LIGHT</p> <p>NEAR BEHIND R.H. HEADLIGHT</p>
<p>F-13 FRONT SIDE TURN MARKER LIGHT (R.H.)</p> <p>NEAR BEHIND R.H. HEADLIGHT</p>	<p>F-14 LICENSE LIGHT</p> <p>BEHIND REAR END PANEL CENTER</p>	<p>F-15 STOP LIGHT CHECKER</p> <p>AROUND STEERING COLUMN SHAFT UNDER</p>	<p>F-16 REAR SIDE MARKER LIGHT (R.H.)</p> <p>BEHIND REAR SIDE MARKER LIGHT</p>	<p>F-17 REAR SIDE MARKER LIGHT</p> <p>BEHIND REAR SIDE MARKER LIGHT</p>	

G

• HEATER SYSTEM • AIR CONDITIONER SYSTEM

• RADIO • STEREO

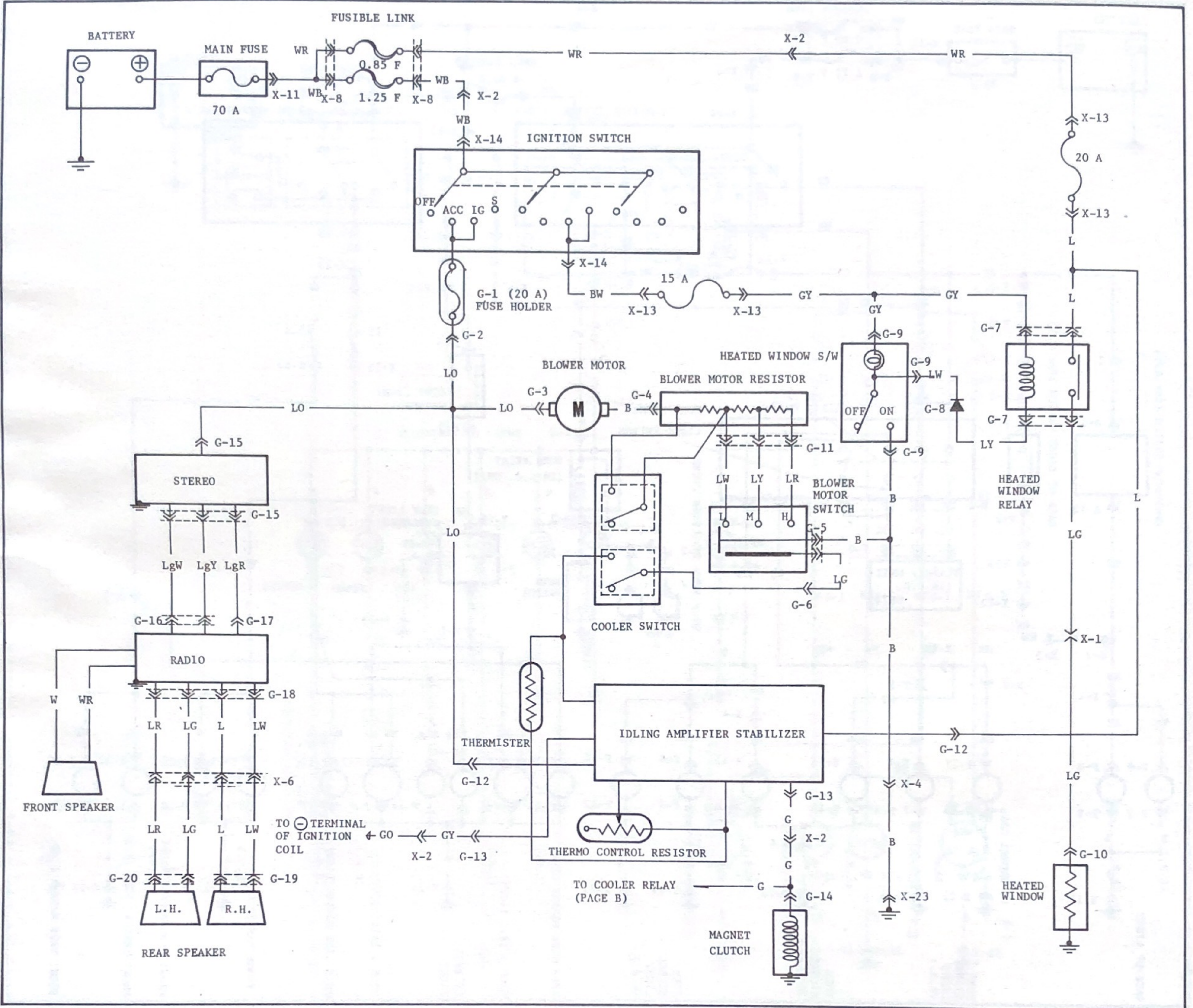

G-1 FUSIBLE LINK (20 A) BEHIND IGNITION SWITCH	G-2 CONNECTOR TO FUSIBLE LINK BEHIND IGNITION SWITCH	G-3 HEATER BLOWER MOTOR BEHIND GLOVE COMPARTMENT	G-4 HEATER BLOWER MOTOR BEHIND GLOVE COMPARTMENT	G-5 HEATER BLOWER MOTOR SWITCH LEFT SIDE OF HEATER UNIT	G-6 CONNECTOR TO COOLER SWITCH LEFT SIDE OF HEATER UNIT
G-7 HEATED WINDOW RELAY UNDER DASHBOARD LEFT	G-8 DIODE LEFT SIDE OF HEATER UNIT	G-9 HEATED WINDOW SWITCH LEFT SIDE OF HEATER UNIT	G-10 HEATED WINDOW IN LUGGAGE COMPARTMENT RIGHT	G-11 HEATER BLOWER MOTOR RESISTOR NEAR HEATER BLOWER MOTOR	G-12 CONNECTOR TO IDLING AMPLIFIER STABILIZER LEFT SIDE OF HEATER UNIT
G-13 CONNECTOR TO IDLING AMPLIFIER STABILIZER ABOVE CLUTCH PEDAL	G-14 MAGNET CLUTCH AT MAGNET CLUTCH CONNECTOR	G-15 STEREO AT STEREO	G-16 RADIO AT RADIO	G-17 RADIO AT RADIO	G-18 RADIO AT RADIO LG L
G-19 REAR SPEAKER (L.H.) ABOVE FUEL TANK LEFT - IN LUGGAGE COMPARTMENT	G-20 REAR SPEAKER (R.H.) ABOVE FUEL TANK RIGHT - IN LUGGAGE COMPARTMENT				

- SEAT BELT WARNING SYSTEM
- GLOVE BOX LIGHT

- COURTESY LIGHT
- CIGAR LIGHTER

- LUGGAGE COMPARTMENT LIGHT
- AUTO CLOCK

H

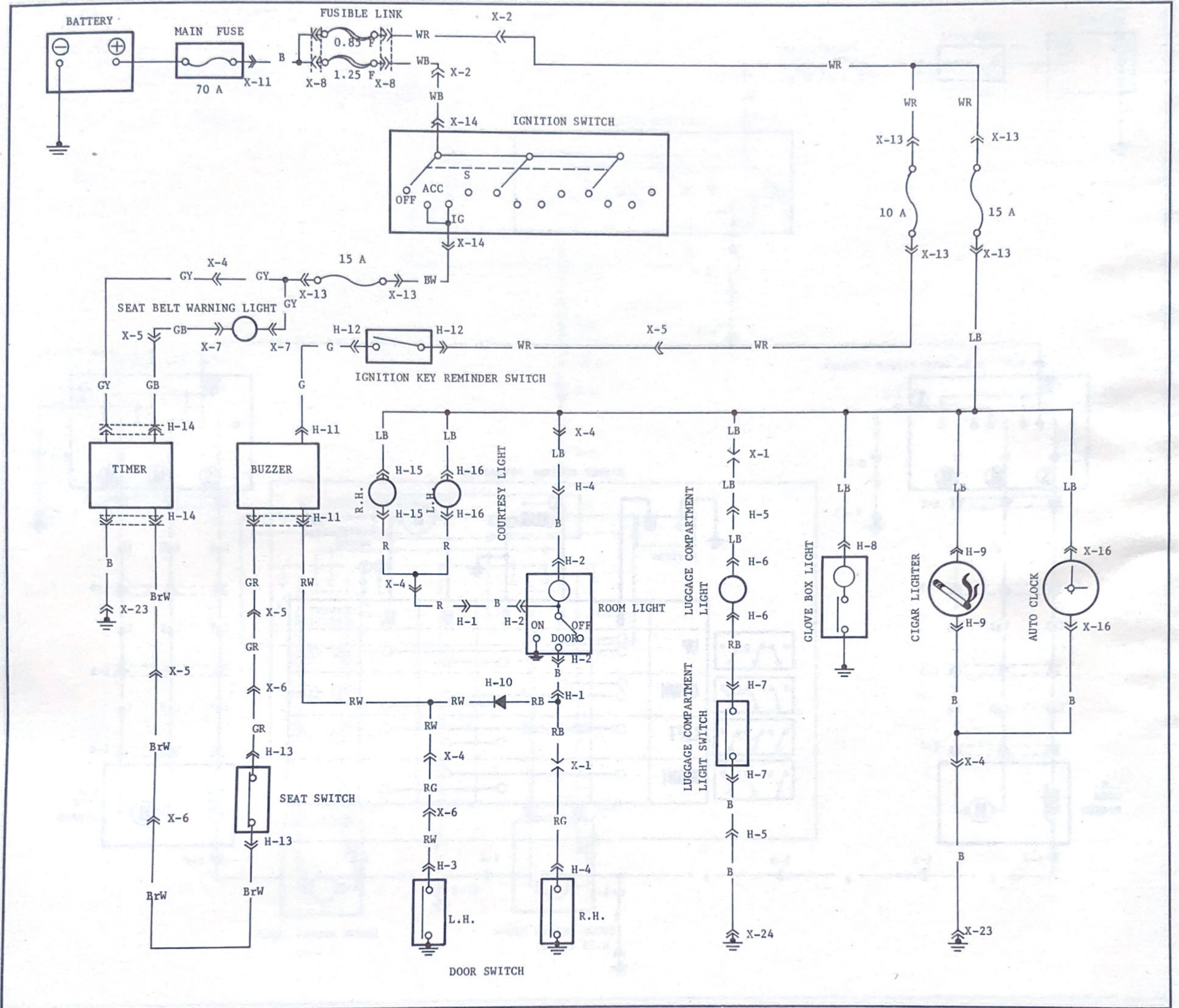

<p>H-1 CONNECTOR TO ROOM LIGHT</p> <p>UNDER DASHBOARD RIGHT</p>	<p>H-2 ROOM LIGHT</p> <p>AT ROOM LIGHT</p>	<p>H-3 DOOR SWITCH (L.H.)</p> <p>BOTTOM OF LEFT CENTER PILLAR</p>	<p>H-4 DOOR SWITCH (R.H.)</p> <p>BOTTOM OF RIGHT CENTER PILLAR</p>
<p>H-5 CONNECTOR TO LUGGAGE COMPARTMENT LIGHT</p> <p>IN LUGGAGE COMPARTMENT LEFT</p>	<p>H-6 LUGGAGE COMPARTMENT LIGHT</p> <p>IN LUGGAGE COMPARTMENT LEFT</p>	<p>H-7 LUGGAGE COMPARTMENT LIGHT SWITCH</p> <p>IN LUGGAGE COMPARTMENT LEFT</p>	<p>H-8 GLOVE BOX LIGHT</p> <p>BEHIND CENTER PANEL</p>
<p>H-9 CIGAR LIGHTER</p> <p>BEHIND CIGAR LIGHTER</p>	<p>H-10 DIODE</p> <p>AROUND STEERING COLUMN SHAFT UNDER</p>	<p>H-11 BUZZER</p> <p>AROUND STEERING COLUMN SHAFT UNDER</p>	<p>H-12 IGNITION KEY REMINDER SWITCH</p> <p>AROUND STEERING COLUMN SHAFT UNDER</p>
<p>H-13 SEAT SWITCH</p> <p>UNDER REAR CONSOLE</p>	<p>H-14 TIMER</p> <p>UNDER DASH BOARD</p>	<p>H-15 COURTESY LIGHT (R.H.)</p> <p>UNDER DASH BOARD RIGHT END</p>	<p>H-16 COURTESY LIGHT (L.H.)</p> <p>UNDER DASH BOARD LEFT END</p>

•REMOTE CONTROL DOOR MIRROR SYSTEM

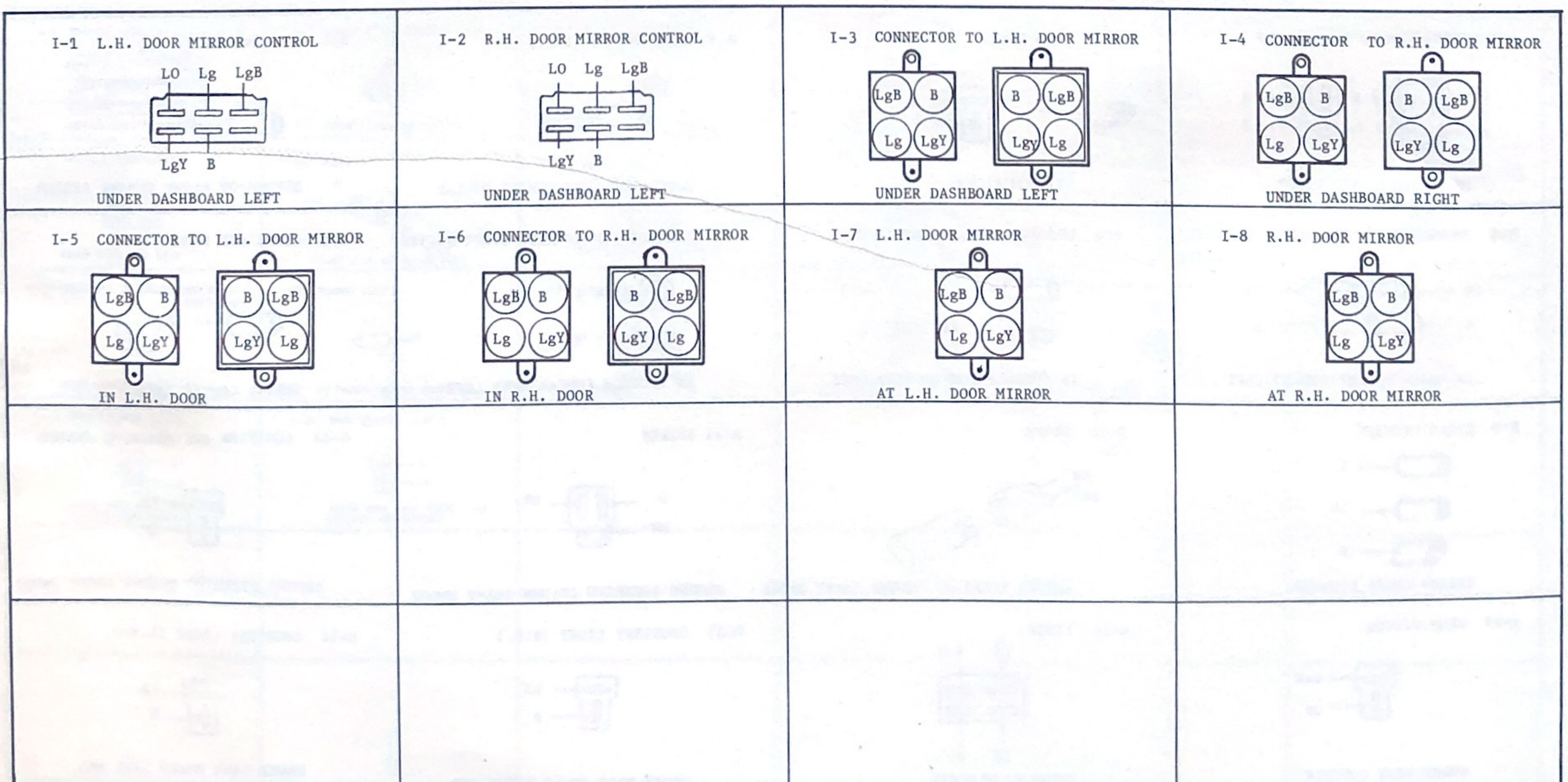
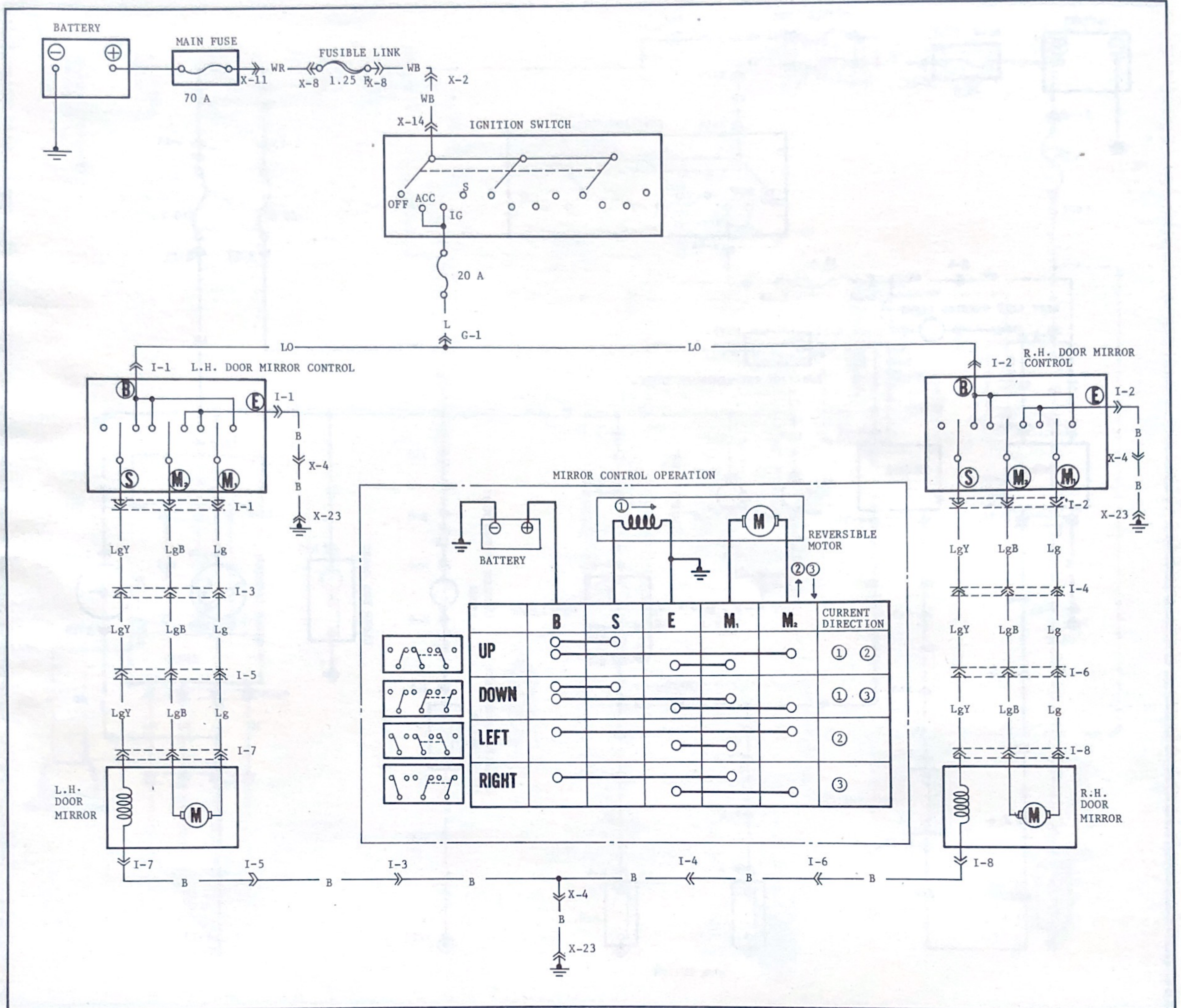

•POWER WINDOW SYSTEM

J

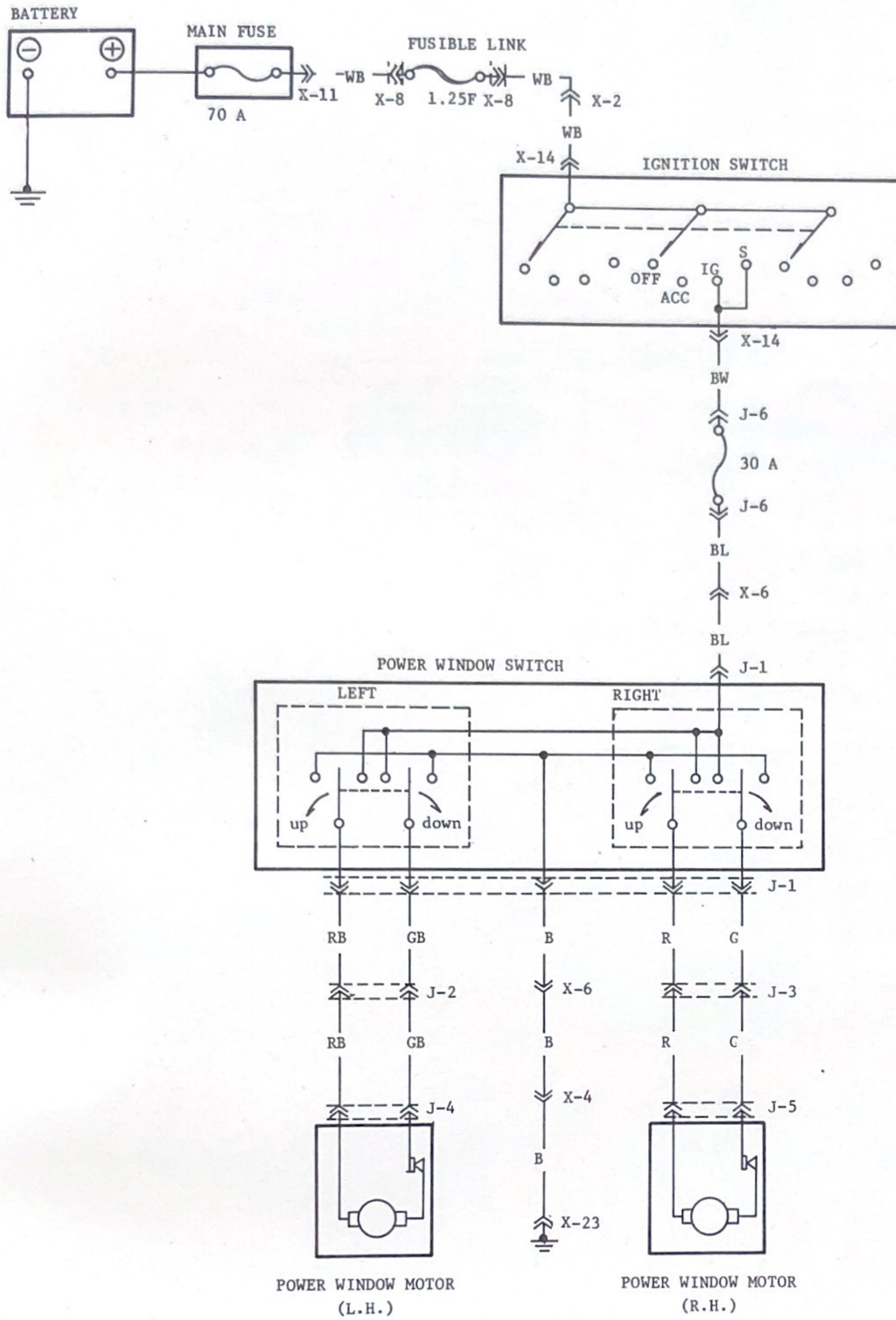

<p>J-1 POWER WINDOW SWITCH</p> <p>IN REAR CONSOLE BOX</p>	<p>J-2 CONNECTOR TO POWER WINDOW MOTOR (L.H.)</p> <p>UNDER DASHBOARD LEFT END</p>	<p>J-3 CONNECTOR TO POWER WINDOW MOTOR (R.H.)</p> <p>UNDER DASHBOARD RIGHT END</p>	<p>J-4 POWER WINDOW MOTOR (L.H.)</p> <p>IN L.H. DOOR</p>
<p>J-5 POWER WINDOW MOTOR (R.H.)</p> <p>IN R.H. DOOR</p>	<p>J-6 FUSE HOLDER</p> <p>UNDER DASHBOARD RIGHT</p>	<p>J-7 STEP LIGHT (L.H.)</p> <p>UNDER DASHBOARD LEFT END</p>	<p>J-8 STEP LIGHT (R.H.)</p> <p>UNDER DASHBOARD RIGHT END</p>

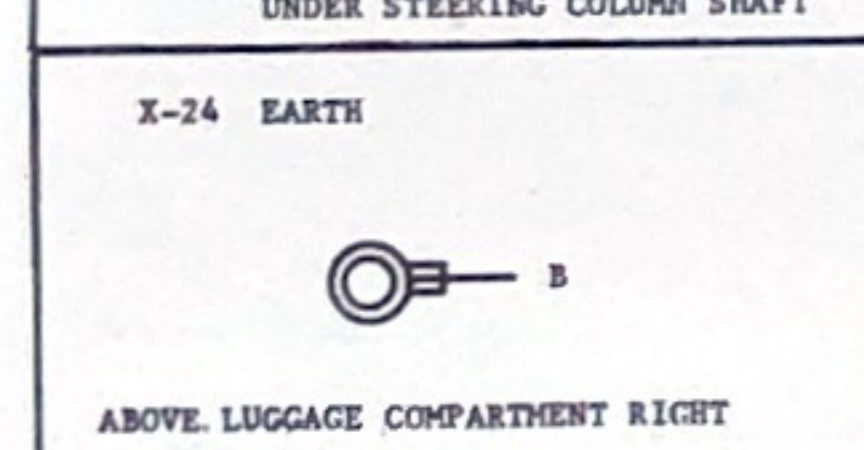
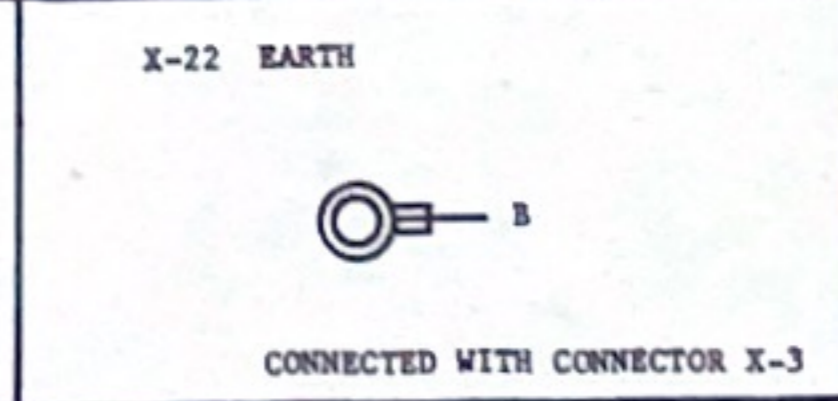
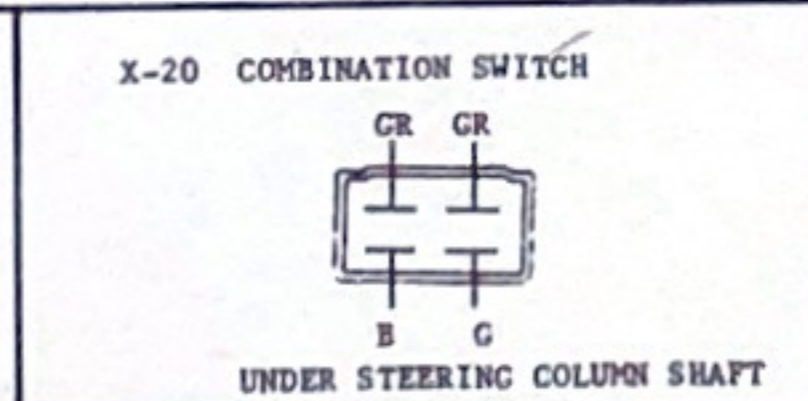
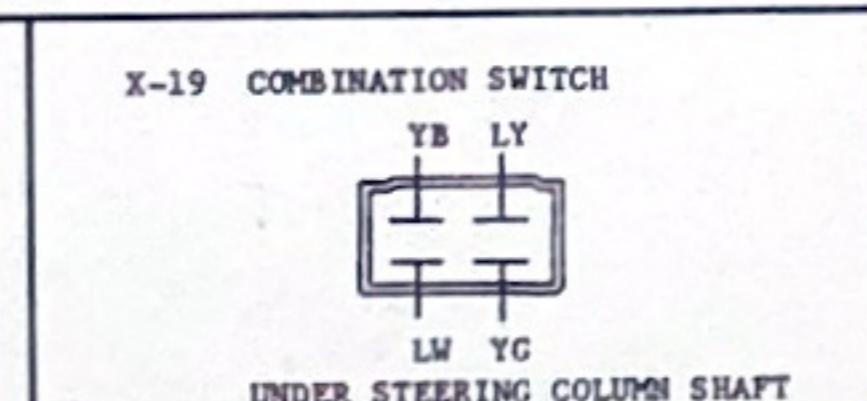
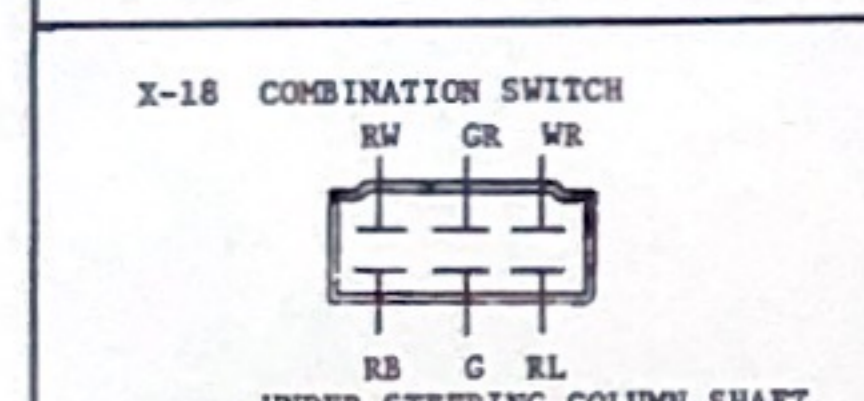
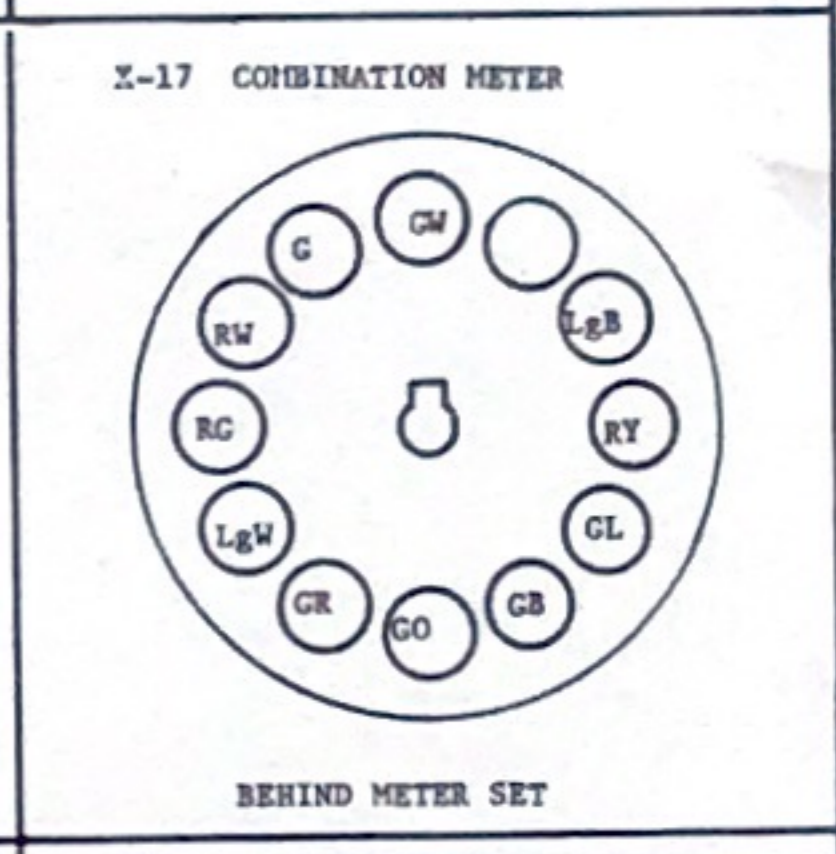
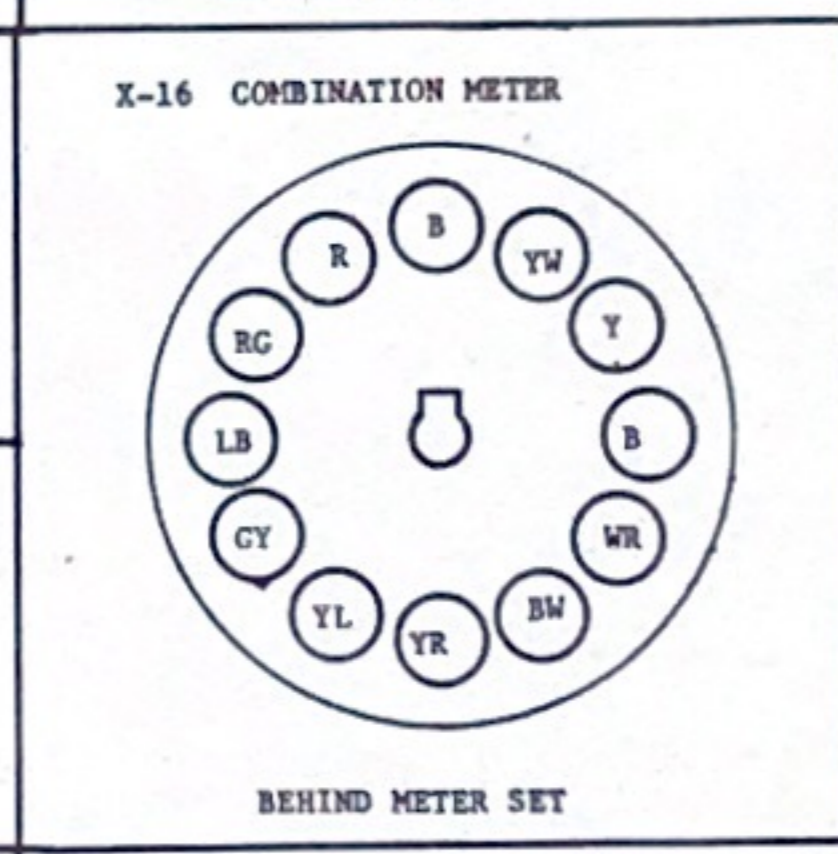
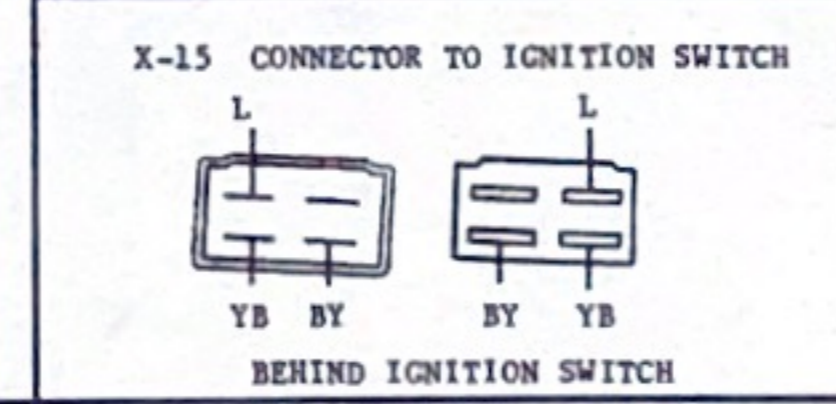
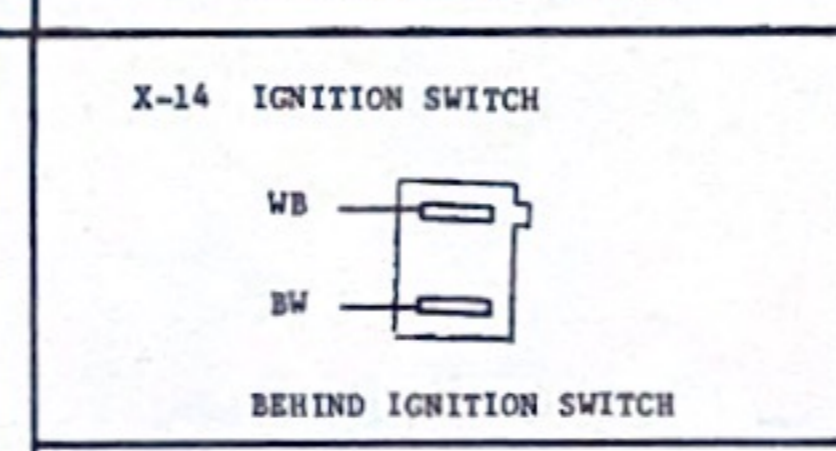
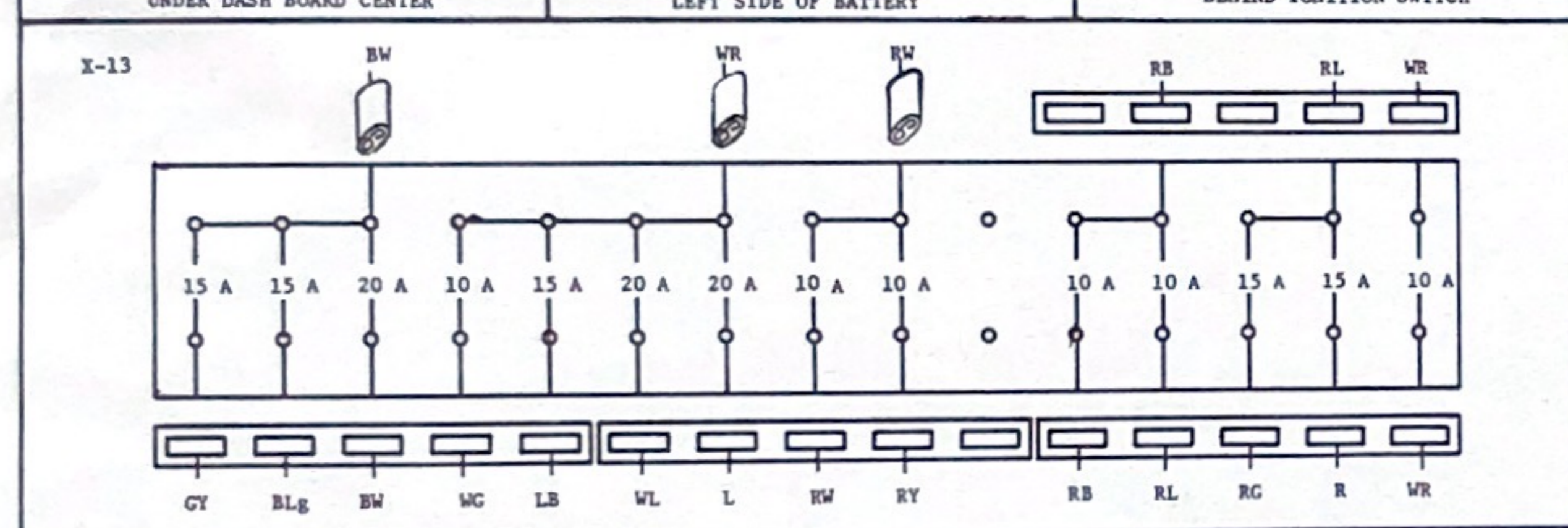
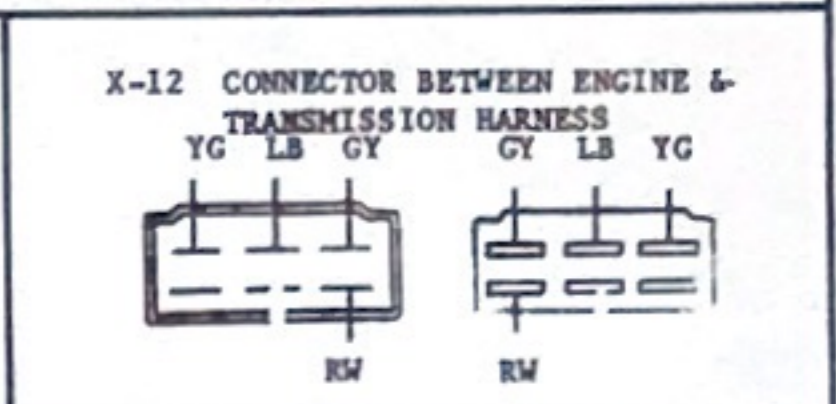
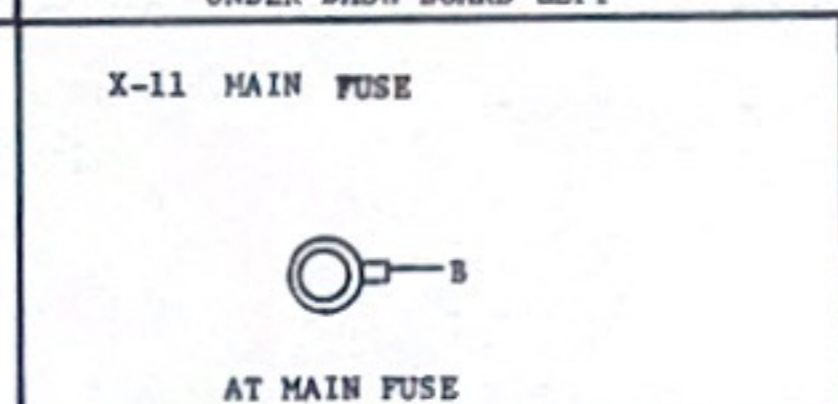
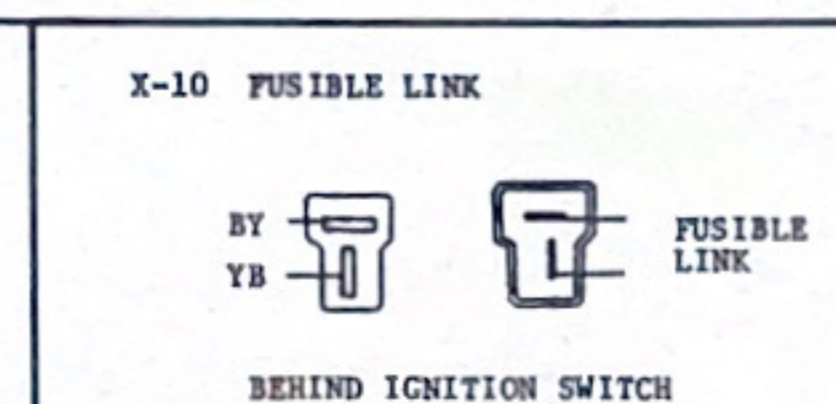
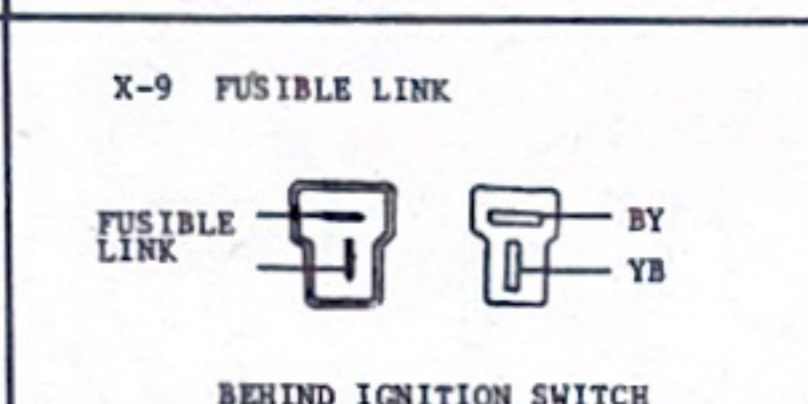
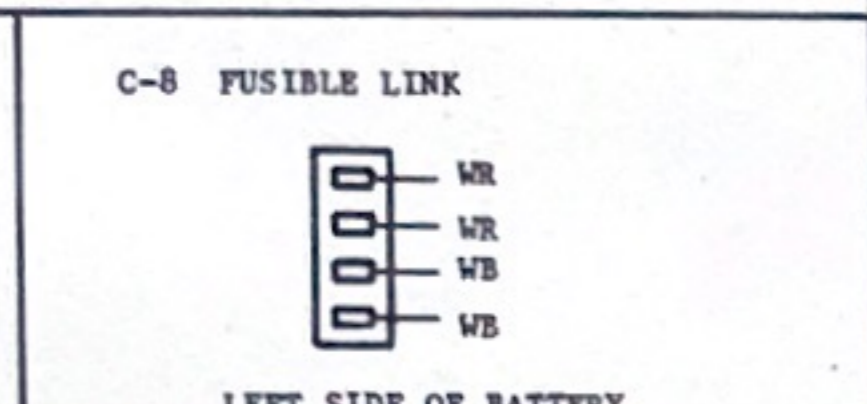
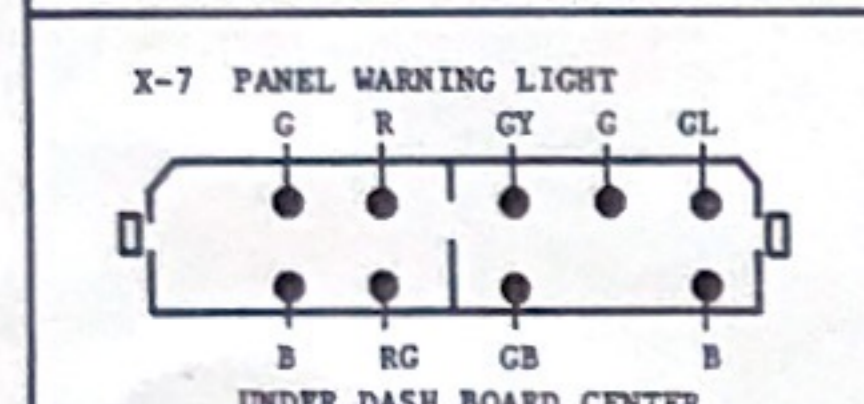
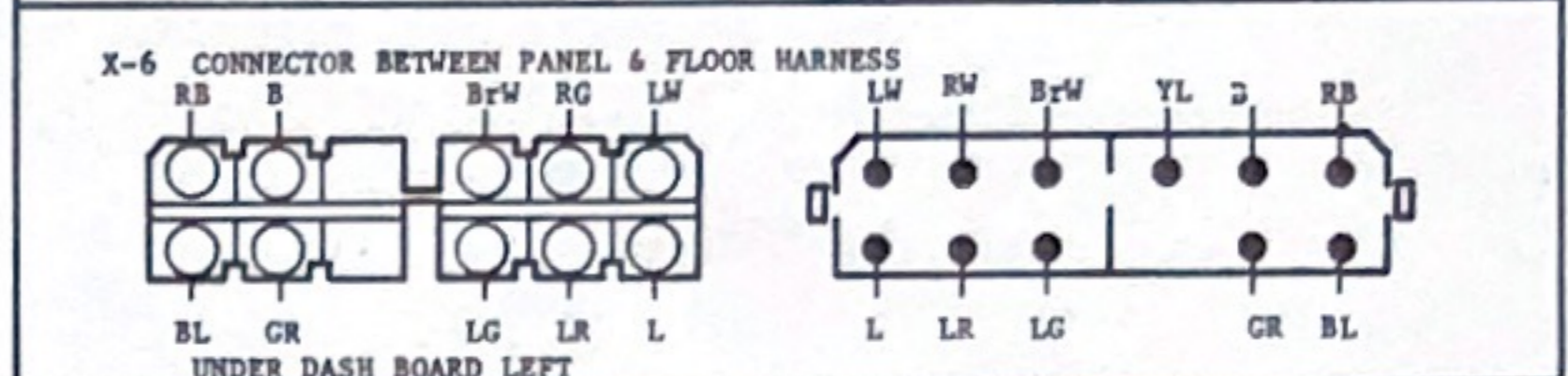
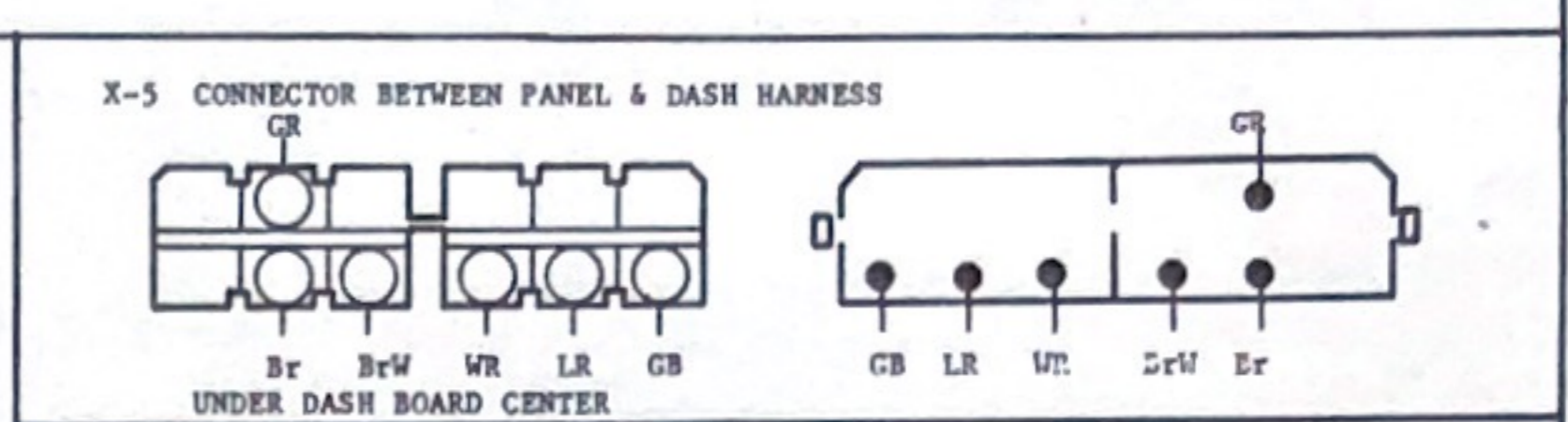
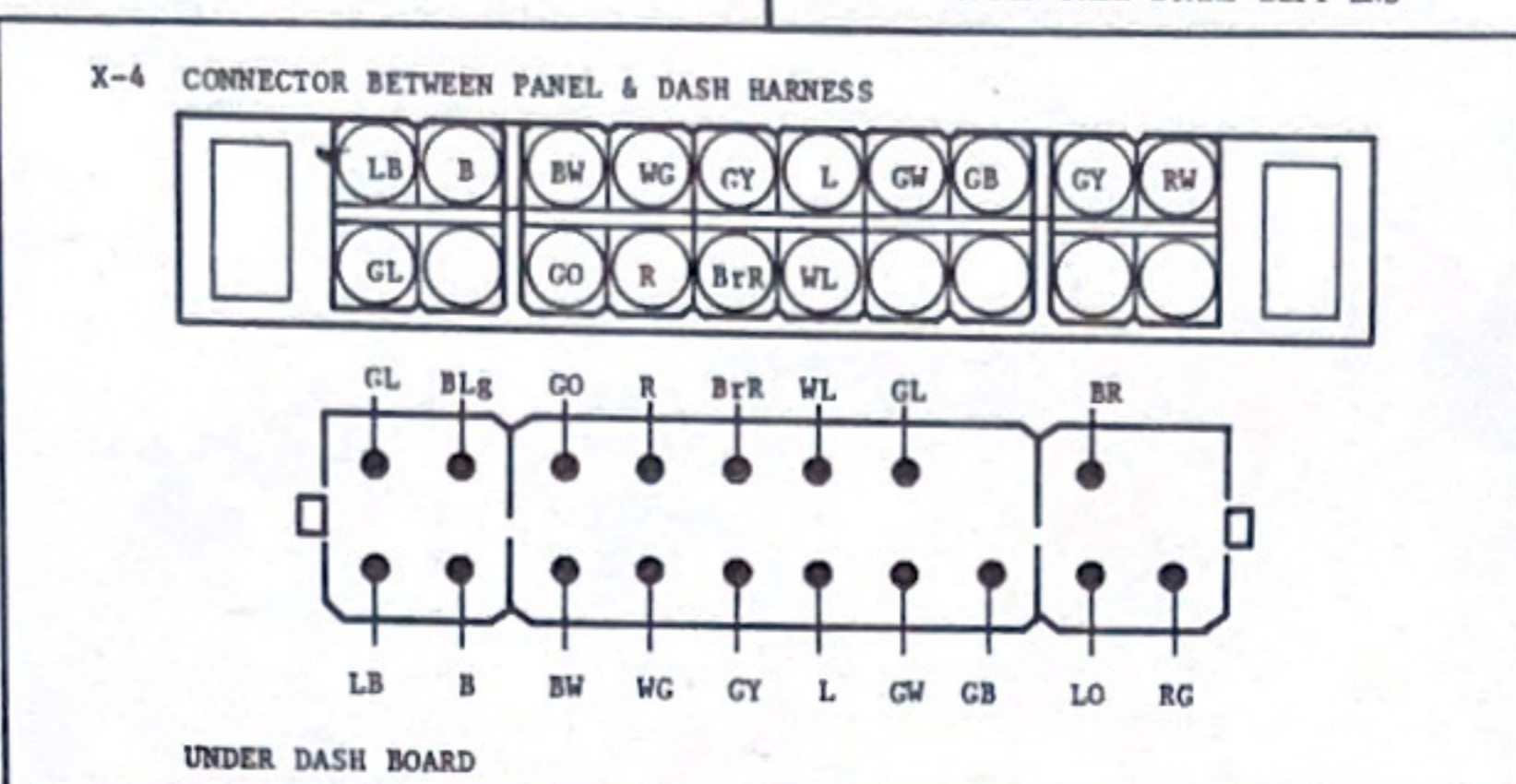
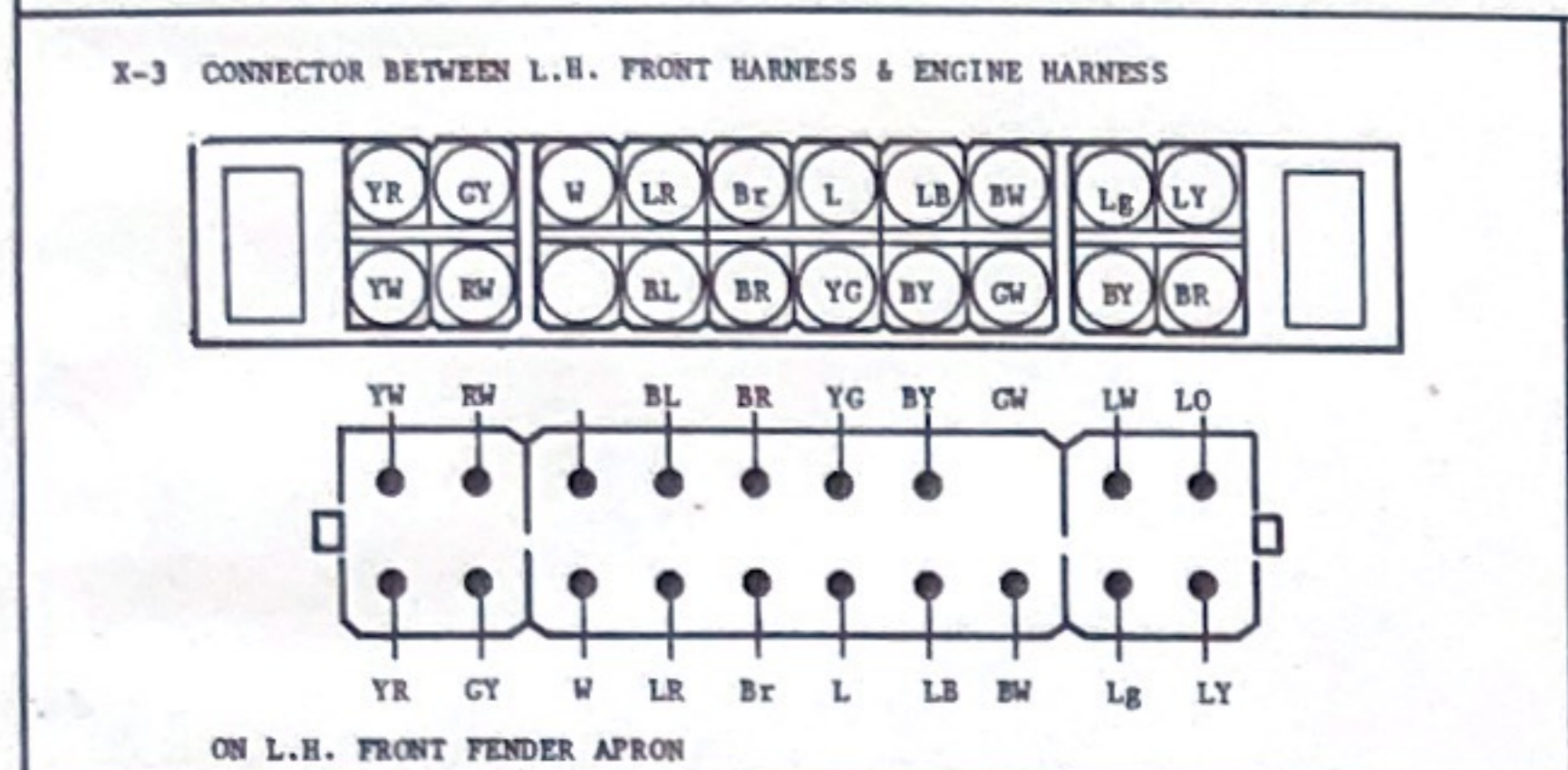
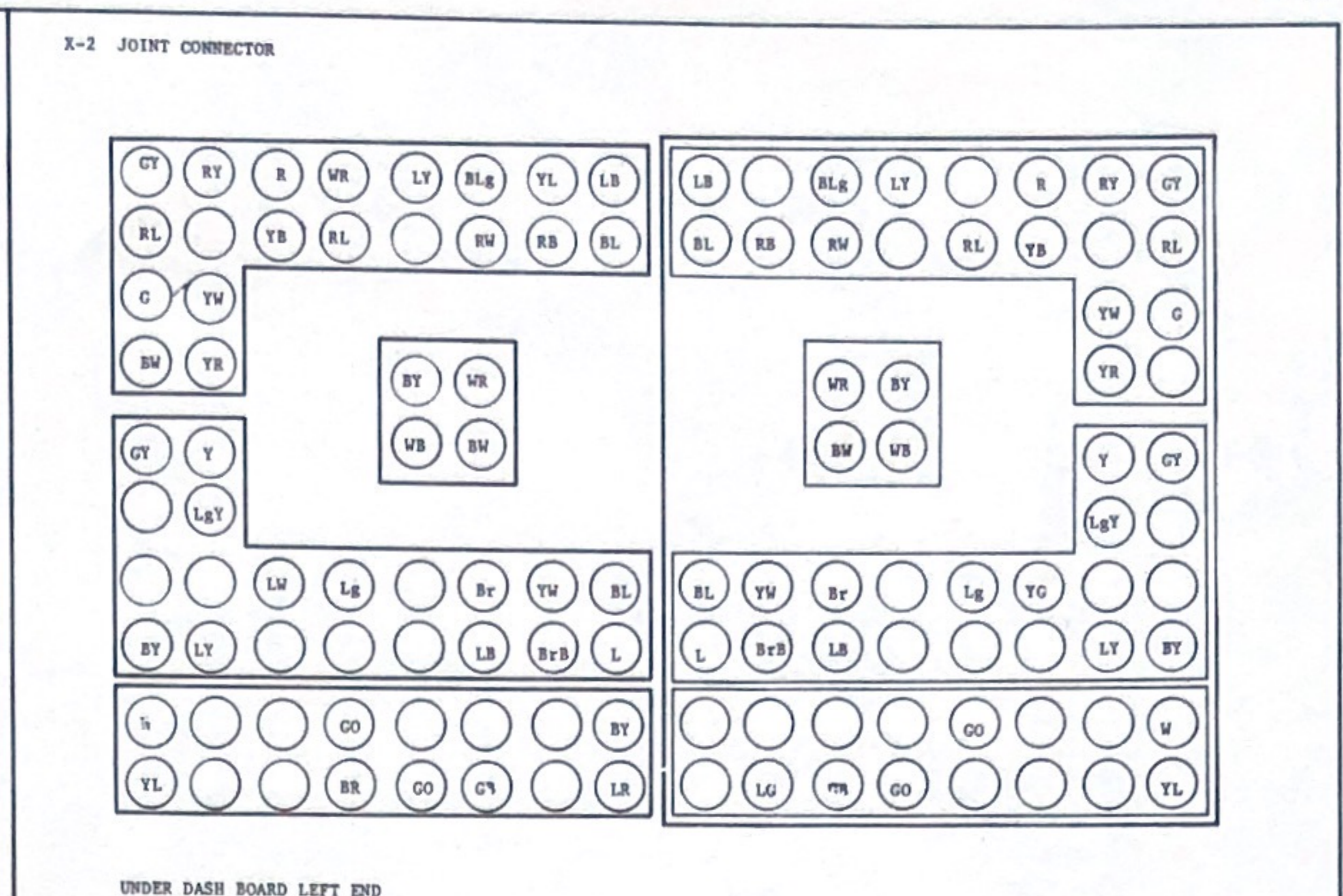
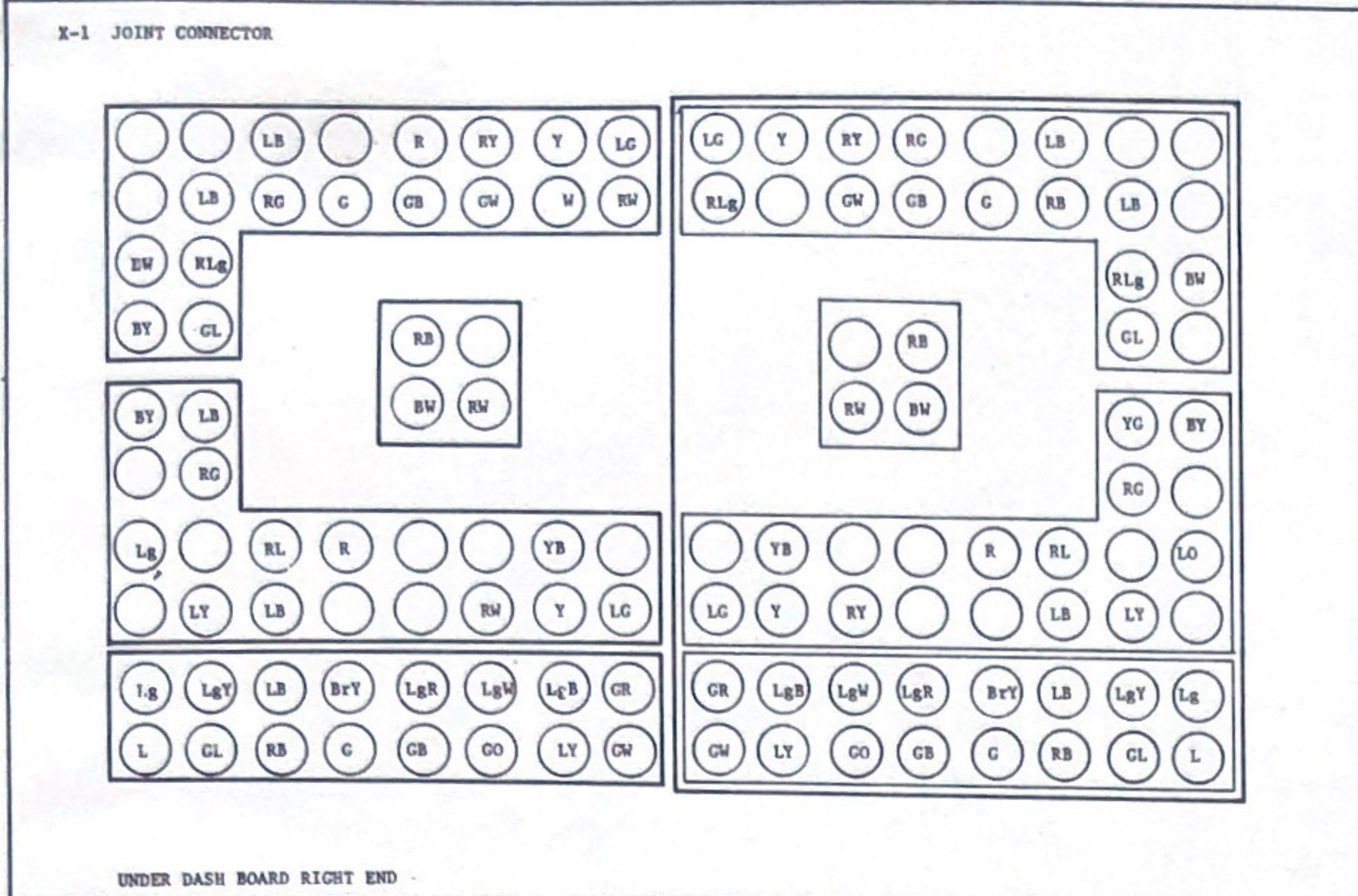

Toyo Kogyo Co.,Ltd.

© 1976 Printed in Japan

5523-10-76J LE-FUC