



MAZDA

R100 COUPÉ

WORKSHOP MANUAL

SECTION INDEX

Part	Section
Engine	1
Air Pollution Control System	1 A
Lubricating System	2
Cooling System	3
Fuel System	4
Electrical System	5
Clutch	6
Transmission & Changing System	7
Propeller Shaft	8
Rear Axle	9
Brake	10
Steering	11
Wheels & Tires	12
Suspension	13
Body	14
Technical Data	T

TOYO KOGYO CO., LTD.
HIROSHIMA JAPAN



ENGINE

(LICENSE NSU-WANKEL)

1-A. REMOVING THE ENGINE	1 : 4	1-D-9. Installing the	
1-B. DISASSEMBLING THE ENGINE	1 : 7	Front Housing	1 : 28
1-C. ENGINE INSPECTION		1-D-10. Tightening the	
AND REPAIR	1 : 11	Tension Bolts	1 : 28
1-C-1. Front Housing	1 : 11	1-D-11. Adjustment of Eccentric	
1-C-2. Intermediate Housing	1 : 14	Shaft End Play	1 : 29
1-C-3. Rear Housing	1 : 14	1-D-12. Installing the Front Cover	1 : 29
1-C-4. Rotor Housing	1 : 15	1-D-13. Installing the	
1-C-5. Rotor	1 : 16	Metering Pump	1 : 30
1-C-6. Seals and Springs.....	1 : 20	1-D-14. Installing the Oil	
1-C-7. Eccentric Shaft.....	1 : 22	Strainer and Oil Pan.....	1 : 30
1-D. ENGINE ASSEMBLY	1 : 24	1-D-15. Installing the	
1-D-1. Installing the Oil Seals	1 : 24	Clutch Assembly	1 : 31
1-D-2. Installing the Seals	1 : 25	1-D-16. Installing the Eccentric	
1-D-3. Installing the Rear Rotor	1 : 26	Shaft Pulley.....	1 : 31
1-D-4. Installing the		1-D-17. Installing the Oil Filter	1 : 32
Rear Rotor Housing	1 : 26	1-D-18. Installing the Distributors	1 : 32
1-D-5. Installing the Seals	1 : 27	1-D-19. Installing the Water Pump.....	1 : 33
1-D-6. Installing the		1-D-20. Installing the Alternator	1 : 33
Eccentric Shaft	1 : 28	1-D-21. Installing the Manifold	
1-D-7. Installing the		and Carburettor	1 : 33
Intermediate Housing ...	1 : 28	1-E. ENGINE INSTALLATION.....	1 : 33
1-D-8. Installing the Front			
Rotor and Housing.....	1 : 28		

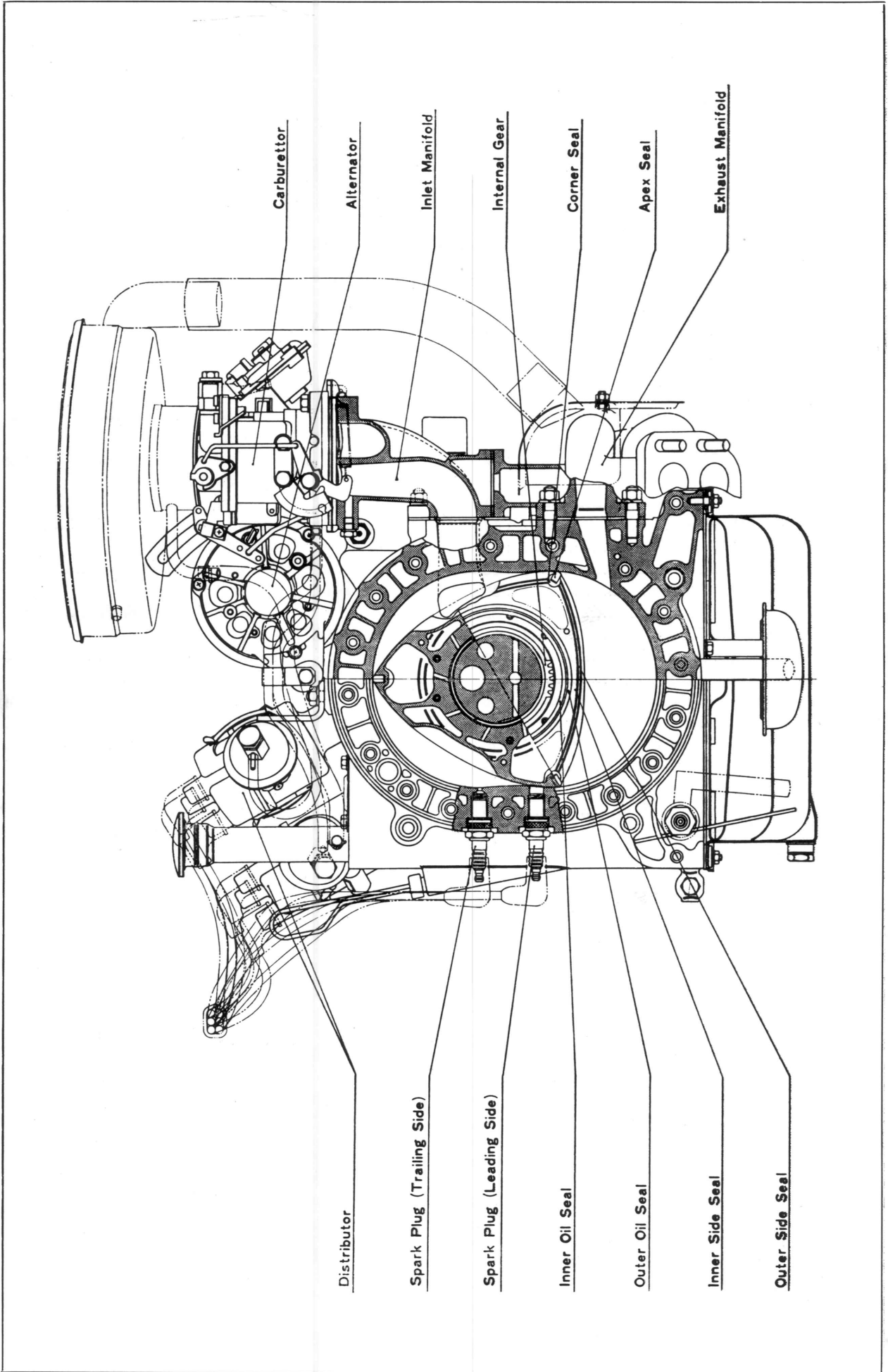
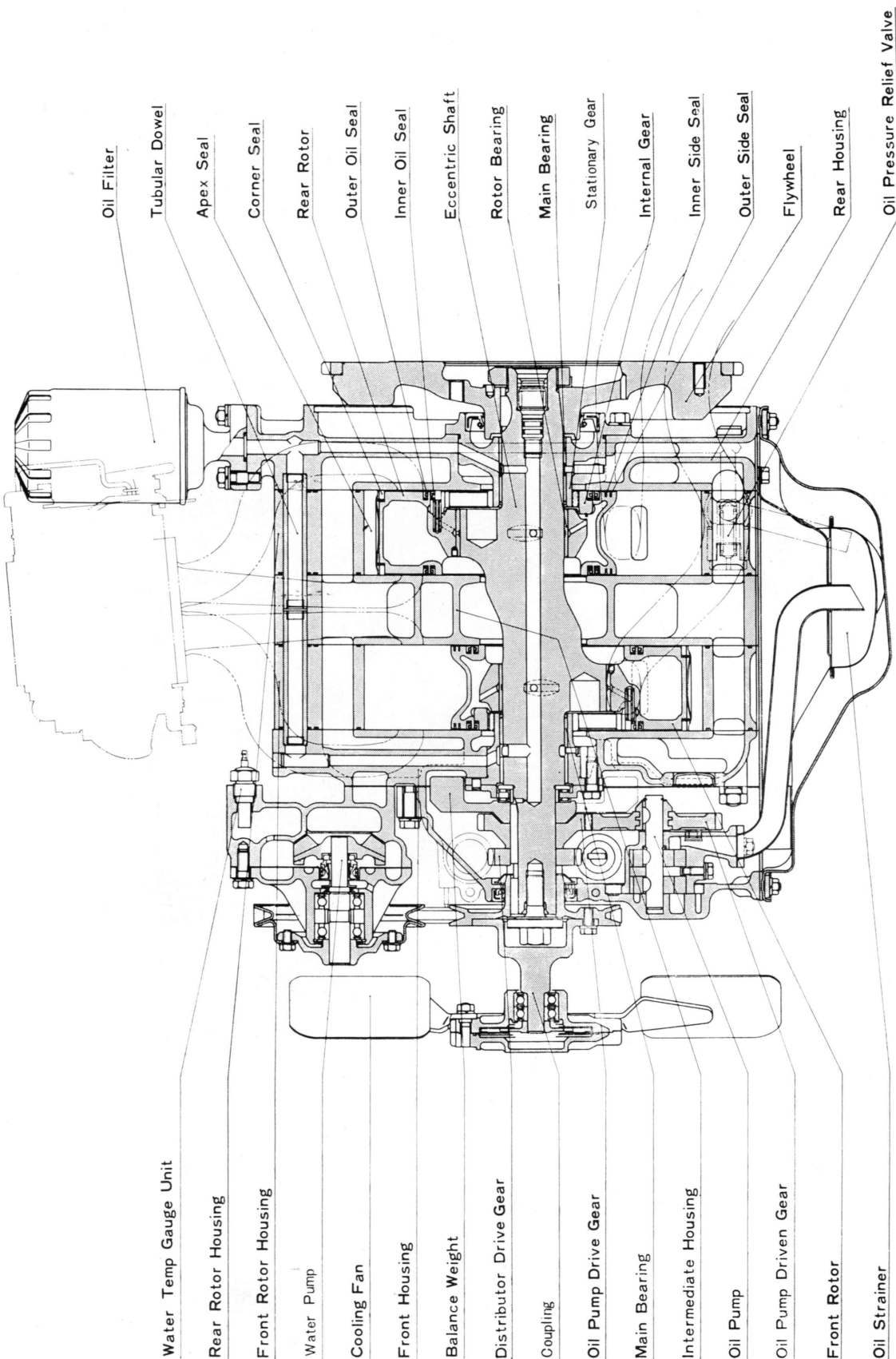

Fig. 1-1 Engine (1)



- Water Temp Gauge Unit
- Rear Rotor Housing
- Front Rotor Housing
- Water Pump
- Cooling Fan
- Front Housing
- Balance Weight
- Distributor Drive Gear
- Coupling
- Oil Pump Drive Gear
- Main Bearing
- Intermediate Housing
- Oil Pump
- Oil Pump Driven Gear
- Front Rotor
- Oil Strainer
- Oil Filter
- Tubular Dowel
- Apex Seal
- Corner Seal
- Rear Rotor
- Outer Oil Seal
- Inner Oil Seal
- Eccentric Shaft
- Rotor Bearing
- Main Bearing
- Stationary Gear
- Internal Gear
- Inner Side Seal
- Outer Side Seal
- Flywheel
- Rear Housing
- Oil Pressure Relief Valve

Fig. 1-2 Engine (2)

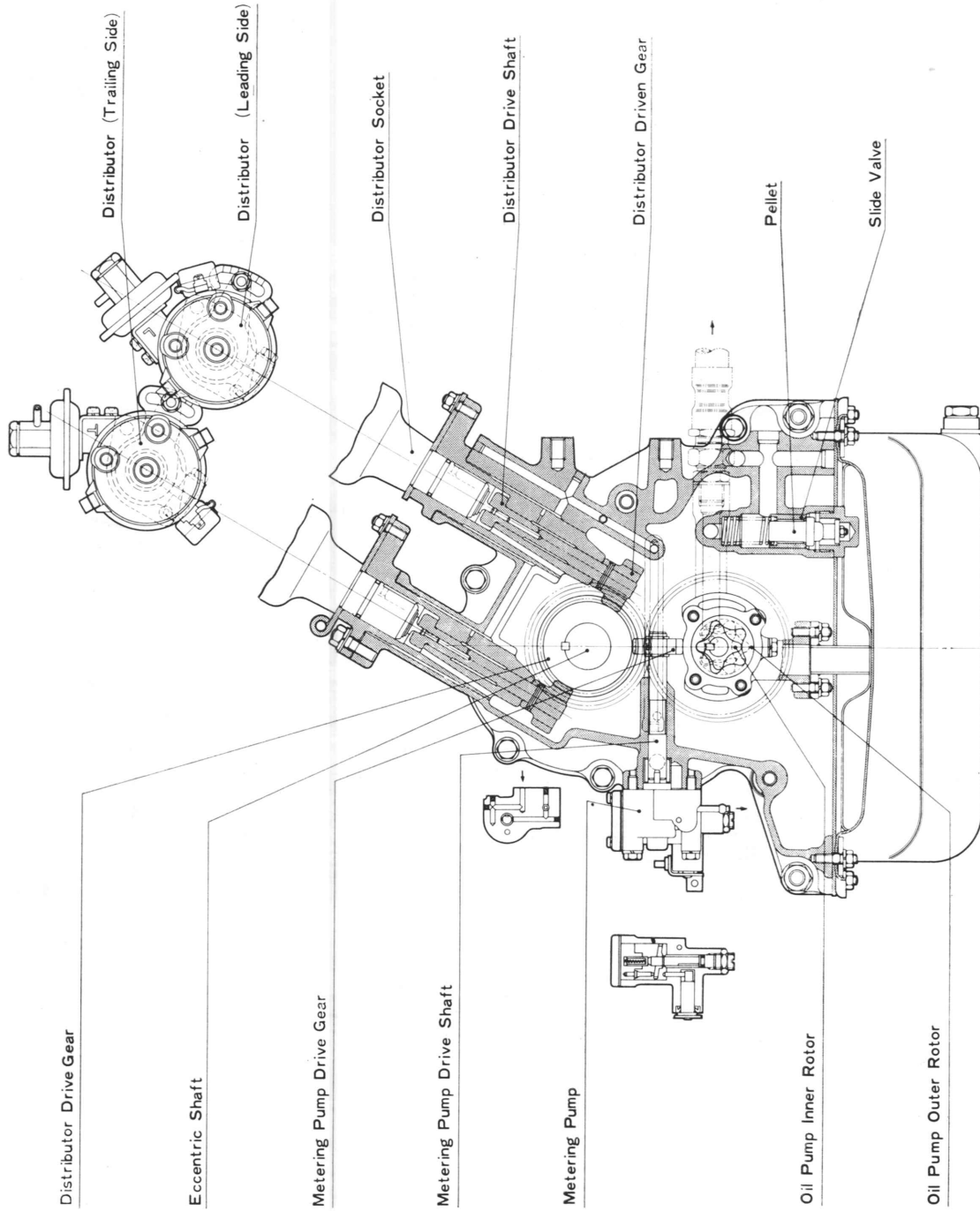

Fig. 1-8 Engine (3)

ENGINE

MAZDA R100 Coupé is mounted with a 2-rotor type rotary piston engine of Toyo Kogyo's unique design. Its single chamber capacity is 491 cc (29.96 cu. in) and the compression ratio is 9.4 : 1. The performance is shown in Fig. 1-4.

The main component parts of the rotary piston engine are entirely different from those of the conventional reciprocating engine. The rotor which corresponds to the piston of the reciprocating engine makes a rotary motion due to the explosion pressure occurring in the chamber formed by the rotor housing and the side housings which correspond to the cylinder of the reciprocating engine. This rotary motion of the rotor is converted into the rotary motion of the eccentric shaft and is then produced as output through the flywheel.

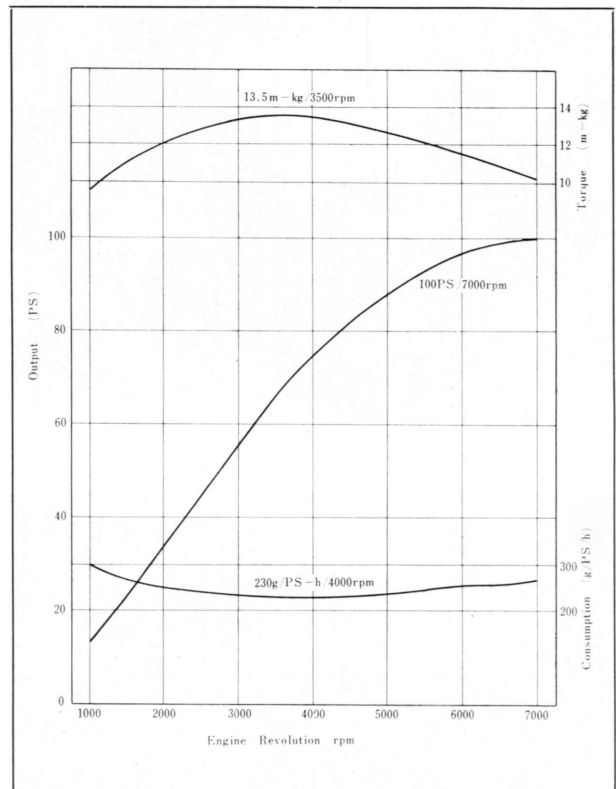

Fig. 1-4 Engine performance curve

1-A. REMOVING THE ENGINE

To remove the engine for overhauling, proceed as described in the following:

1. Remove the bonnet.
2. Protect the fender with a cover.
3. Drain the cooling water.
4. Drain the engine lubricating oil.
5. Remove the battery.
6. Remove the air-cleaner.
7. Remove the fuel pipe from the carburettor.
8. Disconnect the accelerator cable and the choke cable from the carburettor.

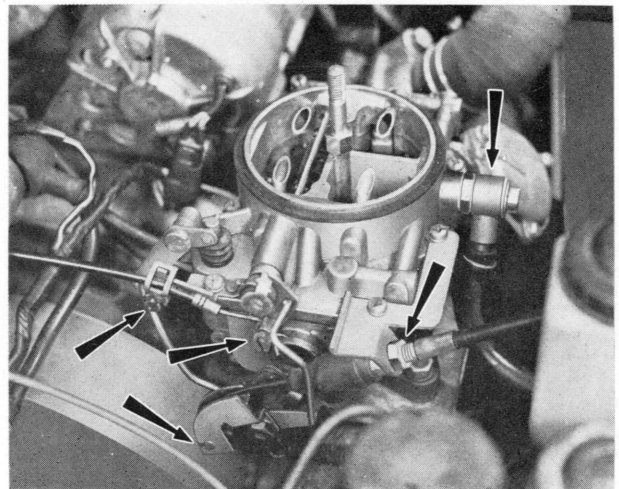

Fig. 1-5 Disconnecting pipe and cables

9. Disconnect the wiring from the starting motor.

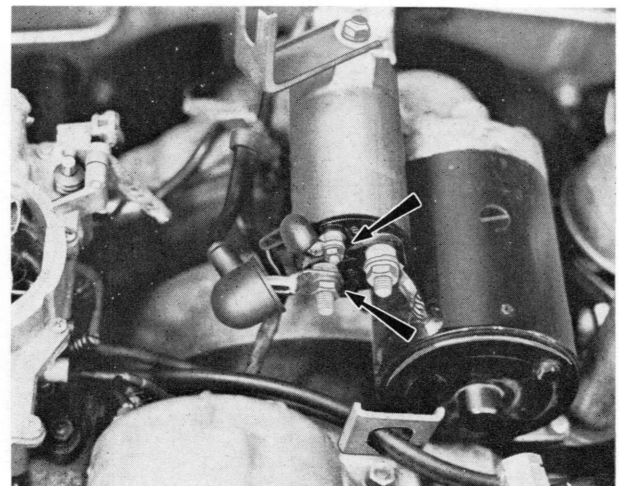

Fig. 1-6 Disconnecting wires

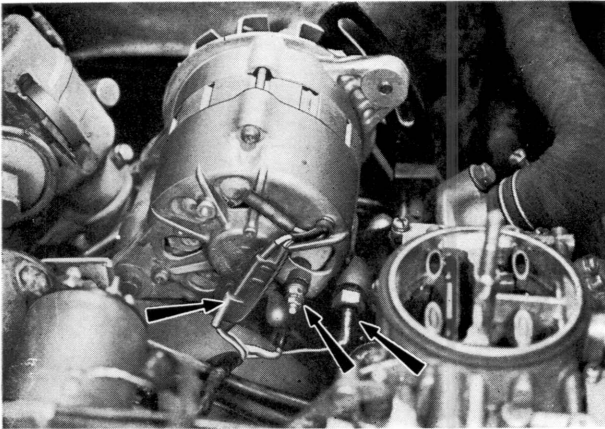

Fig. 1-7 Disconnecting wires

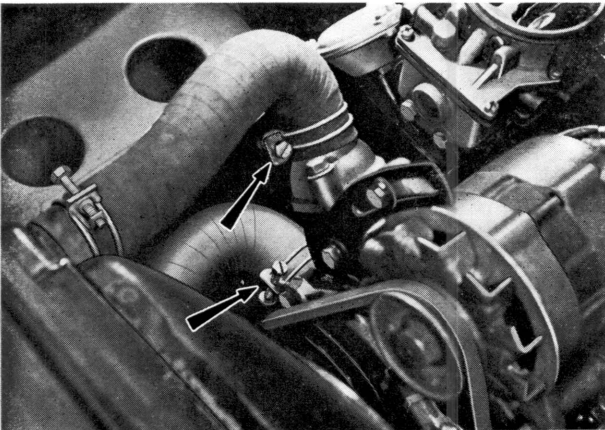

Fig. 1-8 Removing water hoses

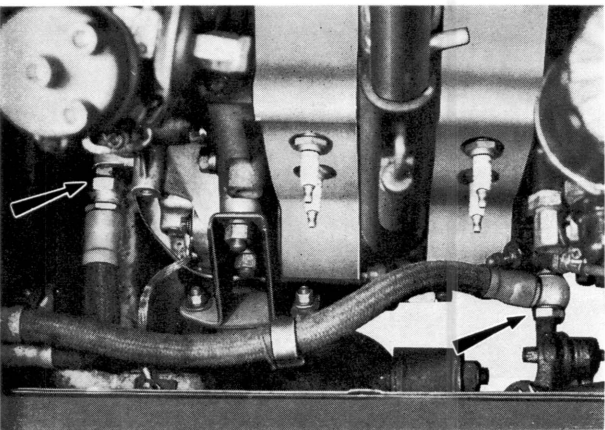

Fig. 1-9 Removing oil hoses

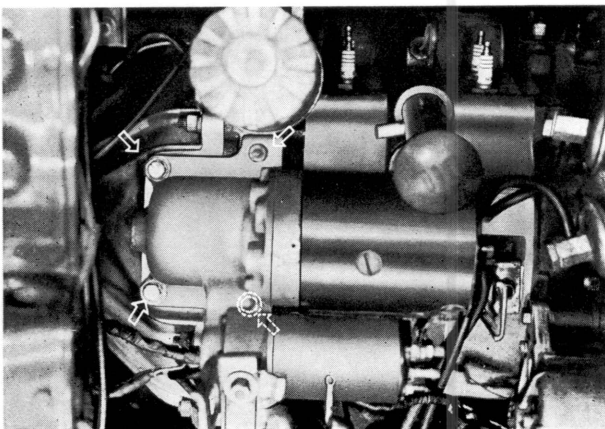

Fig. 1-10 Removing starting motor

10. Disconnect the wiring from the alternator and the water temperature gauge unit.
11. Disconnect the high-tension cables from the distributors and the spark plugs.
12. Disconnect the wiring of the oil pressure switch.

13. Remove the water hoses at the upper and lower of the radiator.
14. Remove the car-heater hose from the engine.

15. Remove the oil hoses from the front cover and rear housing of the engine.
16. Remove the horn together with its mounting bracket.
17. Remove the radiator shroud.
18. Unscrew the radiator mounting bolts and remove the radiator and oil-cooler assembly.
19. Remove the engine earth wire from the front cover of the engine.

20. Remove the starting motor.
21. Remove the clutch release cylinder and place it on the frame.

22. Disconnect the exhaust pipe from the manifold.
23. Remove the bolts securing the clutch housing to the rear housing of the engine.
24. Remove the hot air duct from the exhaust manifold.

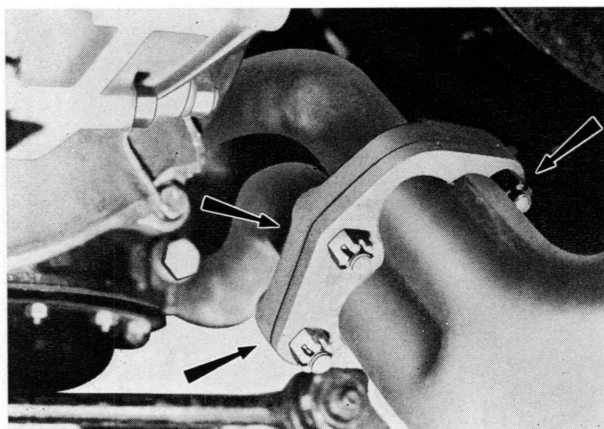

Fig. 1-11 Disconnecting exhaust pipe

25. Support the transmission with a suitable jack.
26. Remove the bolts from each engine mounting.

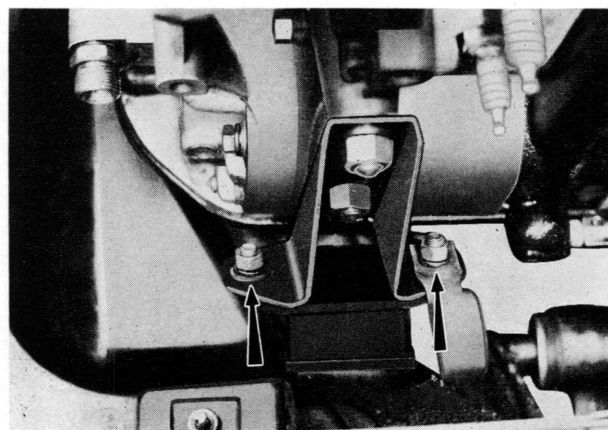

Fig. 1-12 Loosening mounting bolts

27. Install a suitable lifting sling on the engine hanger bracket of the front rotor housing. Attach the sling to a hoist or other lifting device and take up all slack.
28. Pull the engine forward until it clears the clutch shaft. Then, lift the engine from the vehicle.

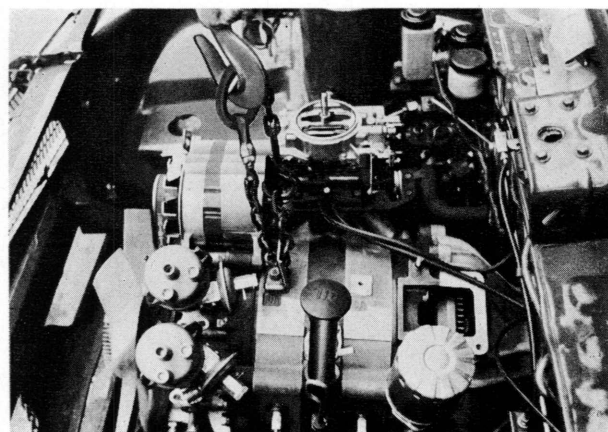

Fig. 1-13 Removing engine from vehicle

29. Remove the link from the oil metering pump.
30. Remove the intake manifold, exhaust manifold and carburettor.
31. Remove the engine bracket.
32. Mount the engine on the **engine stand** (49 0107 680A, 49 0813 005 and 49 0820 006).

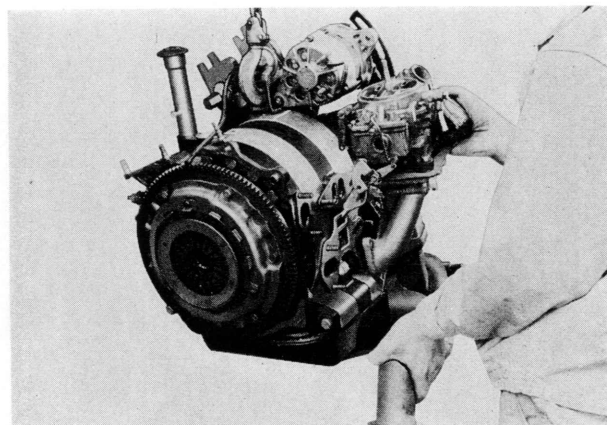

Fig. 1-14 Removing manifold and carburettor assembly

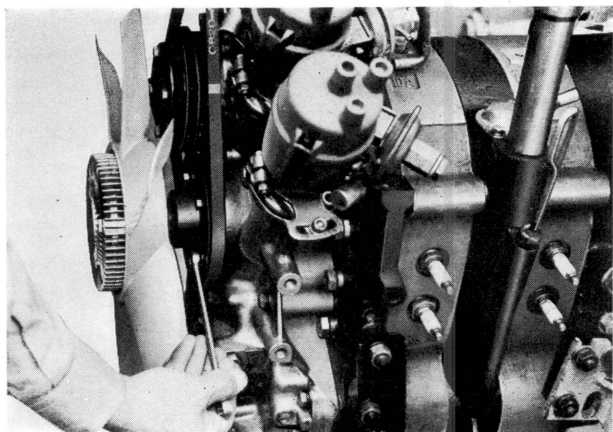

Fig. 1-15 Removing cooling fan

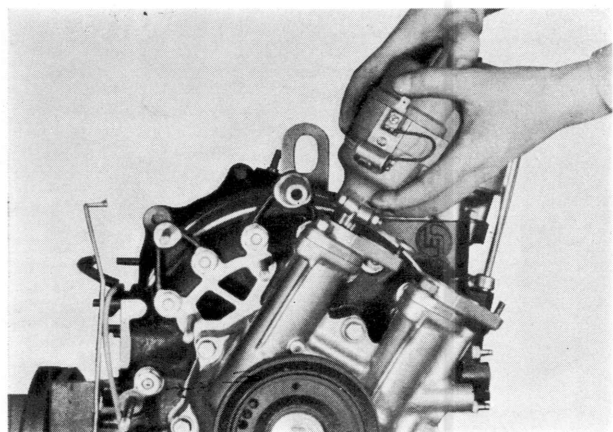

Fig. 1-16 Removing distributors

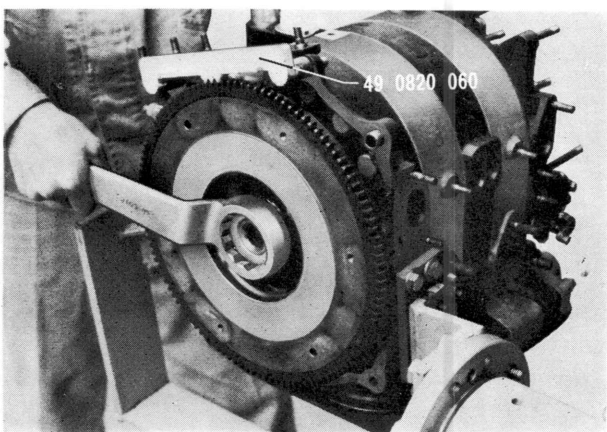

Fig. 1-17 Loosening flywheel nut

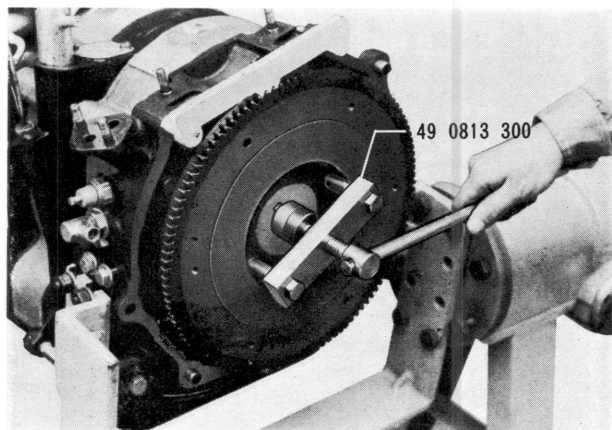

Fig. 1-18 Removing flywheel

1-B. DISASSEMBLING THE ENGINE

Engine overhaul should be done in the following order after removing the engine from the vehicle :

1. Remove the cooling fan from the eccentric shaft pulley.

2. Remove the alternator.

3. Remove the water pump pulley.

4. Remove the water pump.

5. Remove the distributors from the front cover.

6. Remove the spark plugs.

7. Remove the oil filter from the rear housing.

8. Attach the **ring gear brake** (49 0820 060) to the flywheel. Remove the eccentric shaft pulley mounting bolt and take off the pulley.

9. Remove the clutch assembly and clutch disk.

10. Straighten the tab of the lockwasher and remove the flywheel nut.

11. Remove the flywheel by using the **flywheel puller** (49 0813 300).

12. Remove the oil pan.
13. Remove the oil strainer.

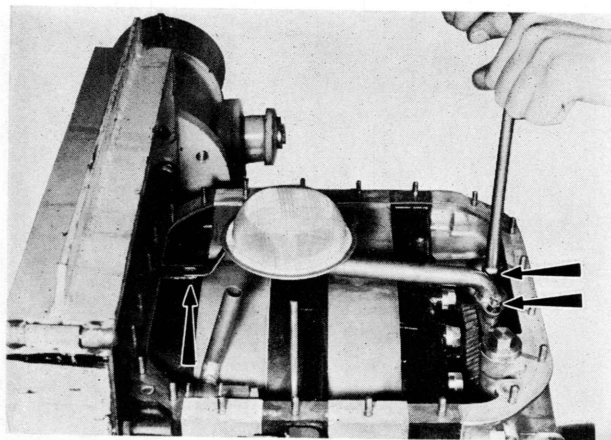

Fig. 1-19 Removing oil strainer

Note: Apply identification marks on the front and rear rotor housings, which are common parts, so that they are fitted as they were, when reassembling the engine.

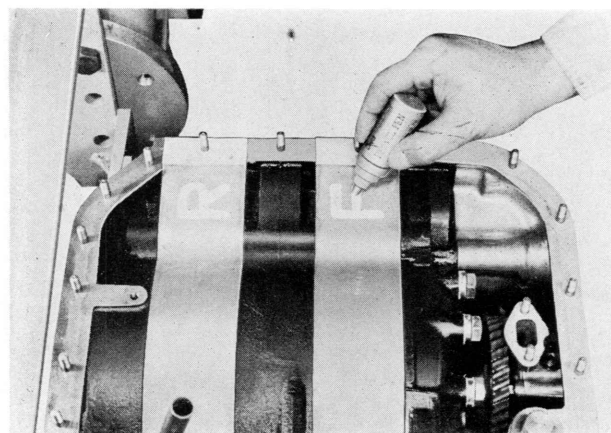

Fig. 1-20 Applying identification marks

14. Remove the oil metering pump from the front cover

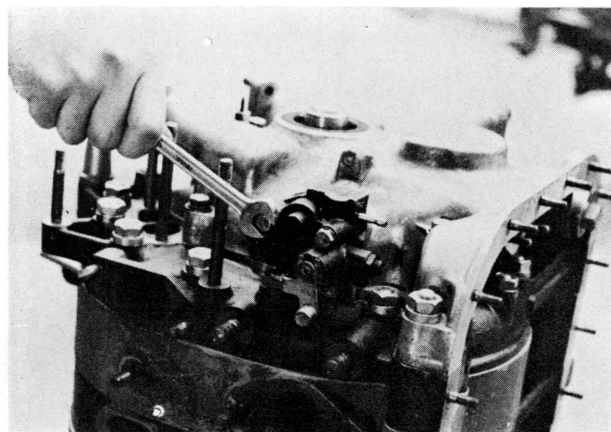

Fig. 1-21 Removing metering pump

15. Loosen the front cover attaching bolts and two tension bolts and remove the cover.

Note: These two tension bolts are of a different length than the others.

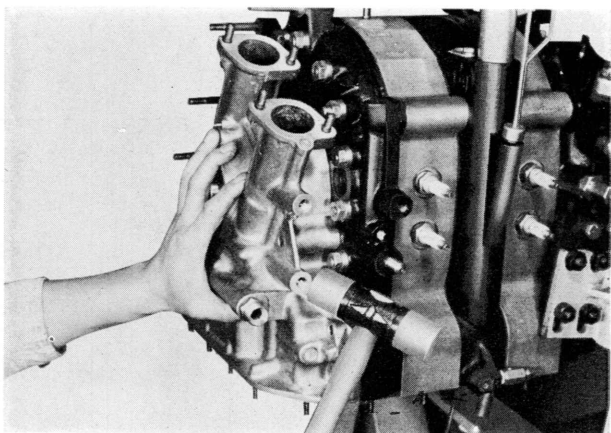

Fig. 1-22 Removing front cover

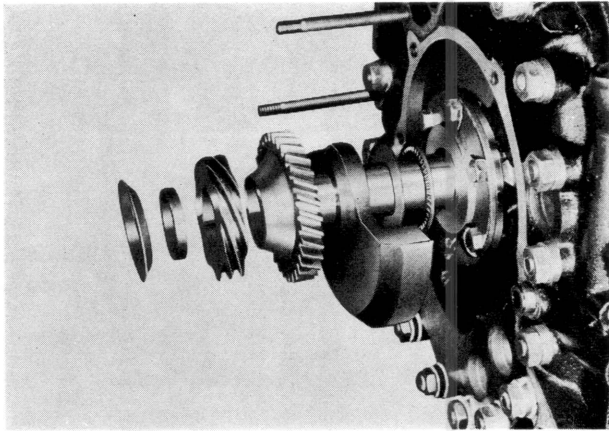

Fig. 1-23

16. Remove the spacer, distributor drive gear, oil pump drive gear, balance weight, thrust plate, and needle bearing in that order from the eccentric shaft.

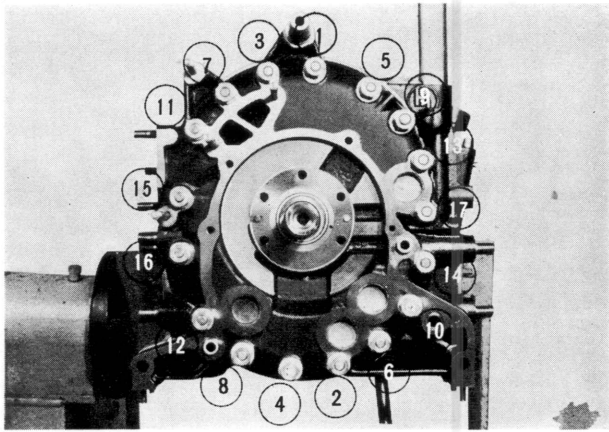

Fig. 1-24 Loosening order

17. Loosen the tension bolts in the reverse order of tightening, as shown in Fig. 1-24.

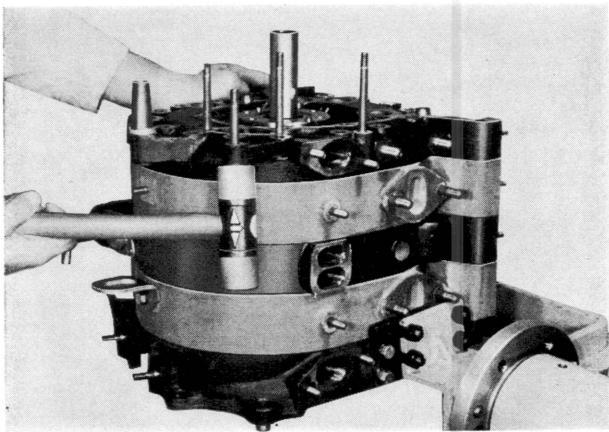

Fig. 1-25 Removing front housing

18. Remove the front housing.
19. Remove the sealing rubber and the "O" rings from between the front housing and the rotor housing.

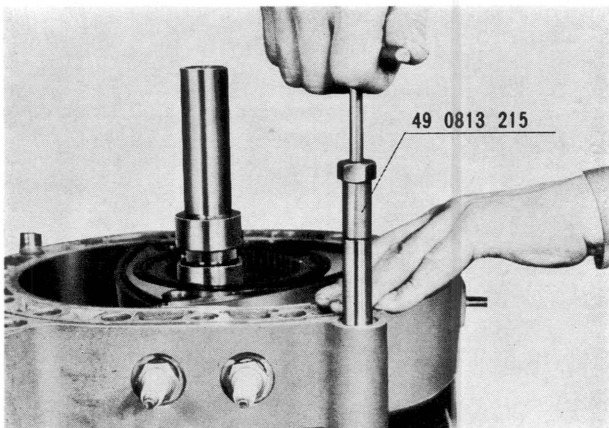

Fig. 1-26 Pulling tubular dowels

20. Hold the rotor housing down by hand to prevent it from moving up, then pull the tubular dowels by using the **dowel puller** (49 0813 215).

21. Install the **rotor clamp** (49 0813 230) by allowing the front rotor housing to move up to the required level, then remove the front rotor housing.

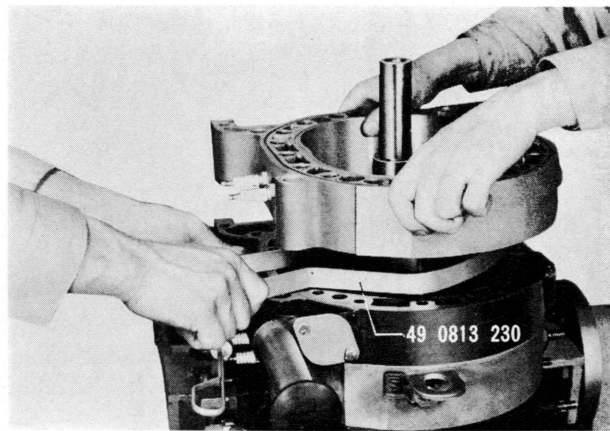

Fig. 1-27 Removing rotor housing

Note: The rotors are marked as shown in Fig. 1-28. "F" on the internal gear side indicates the front rotor, while "R" indicates the rear rotor. When assembling, be careful to these marks.

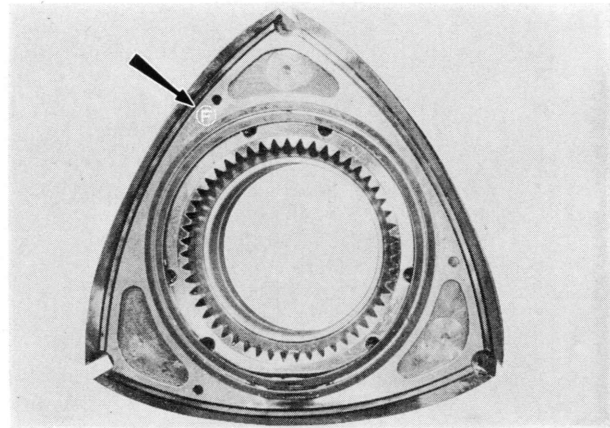

Fig. 1-28 Identification mark of rotor

22. Remove the apex seals and springs after removing the rotor clamp. When removing the apex seal, put an identification mark on the bottom of the apex seal so that, when reassembling the engine, the apex seal can be incorporated to the correct location and in the correct direction. **Never put a mark with a punch, notch or the like.**

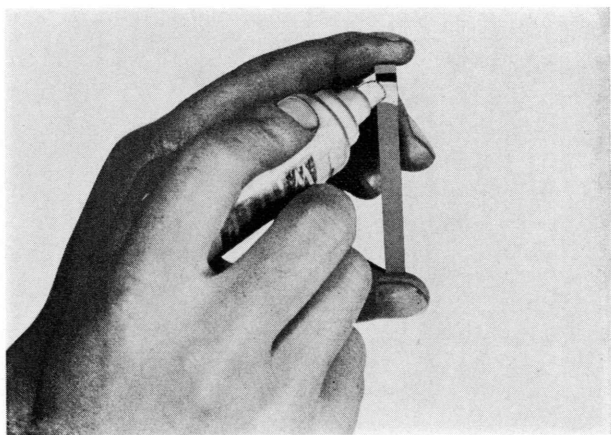

Fig. 1-29 Putting identification mark

23. Remove the corner seals, corner seal springs, side seals and side seal springs.

24. Remove the rotor from the eccentric shaft and place it upside down on a clean cloth or rubber.

Note: Be careful not to drop each seal from the reverse side of the rotor.

25. Remove the seals on the rear side of the rotor.

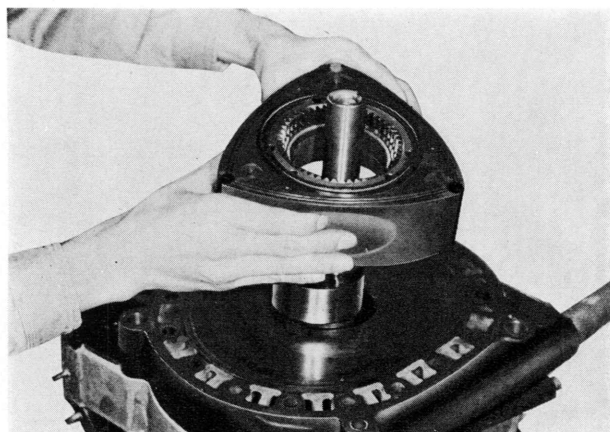

Fig. 1-30 Removing rotor

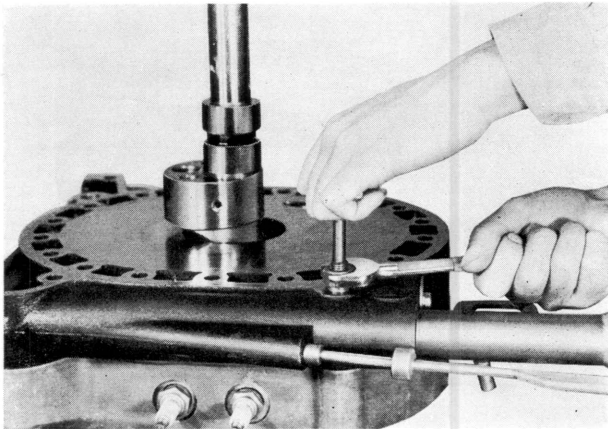

Fig. 1-31 Removing tubular dowels

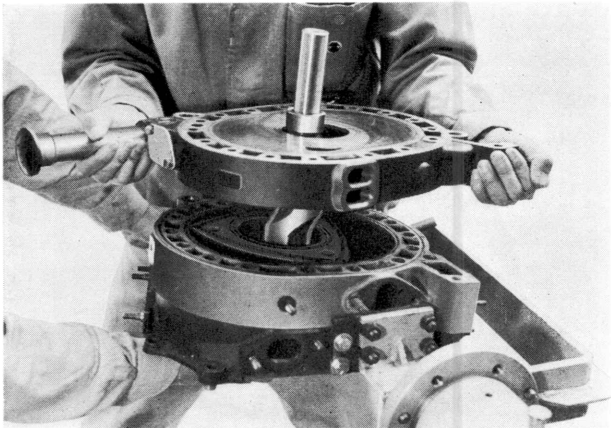

Fig. 1-32 Removing intermediate housing

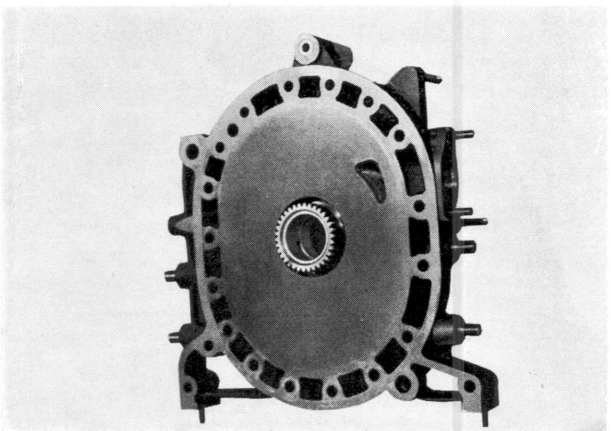

Fig. 1-33 Front housing

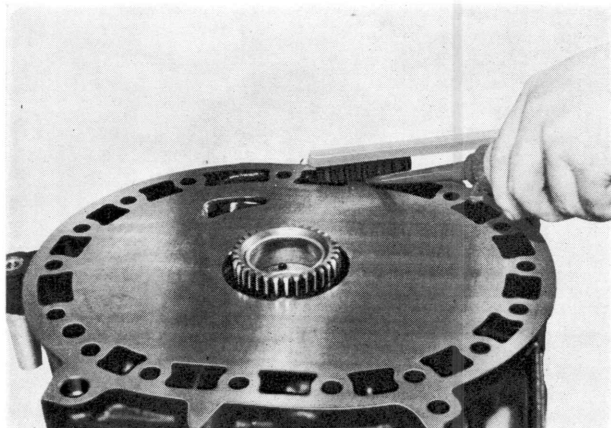

Fig. 1-34 Cleaning front housing

26. Extract the tubular dowels from the intermediate housing with the **dowel puller** (49 0813 215).

27. Remove the intermediate housing. Due to the eccentricity of the shaft at the journal portion, the intermediate housing must be removed by sliding it beyond the journal portion of the front rotor while holding the intermediate housing up and at the same time pushing up the eccentric shaft.

28. Repeat the above procedure to remove the rear rotor housing and the rear rotor assembly.

1-C. ENGINE INSPECTION AND REPAIR

1-C-1. Front Housing

a. Inspection of front housing assembly

1. Check for traces of gas or water leakage.
2. Check for wear and damage on the surfaces contacting each seal.
3. Check for wear, cracks or broken teeth on the stationary gear.
4. Check for wear, scratching, flaking, and other damage to the main bearing.

b. Cleaning the front housing

It is recommended that the following steps are taken to remove carbon and sealing agent from the front housing.

1) Carbon Deposits

Use an extra-fine emery paper. When a carbon scraper is to be used, be careful not to damage the matching surfaces of the housing.

2) Sealing Agent

Use a cloth or a brush soaked in a solution of ketone or thinner.

c. Inspection of front housing for distortion

Place a straight edge on the housing surface as shown in Fig. 1-35, and measure the clearance between both with a feeler gauge.

The housing must be replaced if the distortion is found to be more than 0.04 mm. (0.002 in.).

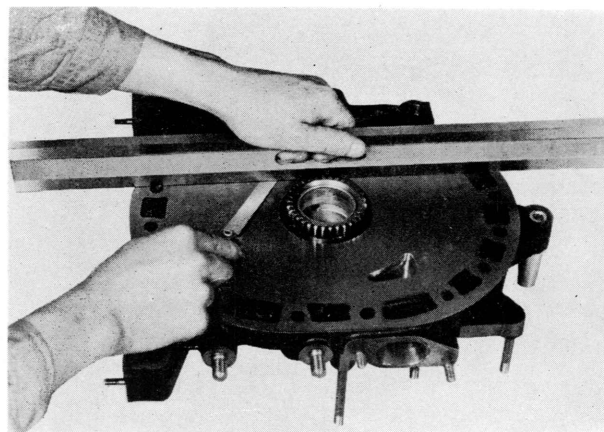

Fig. 1-35 Checking front housing distortion

d. Inspection of front housing for wear

Wear of the matching surfaces of the front housing and the rotor should be measured with a dial indicator. The front housing must be replaced if the wear exceeds 0.1 mm. (0.004 in.).

There is a tendency of increased wear at both ends of the minor axis of the front housing. The effective width of this wear is small.

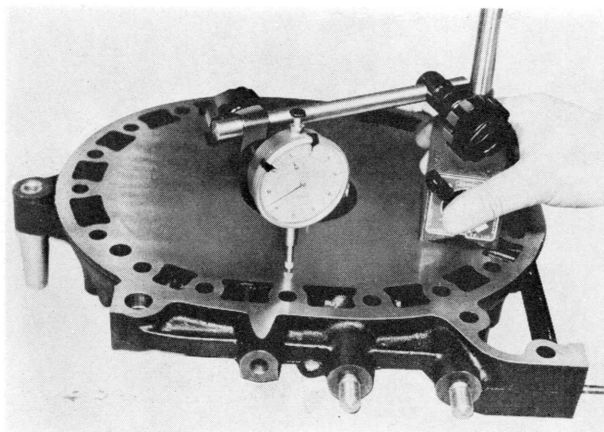

Fig. 1-36 Checking front housing wear

e. Checking the main bearing clearance

The main bearing clearance is measured by checking the inner diameter of the main bearing and the outer diameter of the journal section of the eccentric shaft. The standard main bearing clearance is 0.04~0.06 mm. (0.0016~0.0024 in.), and the bearing must be replaced if the clearance becomes more than 0.1 mm. (0.0039 in.).

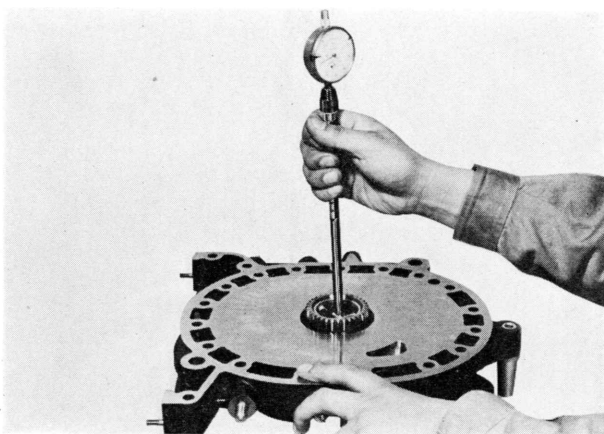

Fig. 1-37 Measuring main bearing inner diameter

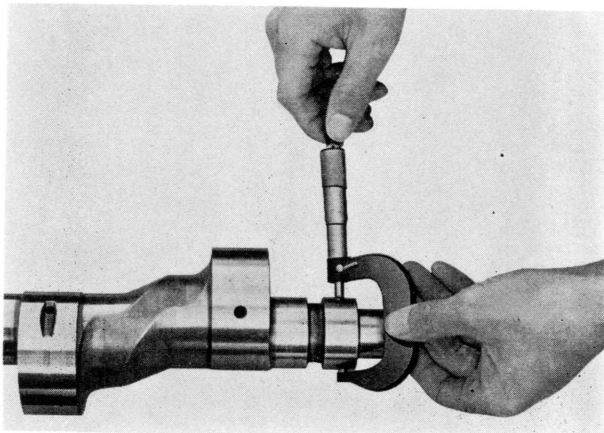

Fig. 1-38 Measuring main journal diameter

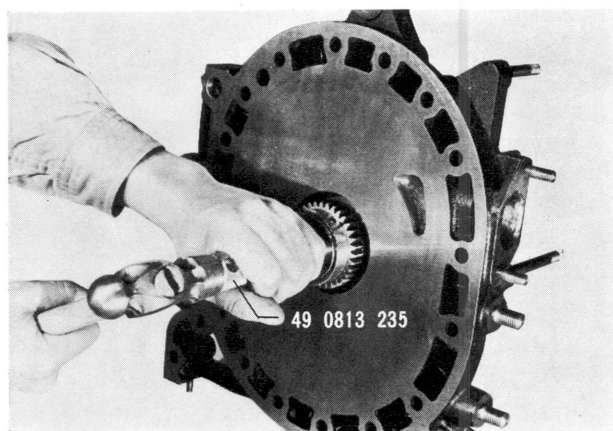

Fig. 1-39 Removing stationary gear

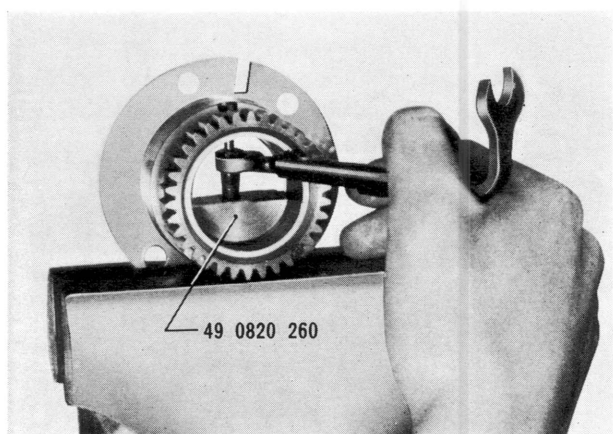

Fig. 1-40 Removing lock pin

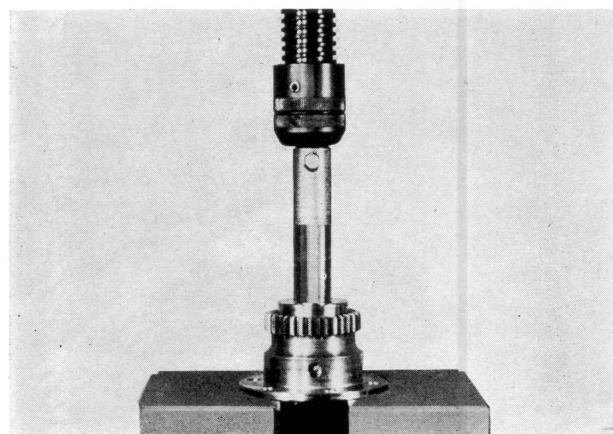

Fig. 1-41 Removing main bearing

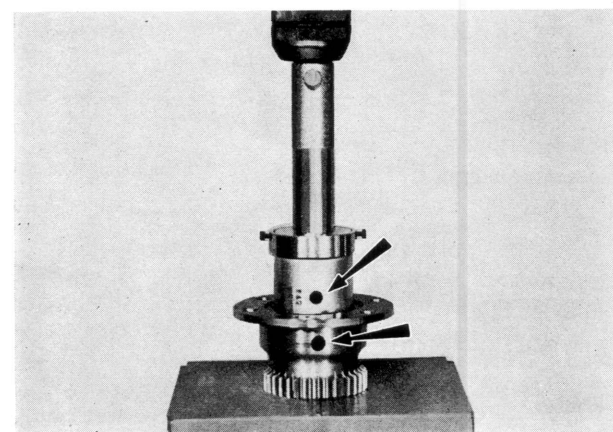

Fig. 1-42 Installing main bearing

f. Removing and assembling the stationary gear and main bearing

When this work is required, proceed in the following steps.

1. Remove the bolts securing the stationary gear to the housing.

2. Press out the stationary gear with the **main bearing puller and installer** (49 0813 235).

3. Mount the stationary gear on a vise. Remove the bearing lock pin by using the **lock pin remover** (49 0820 260).

4. Remove the adapter from the **main bearing puller and installer** (49 0813 235) and use it to extract the main bearing.

5. Attach the adapter on the main bearing puller and installer and use it to press the bearing into the gear until the adapter touches the gear flange. **Be sure to match the oil holes** of bearing and gear, as shown in Fig. 1-42.

6. Insert the lock pin to prevent the bearing from turning.

7. Install the stationary gear to the housing, aligning the slot of the stationary gear flange and the dowel pin, as shown in Fig. 1-43.

8. Tighten the stationary gear attaching bolts.

Note: When replacing the stationary gear, refer to Par. 1-C-5, i.

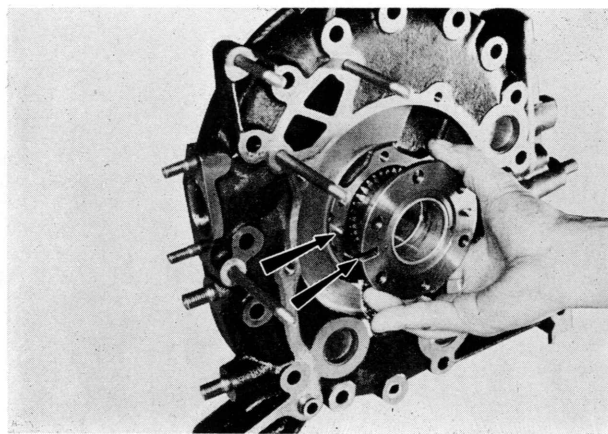

Fig. 1-43 Installing stationary gear

1-C-2. Intermediate Housing

Inspection for distortion or wear of the intermediate housing should be carried out in the same way as described for the front housing. Refer to Par. 1-C-1.

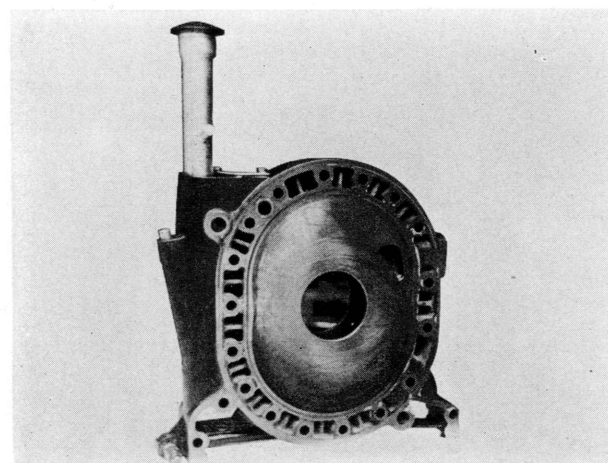

Fig. 1-44 Intermediate housing

1-C-3. Rear Housing

Inspection of the rear housing is carried out according to Par. 1-C-1, but the following point must be inspected as well.

a. Checking the oil seal

Check for wear and damage. If traces of oil leakage are found, replace the oil seal.

b. Replacing the stationary gear

1. Remove the bolts attaching the stationary gear to the rear housing.

2. Using the **main bearing puller and installer** (49 0813 235), extract the stationary gear.

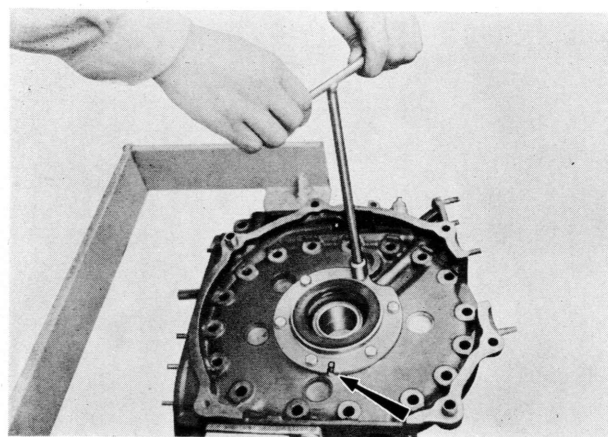

Fig. 1-45 Removing stationary gear

3. Put a thin film of grease on the "O" ring and place it in the groove of the stationary gear.

4. Apply sealing agent to the stationary gear flange.

5. Install the stationary gear on the rear housing while being careful not to damage the "O" ring and to match the slot of the stationary gear flange with the dowel pin of the rear housing.

Note: After the stationary gear is installed, make sure that the oil hole of the stationary gear, which returns the lubricating oil for the main bearing to the oil pan, is facing downward.

6. Tighten the stationary gear attaching bolts.

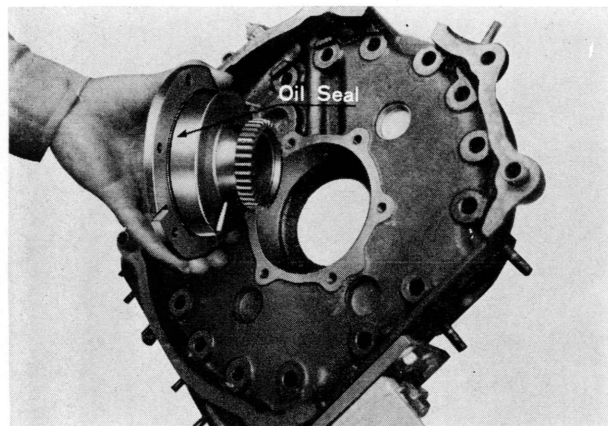

Fig. 1-46 Installing stationary gear

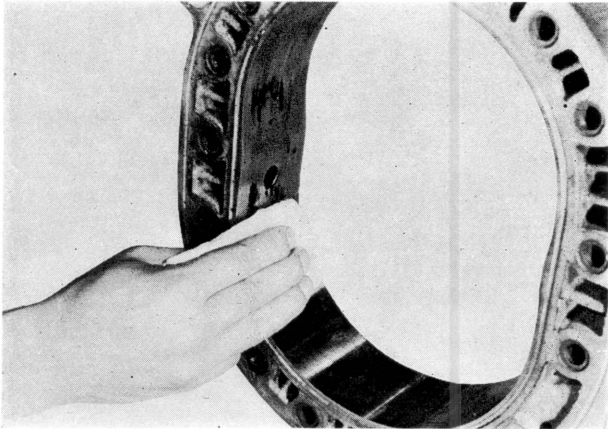

Fig. 1-47 Cleaning rotor housing

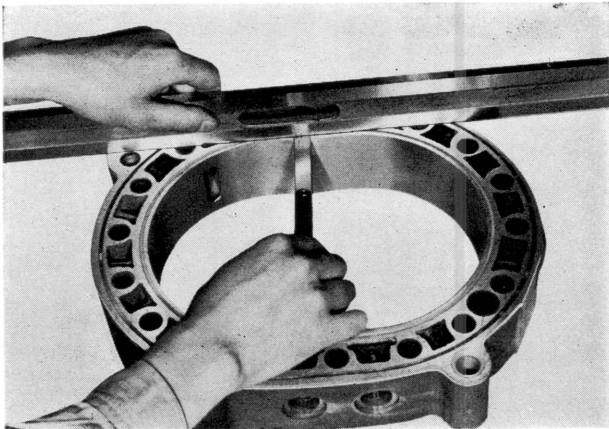

Fig. 1-48 Inspecting rotor housing distortion

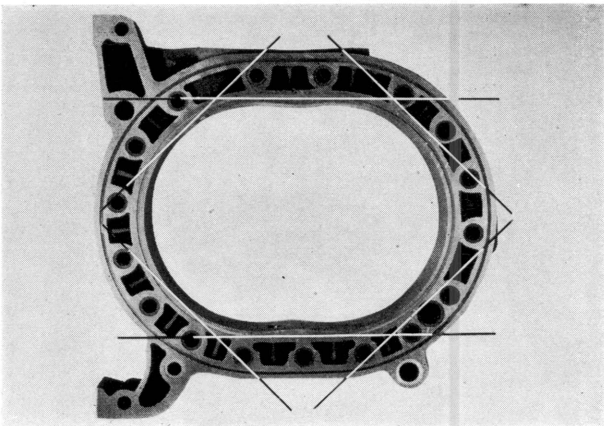

Fig. 1-49 Inspecting positions

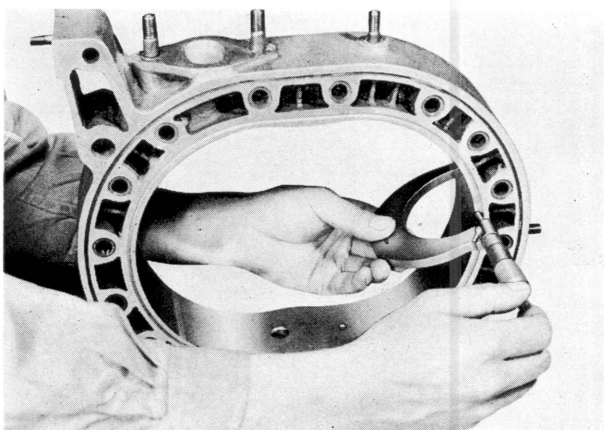

Fig. 1-50 Measuring rotor housing width

1-C-4. Rotor Housing

a. Checking the rotor housing

1. Check for exfoliation, damage or cracks on the chromium-plated surface. If any of these conditions is found, replace the rotor housing.
2. Check for traces of gas or water leakage along the inner margin of each side face of the rotor housing.

b. Cleaning the rotor housing

1. Remove the sealing agent by wiping with a cloth or brush soaked in a solution of ketone or thinner.
2. Remove carbon from the inner surface of the rotor housing by wiping with cloth. Soak the cloth in a solution of ketone or thinner when it is difficult to remove.
3. Remove deposits and rust from the cooling water passages.

c. Inspection of rotor housing distortion

Note: This operation should be done when the trouble such as overheating etc, has been occurred on engine.

Measure the distortion of the rotor housing surface at the position shown in Fig. 1-49, by using a straight edge and a feeler gauge. Replace the part with a new one if the distortion is found to be more than 0.04 mm. (0.002 in.).

d. Measuring the rotor housing width

Note: This operation should be done when the trouble, such as overheating etc, has been occurred on engine.

Measure the width of the rotor housing at points close to the trochoid surface by using a micrometer. Measurements must be taken at least 8 points. If the difference between the maximum value and the minimum value exceeds 0.08 mm. (0.0031 in.), the rotor housing must be replaced with a new one, as there is a possibility of gas or water leakage. The standard width of the rotor is $60 \begin{matrix} +0 \\ -0.02 \end{matrix}$ mm. ($2.3622 \begin{matrix} +0 \\ -0.0008 \end{matrix}$ in.).

1-C-5. Rotor

a. Inspection of combustion condition and gas leakage

1. The combustion condition can, to a certain extent, be judged as in the case of reciprocating engines by the color and quantity of carbon on the rotor. Combustion can be said to be good if the color of carbon is brown. Generally carbon on the front side seen from the direction of rotation is brown, while the rear side tends to show black color. It should be noted that this color varies according to operating conditions just before the engine is dismantled.

2. Gas leakage can be judged by checking the color of the rotor side surface for blow-by traces originating from the side seals and corner seals.

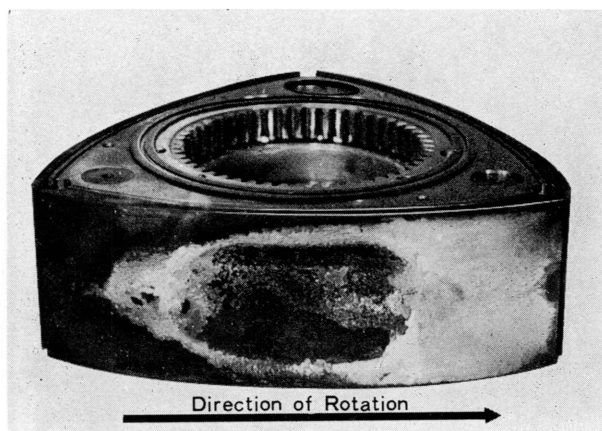

Fig. 1-51 Combustion condition

b. Oil seal inspection

Check for wear and damage of the oil seal lip.

Note: Replace the "O" ring when overhauling the engine.

Check the oil seal protrusion shown in Fig. 1-52. It should be more than 0.5 mm. (0.020 in).

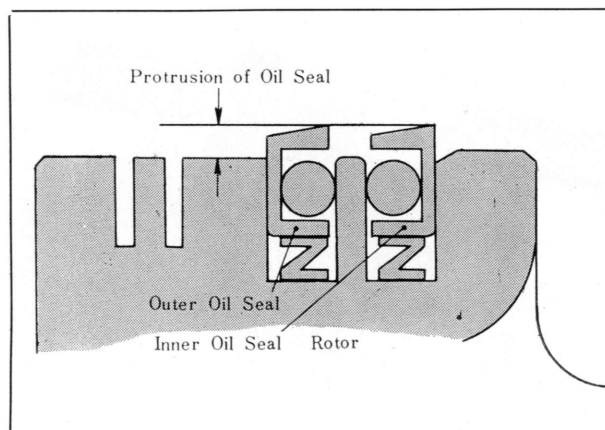

Fig. 1-52 Protrusion of oil seal

c. Replacing the oil seals

1. Remove the oil seal by inserting the **oil seal remover** (49 0813 225) or a screwdriver in the slots of the rotor and prying it off.

Note:

1. Do not exert strong pressure at only one place to prevent deformation of the oil seal.
2. Be careful not to damage the lip of the oil seal.

2. Install the oil seal, referring to Par. 1-D-1.

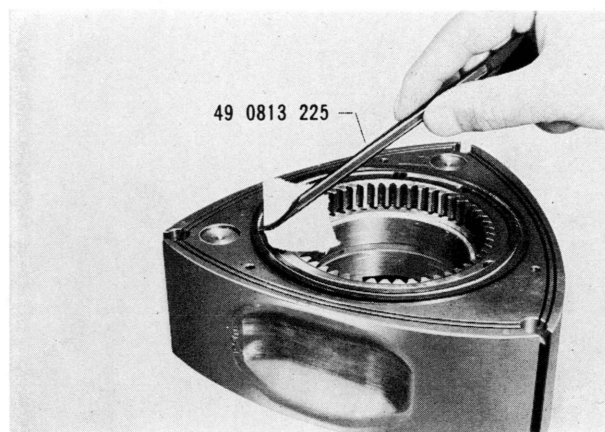

Fig. 1-53 Removing oil seals

d. Cleaning the rotor

Remove the carbon on the rotor by using a carbon remover or emery paper. Carbon in the grooves must be removed with a carbon remover taking care not to damage the grooves. Wash the rotor in cleaning solution and dry by blowing with compressed air.

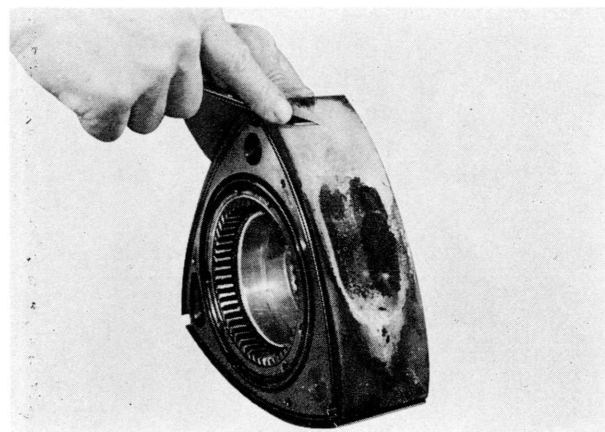

Fig. 1-54 Cleaning rotor

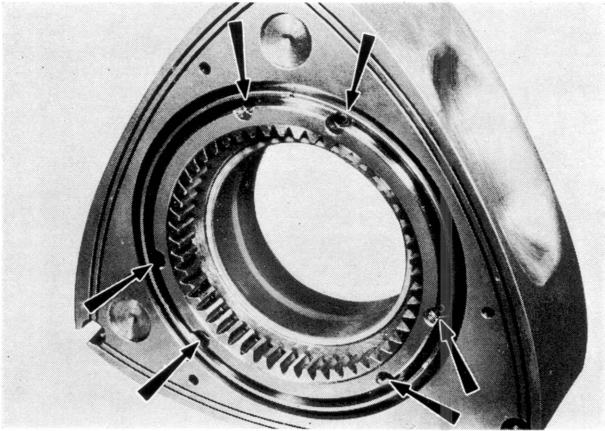

Fig. 1-55 Internal gear fixing positions

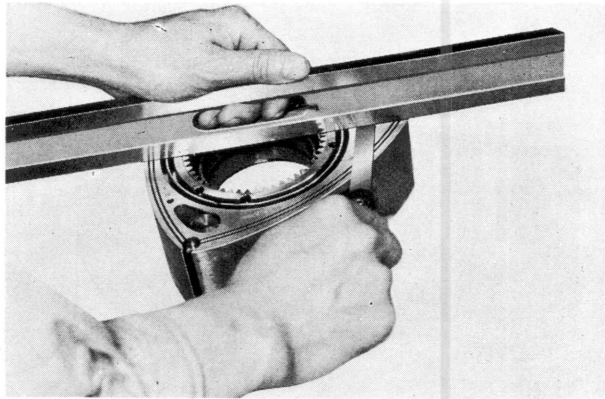

Fig. 1-56 Inspecting land protrusion

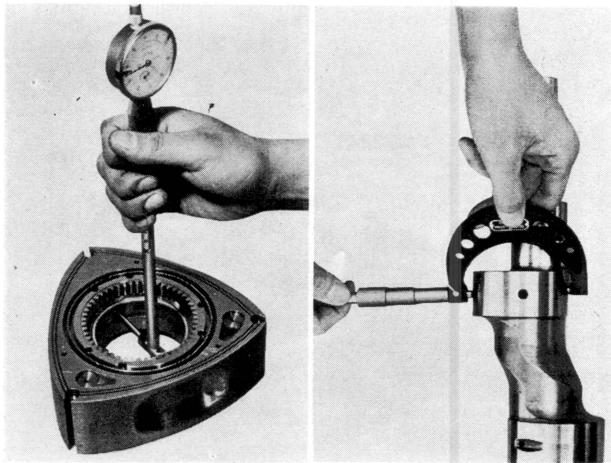

Fig. 1-57 Inspecting bearing clearance

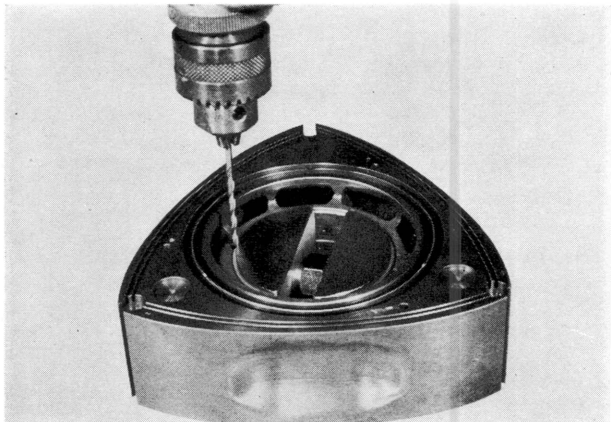

Fig. 1-58 Drilling hole

e. Rotor inspection

Check the rotor for wear and damage. Check the internal gear for cracks, worn or chipped teeth.

The internal gear is fixed on the rotor with 6 double spring pins. Check whether the internal gear is fixed securely on the rotor.

Replace the rotor and gear assembly if the internal gear is found to be loose.

f. Inspecting the land protrusion

Check the land protrusion of the rotor by placing a straight edge over the land and measuring the clearance between the rotor and straight edge with a feeler gauge. It should be **0.10~0.15 mm (0.004~0.006 in.)**. If it is less than specification, there is a possibility of the rotor touching the side housing at places other than the land, causing wear or damage.

g. Inspecting the rotor bearing

Check for wear, flaking or scratches on the bearing. If any of these conditions is found, replace the bearing.

The bearing clearance can be measured by taking the inner diameter of the rotor bearing and the outer diameter of the eccentric shaft journal. The standard clearance is 0.04~0.08 mm. (0.0016~0.0031 in.). Replace the bearing if it is **more than 0.1 mm. (0.0039 in.)**.

h. Replacing the rotor bearing

1. Drill a hole of 3.5 mm. (0.14 in.) diameter and about 7 mm. (0.28 in.) deep in the locking screws which hold the bearing on the rotor.

2. Place the rotor on the support with the internal gear facing upward. Using the rotor bearing puller and installer (49 0813 240) with its adapter ring removed, press out the bearing, being careful not to damage the internal gear.
3. If the bore in the rotor is damaged while removing the bearing, finish the bore with emery paper and blow with compressed air.

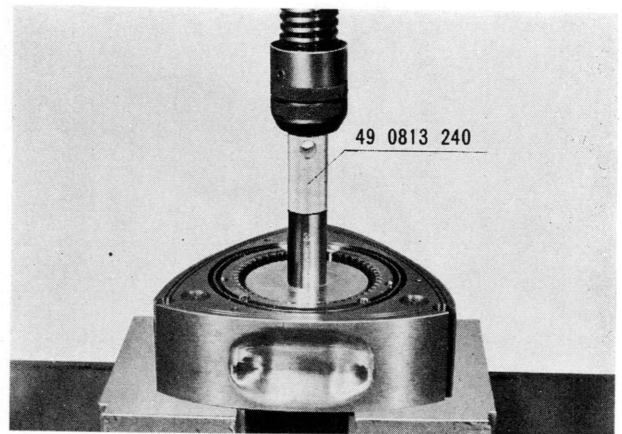

Fig. 1-59 Removing rotor bearing

4. Place the rotor on the support with the internal gear upward. Press fit a new bearing until the oil hole of the bearing matches the oil hole on the apex side of the rotor and the bearing and the boss become flush.

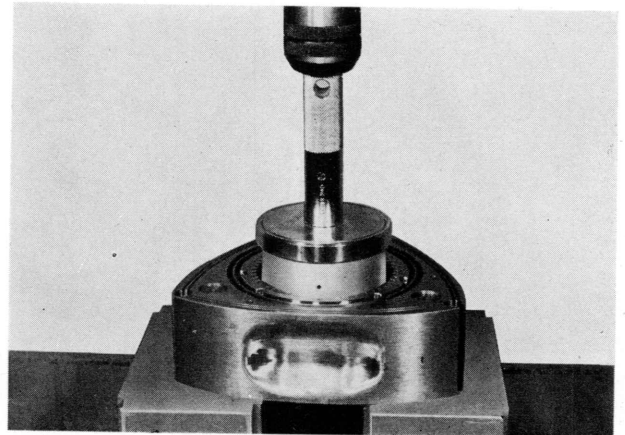

Fig. 1-60 Installing rotor bearing

5. To prevent deformation of the bearing when drilling a new hole, insert the expander (49 0813 245) into the bearing.

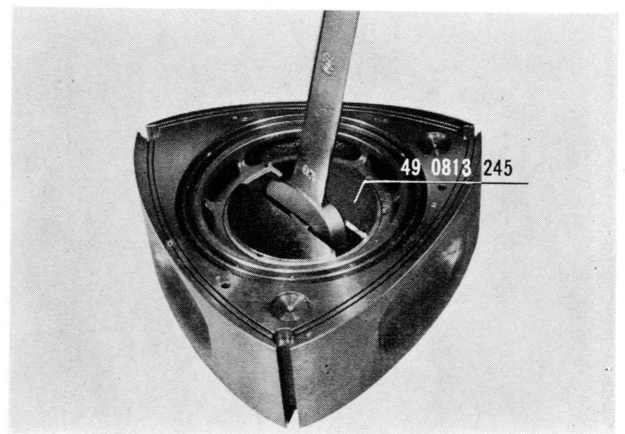

Fig. 1-61 Fitting expander

6. Drill a 3.5 mm (0.14 in) hole of about 7 mm. (0.28 in.) deep at approximately 7 mm. (0.28 in.) to the left or right from the original location of the locking screw hole. The center of the hole must be 0.5 mm. (0.02 in.) from the rotor bore.
7. Thread the hole with an M4, P=0.70 mm tap.

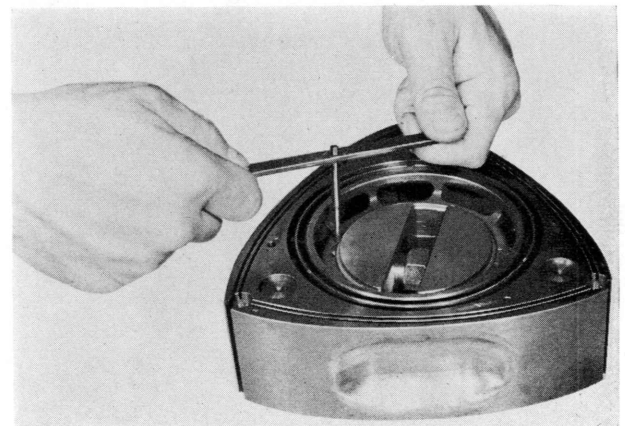

Fig. 1-62 Threading

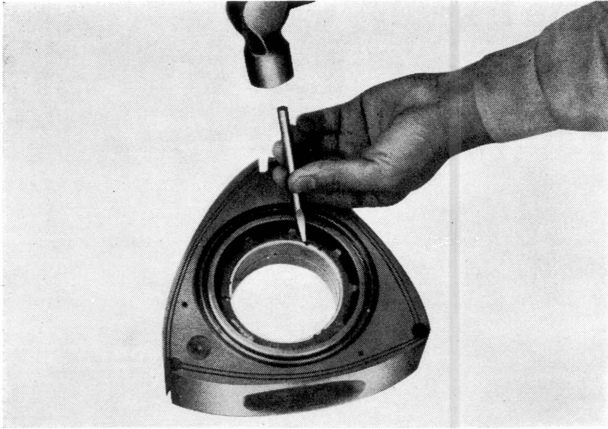

Fig. 1-63 Staking locking screws

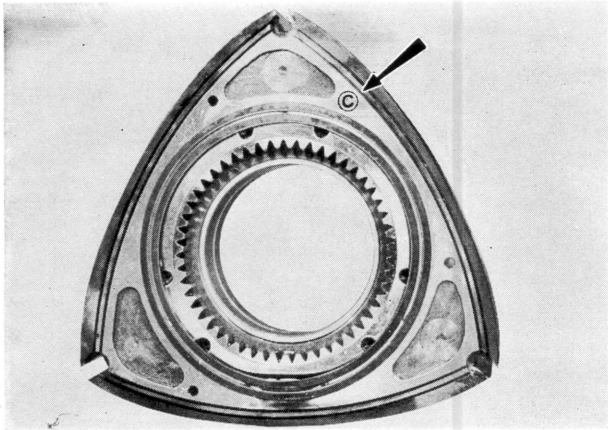

Fig. 1-64 Weight mark of rotor

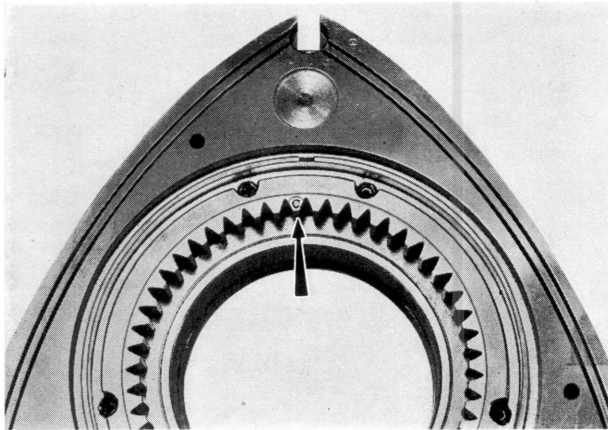

Fig. 1-65 Mark of internal gear

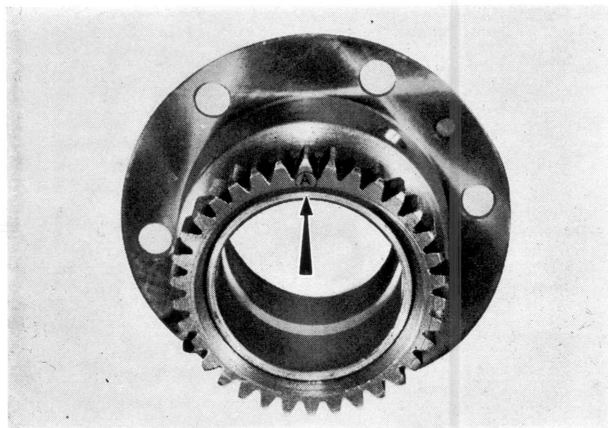

Fig. 1-66 Mark of stationary gear

8. Tighten the locking screw and stake the locking screws into positions with a punch to prevent them from working out.

9. Wash the rotor thoroughly and blow with compressed air.

i. Replacing the rotor

When replacing the rotor, note the following points.

1) Weight of rotor

Rotors are classified into 5 categories according to weight and marked a, b, c, d and e on the internal gear side.

In order to balance the front and rear rotors, the following combinations are adopted in the factory:

Combination of Markings

- a—b
- b—a, b, c
- c—b, c, d
- d—c, d, e
- e—d

Note: If it is necessary to replace a rotor, use a rotor marked with "c" in any case.

2) Internal and stationary gear backlash

The internal gears and stationary gears are classified into 3 categories, which are shown by embossing markings, A, no mark and C.

In order to obtain a proper backlash between the internal gear and the stationary gear, the identically-marked gears are incorporated in the factory.

Note: When replacing a stationary gear at dealer, use a unmarked stationary gear in any case.

1-C-6. Seals and Springs

a. Cleaning the seals and springs

1) Apex Seal

Use a carbon remover to remove the carbon from both sides while being careful not to damage the apex seal. Wash with cleaning solution.

Note: A special carbon material is used for the apex seal. This is weaker and easier to damage than metal. Therefore, take extra care. Never use emery paper as it will damage the apex seal.

2) Corner Seal and Side Seal

Clean with carbon remover and wash. Never use emery paper.

3) Seal Spring

Remove carbon with the carbon remover and wash in cleaning solution.

b. Inspecting the apex seals

Check apex seals for wear, damage or cracks and replace if any of these conditions is found.

Measure the height of the apex seal with a micrometer. Replace if the height is **less than 8.0 mm. (0.3150 in.)**.

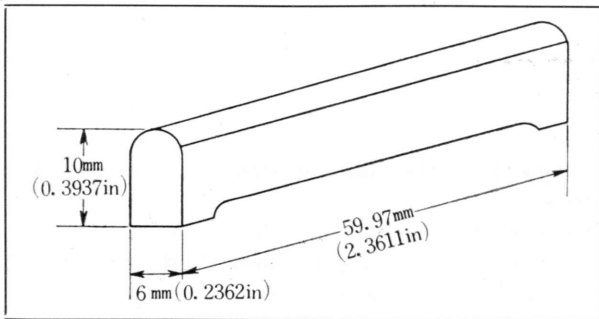

c. Inspecting the gap between apex seal and groove

To measure the gap between apex seal and groove, place the apex seal in its respective rotor groove and use a feeler gauge to measure the gap. As shown in Fig. 1-70, the apex seal tends to wear unevenly and for this reason the feeler gauge should be inserted fully into the bottom of the groove. The standard value of this gap is 0.036 ~ 0.072 mm. (0.0014 ~ 0.0028 in.) and the apex seal must be replaced if the gap is **more than 0.1 mm. (0.004 in.)**.

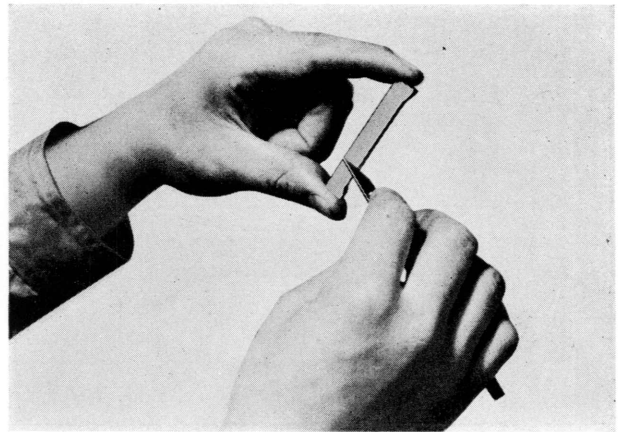

Fig. 1-67 Cleaning apex seal

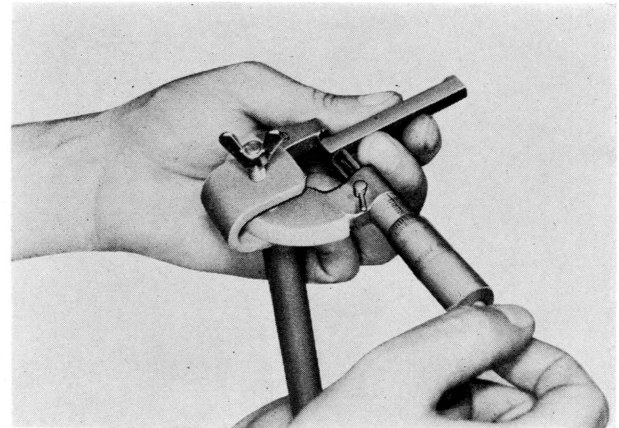

Fig. 1-68 Measuring apex seal height

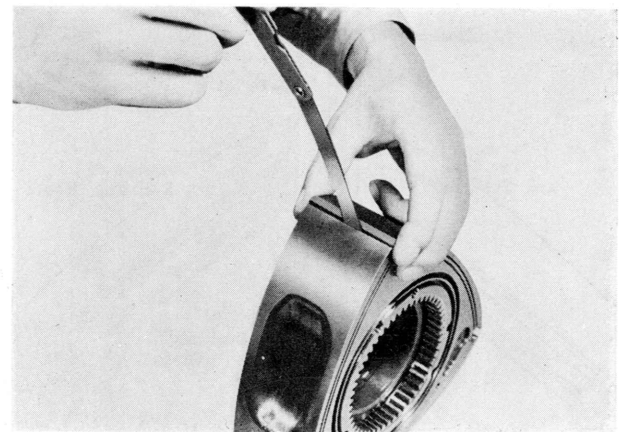

Fig. 1-69 Checking gap of apex seal and groove

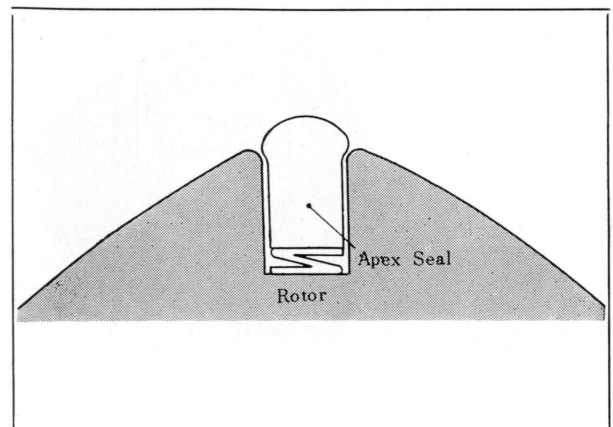

Fig. 1-70 Wear of apex seal

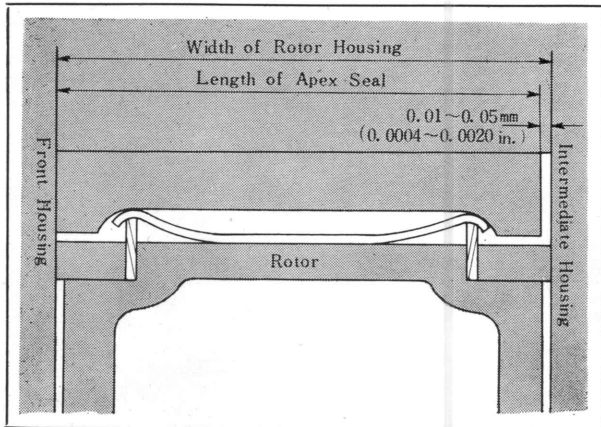

Fig. 1-71 Gap between apex seal and side housing



Fig. 1-72 Checking side seal gap

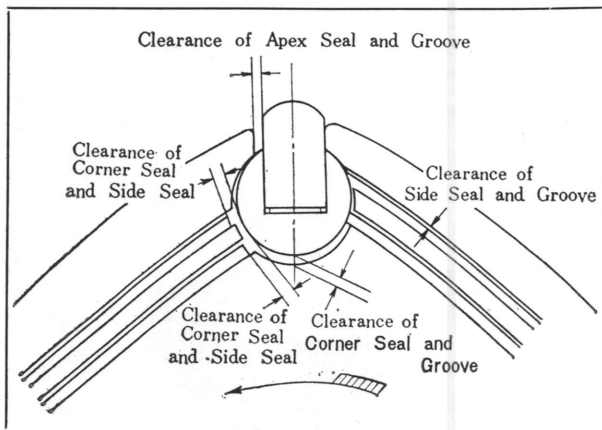

Fig. 1-73

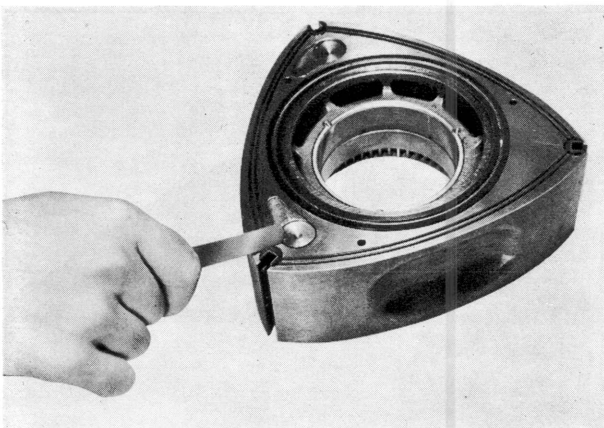

Fig. 1-74 Checking corner seal gap

d. Inspecting the gap between apex seal and side housing

Measure the length of the apex seal with a micrometer. Compare this measurement with the minimum value of the rotor housing width (Refer to Par. 1-C-4.) to calculate the gap between the apex seal and side housing. The normal value of this gap is 0.01~0.05 mm. (0.0004~0.0020 in.), and the apex seal must be replaced if it is **more than 0.15 mm. (0.0059 in.)**.

e. Inspecting the gap between side seal and groove

Measure the gap with a feeler gauge. The standard clearance is 0.04~0.07 mm. (0.0016~0.0028 in.), and the side seal must be replaced if it **exceeds 0.1 mm. (0.004 in.)**.

f. Inspecting the gap between corner seal and groove

The standard clearance is 0.032~0.061 mm. (0.0013~0.0024 in.). If the gap **exceeds 0.08 mm. (0.003 in.)**, the seal must be replaced.

g. Inspecting the gap between side seal and corner seal

Check the gap with the side seal and corner seal installed on the rotor. Insert a feeler gauge between the rear of the side seal (against the turning direction of rotor) and the corner seal. When this clearance is too large, gas-sealing performance becomes poor, while if it is too small, free movement is impaired as the result of heat-expansion during operation, causing extensive wear of the side housing.

The side seal must be replaced if the gap between the side seal and the corner seal **exceeds 0.4 mm. (0.016 in.)**.

When a side seal is replaced, check whether the gap is **more than 0.13 mm. (0.0051 in.)**. If it is less than

0.13 mm. (0.0051 in.), grind the end of the side seal with the fine file.

Note: Be sure to use the right one when installing a new side seal as there are 4 different types, namely, the front inner, front outer, rear inner, and the rear outer seal.

h. Replacing the corner seal

According to the direction and extent of difference between the center of the apex seal groove and the center of the corner seal, the mark of K, P, Q or T is inscribed on the corner seal as well as on the rotor, as shown in Fig. 1-76.

The identically-marked corner seal and rotor are incorporated in the factory.

Note: If it becomes necessary to replace a corner seal, use the corner seal marked only P or T as combined as the following chart.

Rotor mark	Corner seal mark
K, P	P
Q, T	T

i. Inspecting the seal springs

Measure the free height of each spring as shown in Fig. 1-77. Replace the spring if the free height is less than the limit mentioned in the following table.

	Standard height	Limit
Apex seal spring	5.0 mm. (0.197 in.)	4.0 mm. (0.158 in.)
Corner seal spring	2.6 mm. (0.102 in.)	1.9 mm. (0.075 in.)
Side seal spring	2.2 mm. (0.087 in.)	1.8 mm. (0.071 in.)

Note: When the corner seal, corner seal spring, side seal and side seal spring are installed onto the rotor, check the protrusion of each seal, referring to Par. 1-D-2.

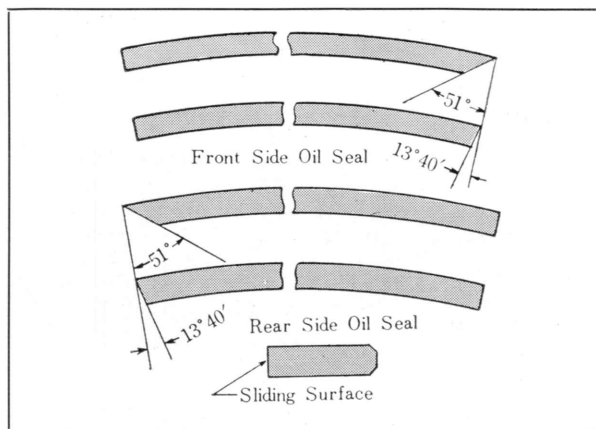

Fig. 1-75 Shape of side seal

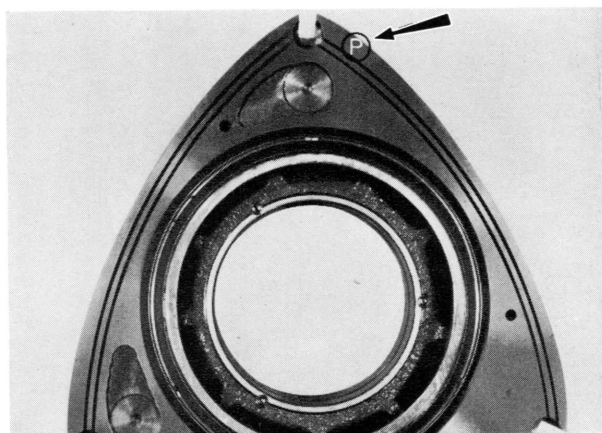

Fig. 1-76 Mark of corner seal groove

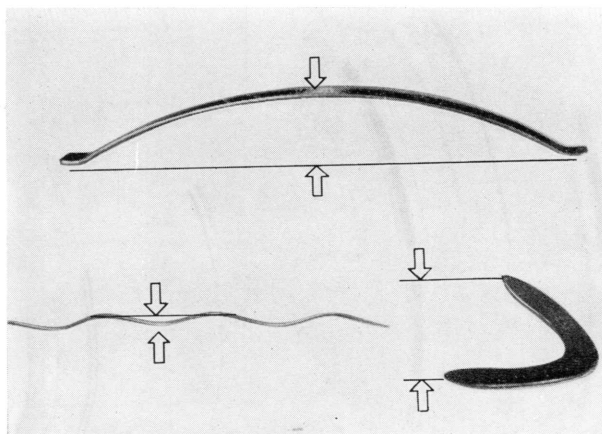

Fig. 1-77 Inspecting spring height

1-C-7. Eccentric Shaft

a. Inspecting the eccentric shaft

Wash the shaft in a cleaning solution and blow the oil passage with compressed air. Check for cracks, scratches, wear or blockage of oil passages.

Measure the diameter of all journals of the eccentric shaft with a micrometer. Replace the shaft if the wear is excessive. The standard diameter of the main journal is 43mm. $\begin{matrix} +0 \\ -0.016 \end{matrix}$ (1.6929 in. $\begin{matrix} +0 \\ -0.0006 \end{matrix}$), while that of the rotor journal is 74 mm. $\begin{matrix} -0.015 \\ -0.030 \end{matrix}$ (2.9134 in. $\begin{matrix} -0.0006 \\ -0.0012 \end{matrix}$).

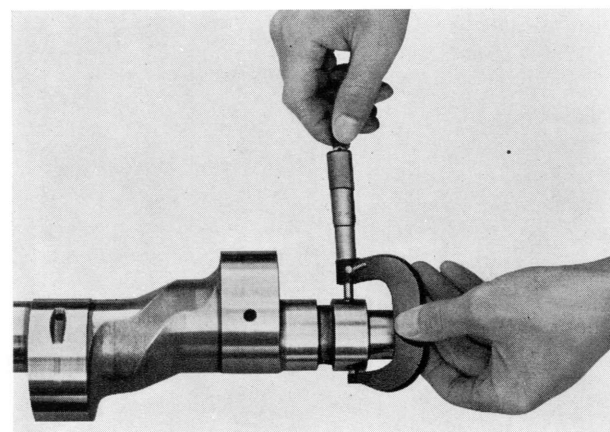

Fig. 1-78 Measuring journal diameter

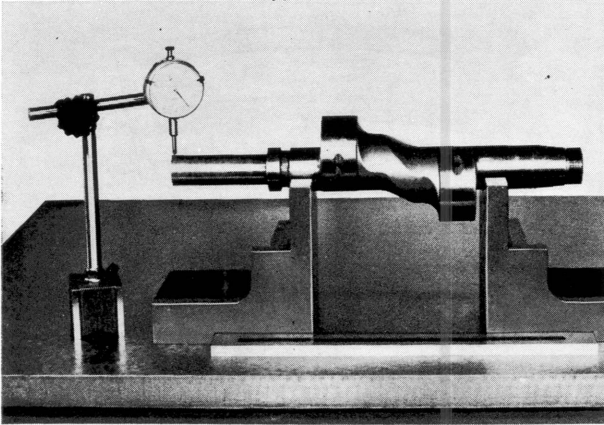

Fig. 1-79 Checking eccentric shaft run-out

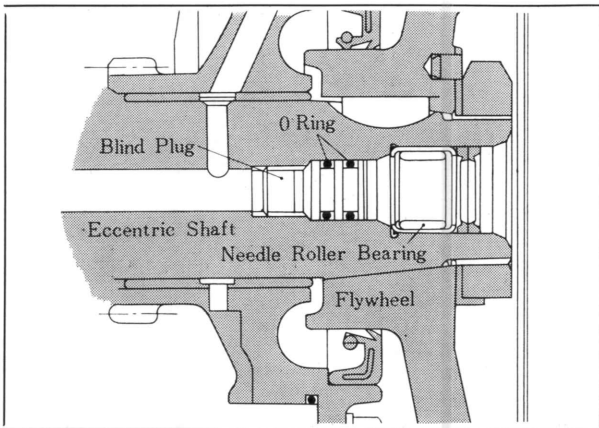

Fig. 1-80 Blind plug

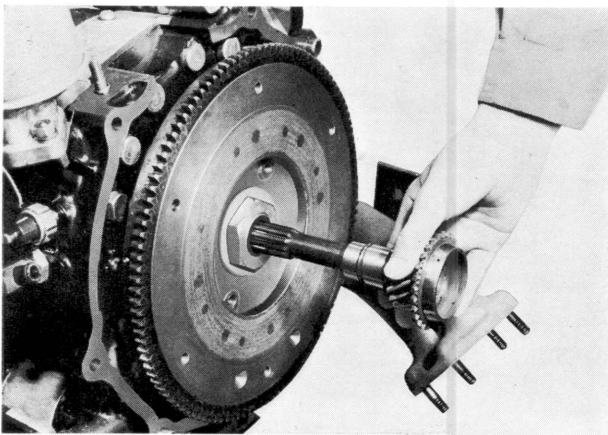

Fig. 1-81 Inspecting needle roller bearing

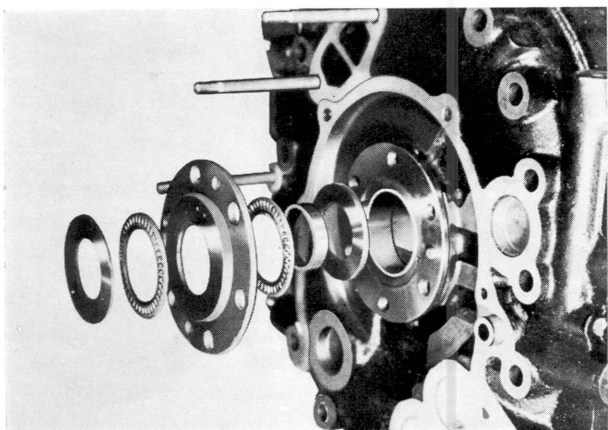

Fig. 1-82 Thrust bearings

b. Checking the eccentric shaft run-out

Mount the eccentric shaft on the "V" blocks. Turn the shaft slowly and measure the deflection at the front and rear with a dial gauge. If the deflection is more than 0.03 mm. (0.0012 in.), replace the shaft with a new one.

c. Inspecting the blind plug

An oil passage is provided inside the eccentric shaft. The rear end is sealed with a blind plug for a pressure of 3~5 kg/cm² (43~71 lb/in²). Therefore, it is important to check for oil leakage or loose plug. If oil leakage is found, remove the blind plug with a hexagonal Allen key and replace the "O" ring.

d. Inspecting the needle roller bearing

Check for wear or damage to the needle roller bearing at the rear end of the eccentric shaft. Then insert the pilot part of the main drive shaft and check for smooth operation and proper clearance.

e. Inspecting the thrust bearings

The end thrust of the eccentric shaft is taken by the thrust bearings. Check the thrust bearings for wear or damage. Also inspect the bearing housing and thrust plate for wear.

1-D. ENGINE ASSEMBLY

The procedures for assembling the engine when the engine is to be completely overhauled are as follows:

1-D-1. Installing the Oil Seals

To install the oil seals, use the **oil seal installer** (49 0820 220) and proceed as follows:

1. Place the rotor on a rubber pad or cloth to protect it from damage.
2. Fit the outer and inner oil seal springs in their respective grooves of the rotor so that **the end of the spring is upward** as shown in Fig. 1-83 and that **the spring gap is located opposite each other** as shown in Fig. 1-84.
3. After fitting the springs, apply engine oil to the rotor groove.
4. Insert a new "O" ring in each oil seal.

Note: When replacing the oil seal, be sure to confirm smooth movement by placing the oil seal on the rotor groove before installing the "O" ring.

5. Insert the oil seal installer No. 1 in the rotor bearing and place the outer oil seal on the circumference of the oil seal installer.

Note: As chamfering is performed and a red mark is given on the bottom of the oil seal, confirm these before incorporating the oil seal so that the head of the oil seal (lip) may not be mistaken with its bottom.

6. Using the oil seal installer No. 2, insert the outer oil seal carefully into the rotor groove.

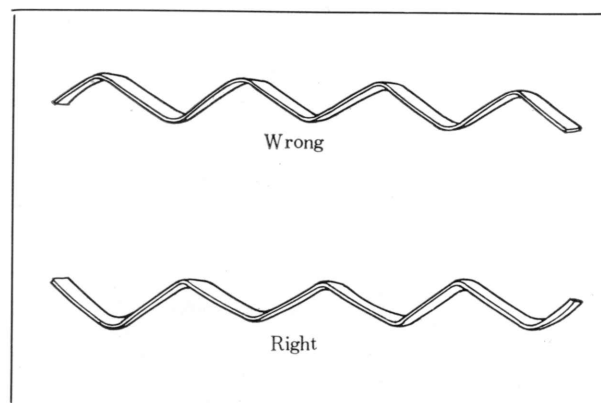

Fig. 1-83 Direction of seal spring

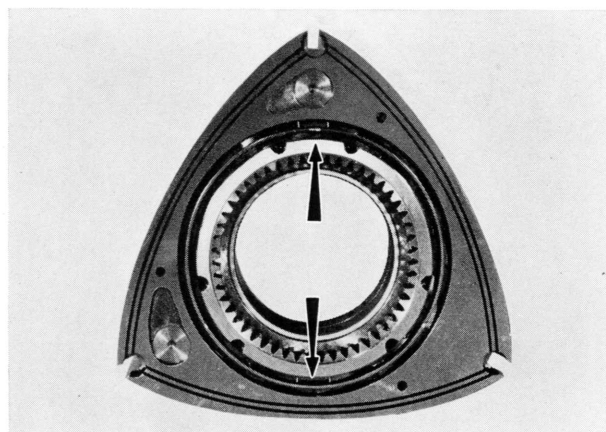

Fig. 1-84 Position of spring gap



Fig. 1-85 Installing outer oil seal

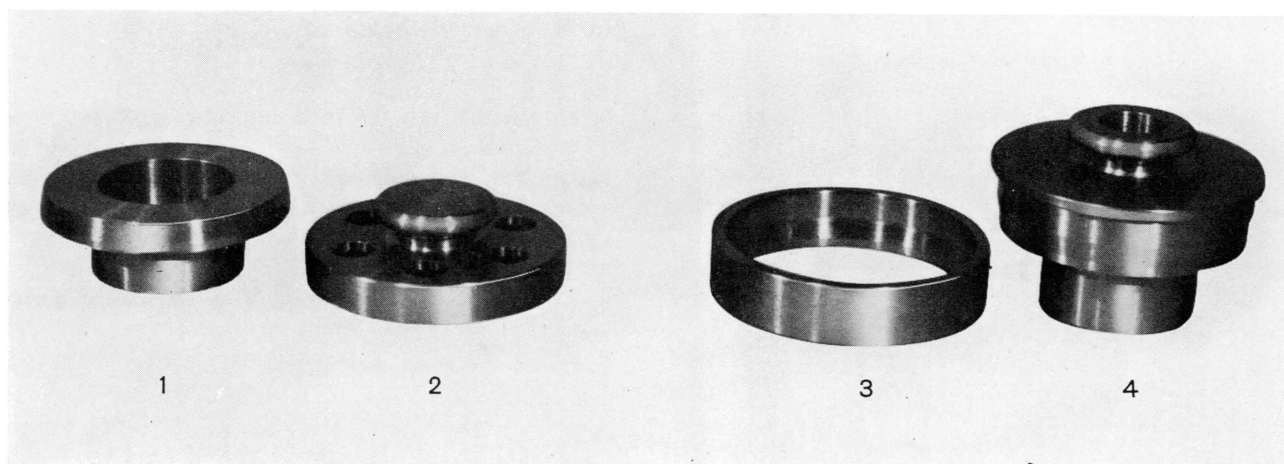

Fig. 1-86 Oil seal installer (49 0820 220)

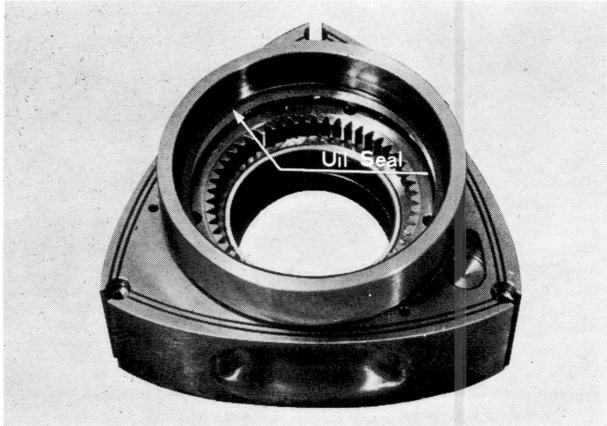

Fig. 1-87 Installing inner oil seal

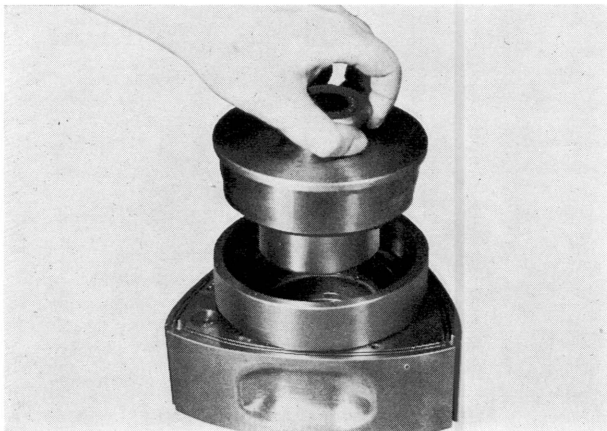

Fig. 1-88 Installing inner oil seal

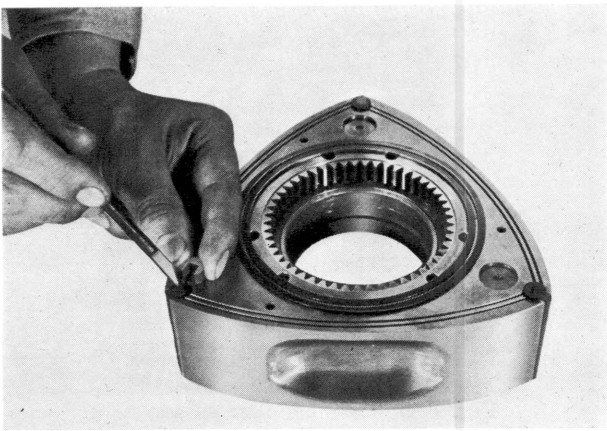

Fig. 1-89 Fitting corner seal

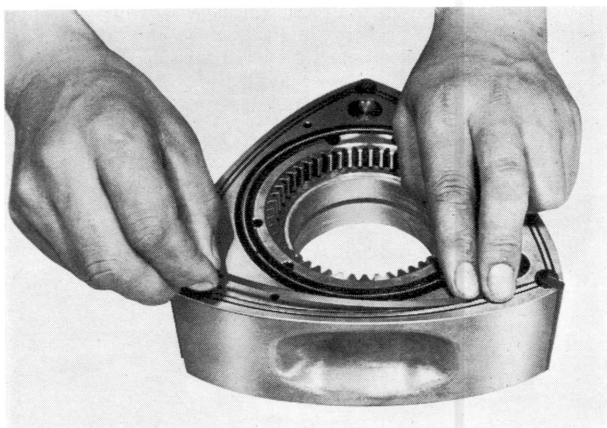

Fig. 1-90 Fitting side seal

7. Put the inner oil seal on the bore of the oil seal installer No. 3 and press it in until the lower edge of the oil seal and that of the installer are flush.

8. Place the installer No. 3, with the inner oil seal attached, on the rotor with the oil seal facing the groove.

9. Press the oil seal into the groove with the installer No. 4.

Note: Be sure to confirm that the "O" ring in the rotor is not damaged and well inside the groove. Also, check easy movement of the oil seal by moving it manually.

10. Follow the same procedures to install the oil seals to the other side of the rotor.

1-D-2. Installing the Seals

1. Place the rear rotor on a rubber pad or cloth with the internal gear facing upward.

2. Confirming the identification marks of the apex seal, place each apex seal on the rotor groove without the spring.

3. Lubricate the grooves and install the corner seal springs and corner seals.

Note: The corner seal must be 1.3~1.5 mm. (0.05~0.06 in.) longer than the rotor surface. It must also move freely, when pressed by hand.

4. Fit the side seal springs on the rotor **with both ends facing upward**. The spring should be located in the center of the groove.

5. Fit the side seals to their respective grooves.

Note: The side seal must protrude approx. 1.0 mm. (0.04 in.) from the rotor surface. Also check free movement by pressing manually.

6. Apply oil to the internal gear and seals of the rotor.

7. Install the **rotor clamp** (49 0813 230).

1-D-3. Installing the Rear Rotor

1. Mount the rear housing on the **engine stand** (49 0107 680A, 49 0813 005 and 49 0820 006), so that the rotor friction surface of the housing faces upward.
2. Install the rotor on the rear housing so as to mesh the internal gear and stationary gear.

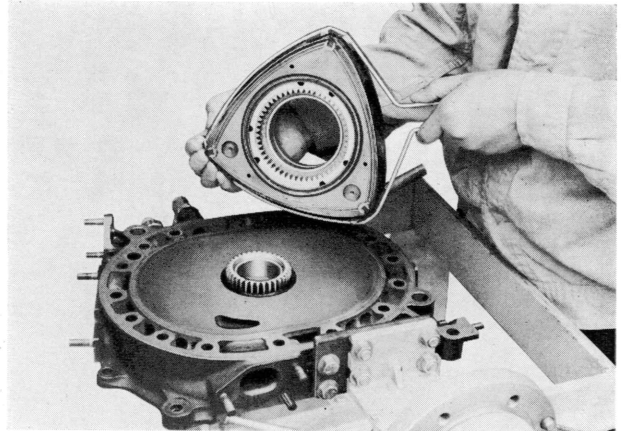

Fig. 1-91 Installing rear rotor assembly

Note: In this case, one of the rotor apices must be set to any one of the four places shown in Fig. 1-92, in order to prevent the corner seal from dropping into the ports.

3. Remove the rotor clamp.

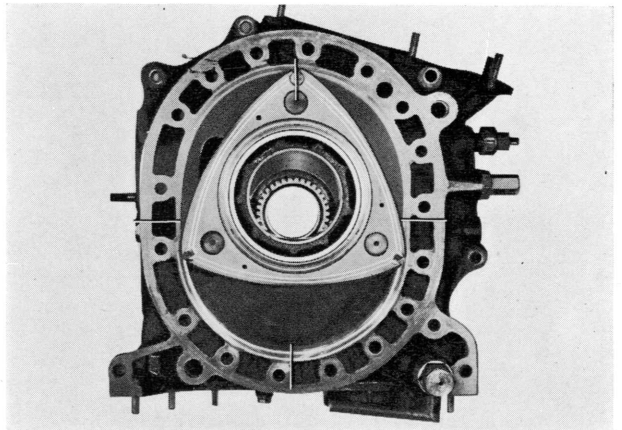

Fig. 1-92 Location of rotor apex

1-D-4. Installing the Rear Rotor Housing

1. Apply sealing agent to the rear side of the rear rotor housing, as shown in Fig. 1-93. Be careful not to let the sealing agent penetrate into the cooling water circuits or oil circuits.

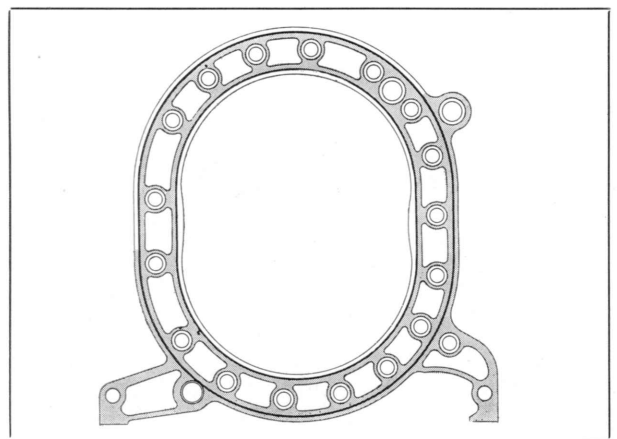

Fig. 1-93 Applying sealing agent

2. Place the "new" "O" rings and sealing rubbers on the rear rotor housing.

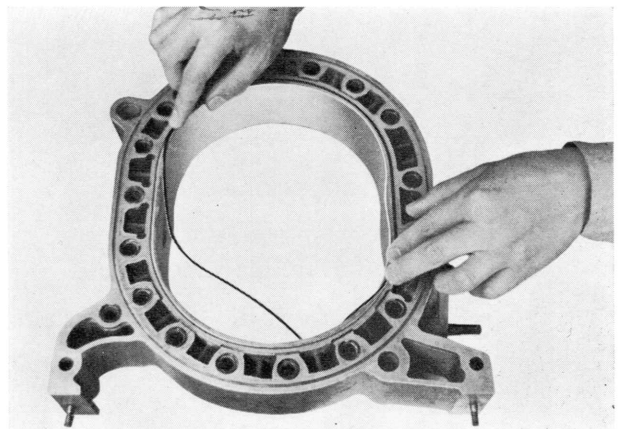

Fig. 1-94 Fitting sealing rubber

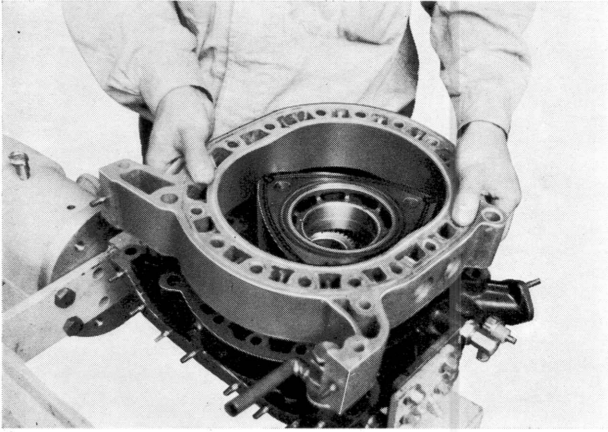

Fig. 1-95 Installing rear rotor housing

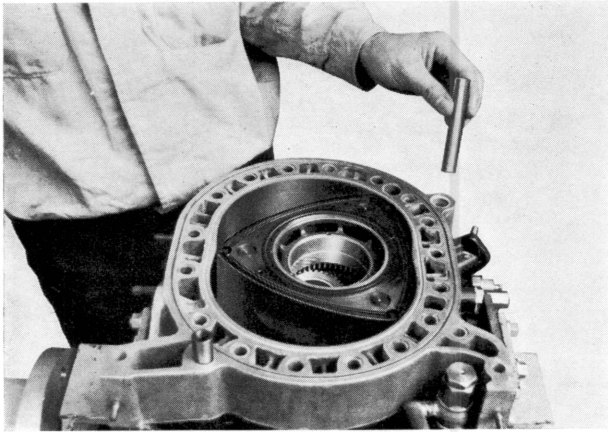

Fig. 1-96 Installing tubular dowels

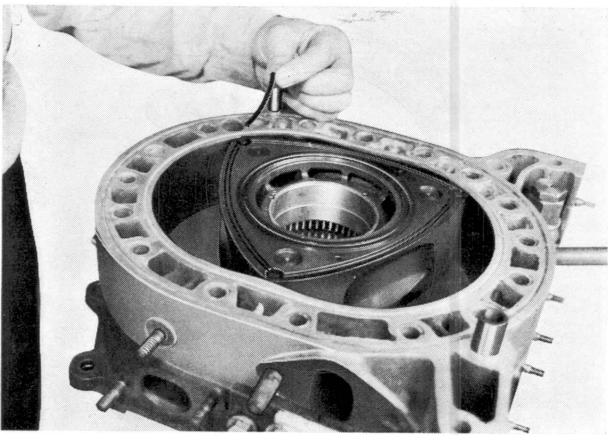

Fig. 1-97 Installing apex seal spring

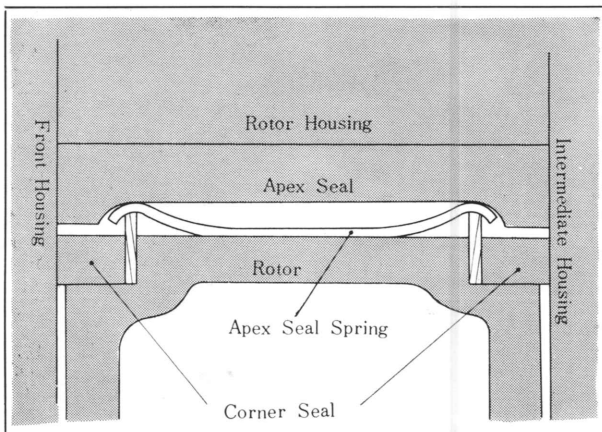

Fig. 1-98 Position of apex seal spring

3. Reverse the rotor housing while taking care not to let the sealing rubbers and "O" rings drop out of the grooves, and mount it on the rear housing.

4. Match the tubular dowel holes of the rear rotor housing and rear housing. Slightly lubricate the tubular dowel and insert it into the hole.

1-D-5. Installing the Seals

1. Install the apex seal spring on the reverse side of the apex seal, as shown in Fig. 1-98.
2. Fit the corner seals and side seals on the rotor. (Refer to step 3 and 4 in Par. 1-D-2.)
3. Apply some oil to the seals, rotor bearing and friction surfaces of the rotor housing.

1-D-6. Installing the Eccentric Shaft

1. Lubricate the journal sections.
2. Insert the eccentric shaft while being careful not to damage rotor bearing and main bearing.

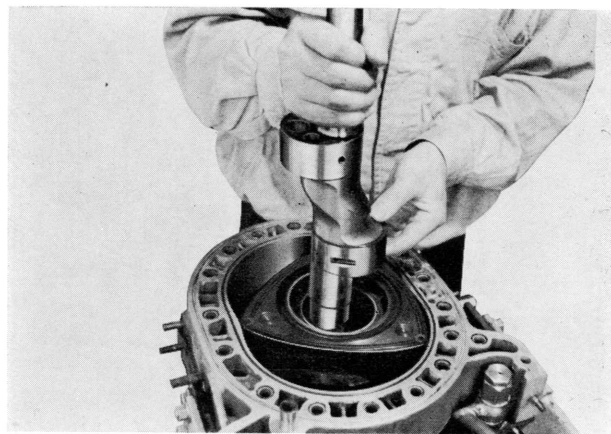

Fig. 1-99 Installing eccentric shaft

1-D-7. Installing the Intermediate Housing

1. Apply sealing agent on the mating surface of the rear rotor housing.
2. Place the new sealing rubbers and "O" rings on the rear rotor housing.
3. Make sure that the rotor housing is free from foreign matter.
4. Move up the eccentric shaft from the reverse side of the rear housing to a point where the journal section does not protrude from the rotor. Then install the intermediate housing over the eccentric shaft.

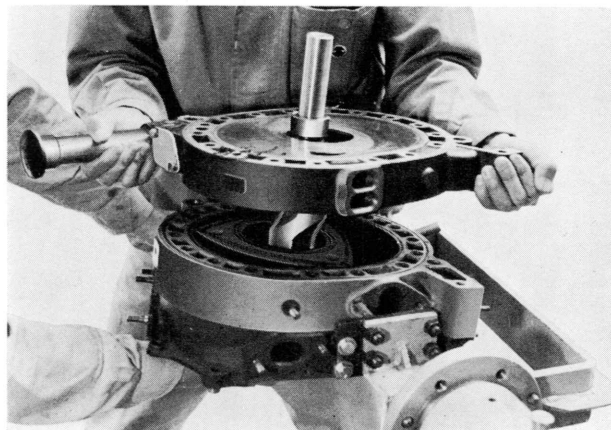

Fig. 1-100 Installing intermediate housing

1-D-8. Installing the Front Rotor and Housing

Refer to Par. 1-D-2, 3, 4 and 5 and assemble the front rotor and front rotor housing.

1-D-9. Installing the Front Housing

1. Oil the stationary gear and main bearing of the front housing.
2. Install the front housing over the eccentric shaft. If necessary, turn the rotor slightly to engage the teeth of the front housing stationary gear and the front rotor internal gear.

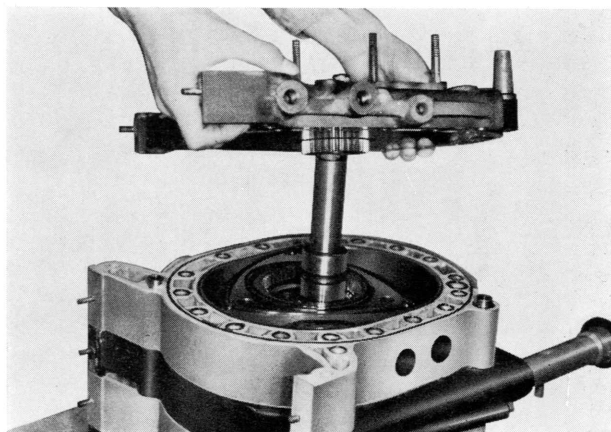

Fig. 1-101 Installing front housing

1-D-10. Tightening the Tension Bolts

1. Install the tension bolts.

Note: There are tension bolts of 4 different lengths. Be sure not to interchange.

2. Tighten the bolts gradually in the order shown in Fig. 1-102. The specified tightening torque is **2.5 m-kg (18 ft-lb)**.

Note: Attach the pulley mounting bolt to the front end of the eccentric shaft and turn by means of a wrench to confirm smooth rotation.

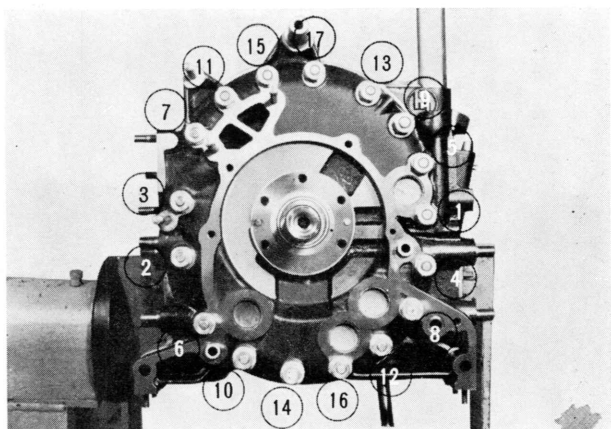

Fig. 1-102 Tightening order

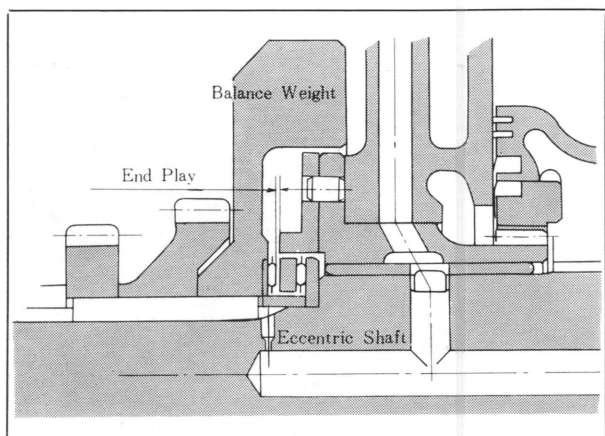

Fig. 1-103 End play of eccentric shaft

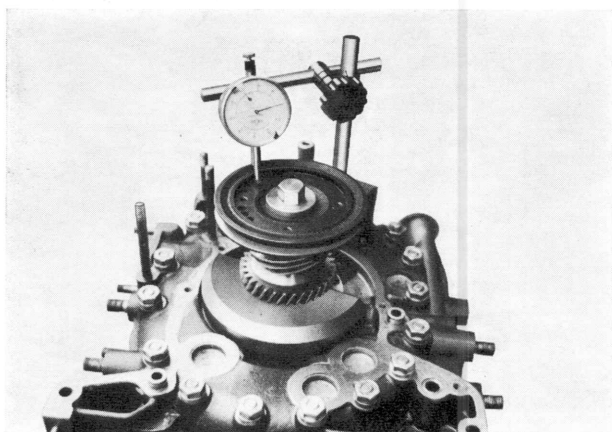

Fig. 1-104 Checking end play

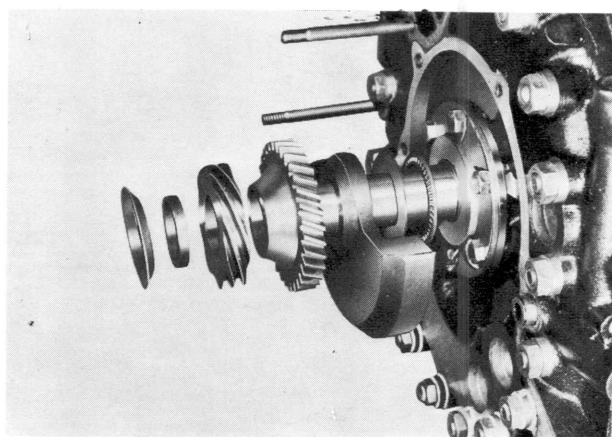

Fig. 1-105

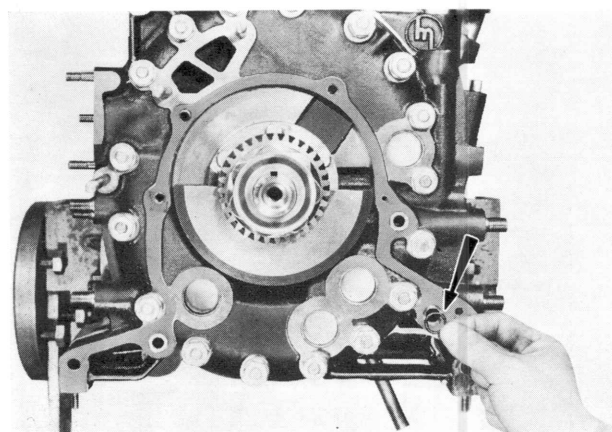

Fig. 1-106 Fitting "O" ring

1-D-11. Adjustment of Eccentric Shaft End Play

1. Install the thrust bearing, thrust washer, balance weight, oil pump drive gear, distributor drive gear and spacer, in that order on the eccentric shaft.

Note: When installing the thrust bearing, center must match the center of the eccentric shaft.

2. Install the eccentric shaft pulley and tighten the bolt.

3. Mount a dial indicator so that the feeler touches the pulley.

4. Move the pulley fore and aft and read the scale of dial indicator. The measured value should be **0.04~0.07 mm. (0.0016~0.0028 in.)**. If it is more than 0.07 mm. (0.0028 in.), replace the spacer. The following three kinds of spacer are available:

Mark	Thickness
N	9.00mm±0.01 (0.3543in±0.0004)
M	9.04mm±0.01 (0.3559in±0.0004)
L	9.08mm±0.01 (0.3574in±0.0004)

5. Remove the eccentric shaft pulley.

6. Align the key groove of the eccentric shaft with the key grooves of the distributor drive gear, oil pump drive gear and balance weight and insert the key.

7. Fit the oil baffle plate on the eccentric shaft.

1-D-12. Installing the Front Cover

1. Place the "O" ring on the oil passage of the front housing.

2. Apply grease to the oil seal of the front cover.

3. Place the gasket on the front housing and install the front cover.

4. Tighten the front cover mounting bolts to a torque of 2.0 m-k_g (15 ft-lb), and the tension bolts to a torque of 2.5 m-k_g (18 ft-lb).

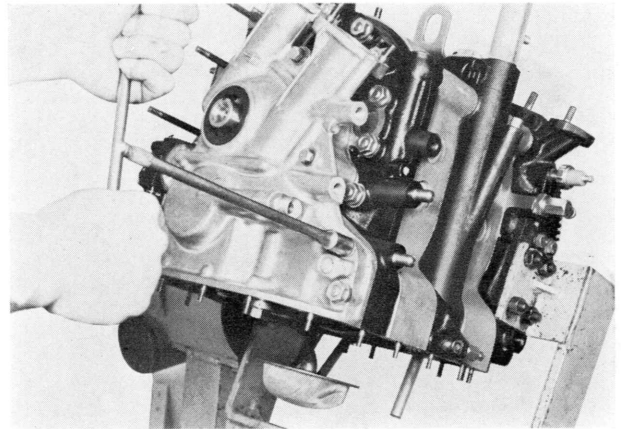

Fig. 1-107 Tightening front cover

5. Cut off surplus front cover gasket along mounting surface of the oil pan.

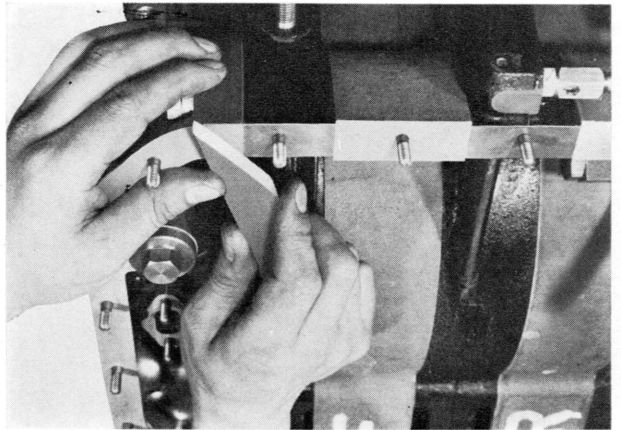

Fig. 1-108 Cutting excess gasket

1-D-13. Installing the Metering Pump

Install the metering pump on the front cover.

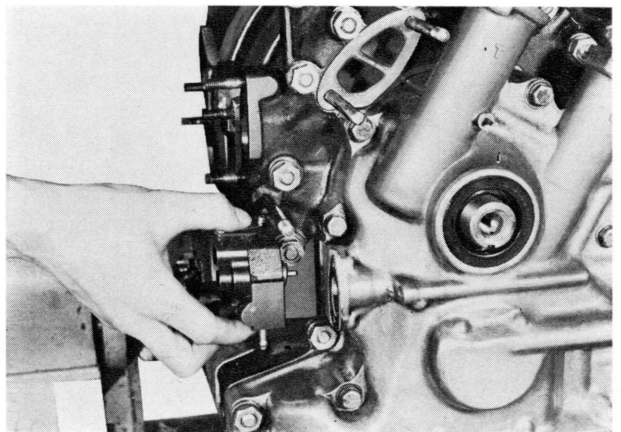

Fig. 1-109 Installing metering pump

1-D-14. Installing the Oil Strainer and Oil Pan

1. Place the gasket on the oil pump and install the oil strainer.
2. Fix the oil strainer stay with a bolt to the rear housing.
3. Apply sealing agent to the mating surface of the oil pan and each housing.

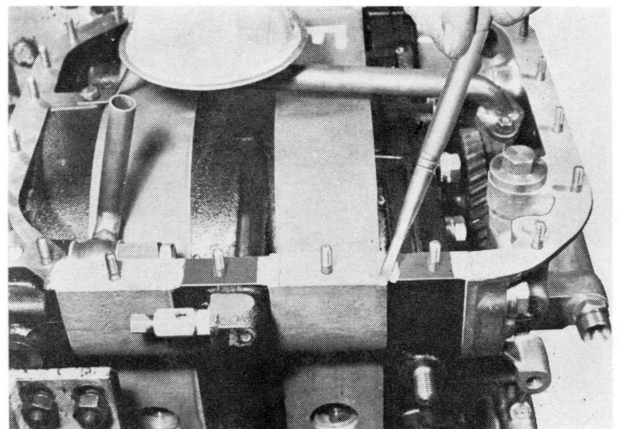

Fig. 1-110 Applying sealing agent

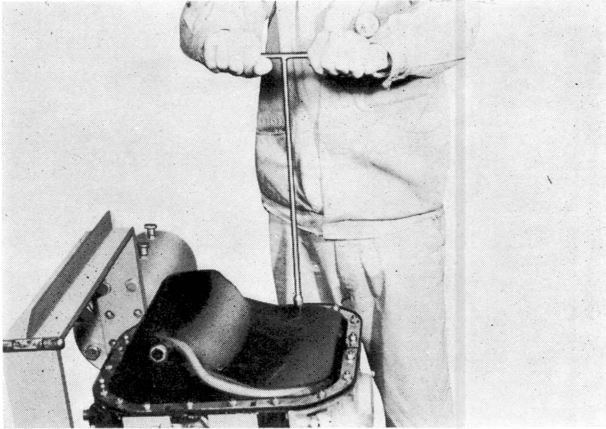

Fig. 1-111 Installing oil pan

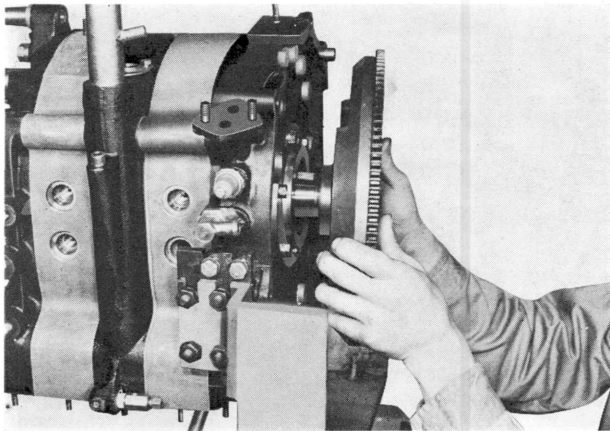

Fig. 1-112 Installing flywheel

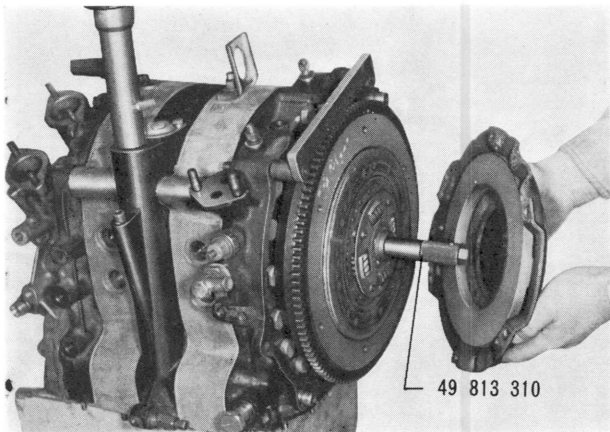

Fig. 1-113 Installing clutch assembly

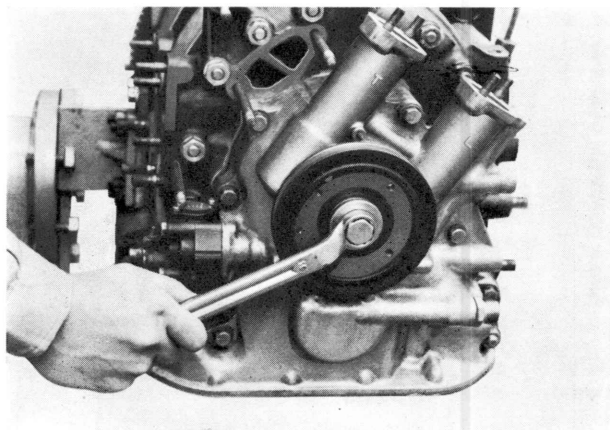

Fig. 1-114 Installing pulley

4. Install the oil pan with a gasket.
5. Install the nuts through the stiffeners.
6. Tighten the nuts diagonally until a torque of **0.6 m-kg (4.5 ft-lb)** is attained.

1-D-15. Installing the Clutch Assembly

1. Apply grease to the oil seal of the rear housing.
2. Install the flywheel to the rear end of the eccentric shaft through the key.
3. Place the lockwasher in position and install the locknut.
4. Hold the flywheel with the **ring gear brake (49 0820 060)** and tighten the lock nut to a torque of **45 m-kg (350 ft-lb)**.
5. Bend the tab of the lockwasher.

6. Hold the clutch disk and clutch assembly in mounting position and insert the **clutch disk centering tool (49 0813 310)** through the spline of the disk into the bearing at the rear end of the eccentric shaft.
7. **Match the "O" mark on the clutch cover with the reamed hole of the flywheel** and fit the securing bolts. Use a reamer bolt for the "O" marked hole.
8. Tighten the bolts to a torque of **2.0 m-kg (15 ft-lb)**.

1-D-16. Installing the Eccentric Shaft Pulley

1. Aligning the key of the eccentric shaft with the pulley key groove, install the pulley.
2. Tighten the eccentric shaft pulley mounting nut to a torque of **7.0 m-kg (50 ft-lb)**.
3. Remove the ring gear brake.

1-D-17. Installing the Oil Filter

Place the two "O" rings on the oil filter and install the unit to the rear housing.

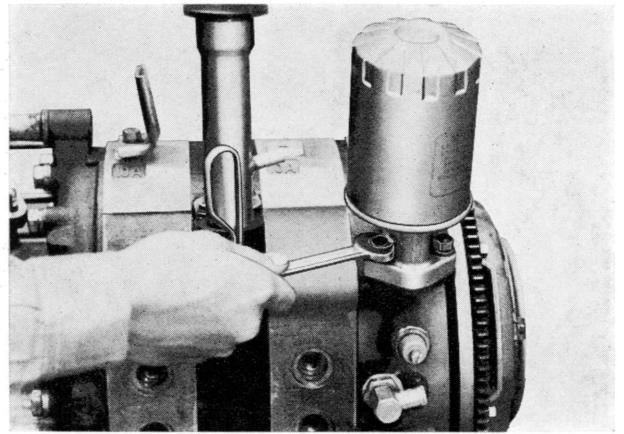

Fig. 1-115 Installing oil filter

1-D-18. Installing the Distributors

1. Turn the engine and stop when the first mark on the pulley matches the needle on the front housing.

Note: In case of the rotary engine, each rotor makes a $1/3$ rotation as against 1 rotation of the eccentric shaft. That is, 1 combustion is obtained while the rotor makes a $1/3$ rotation. Therefore, when the mark and the needle are aligned, the front rotor is always located at T. D. C. in the compression stroke.

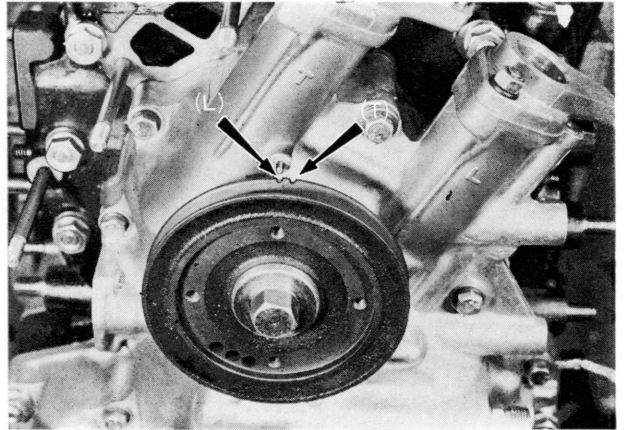

Fig. 1-116 Aligning for top dead center

2. Install the leading side distributor socket through the gasket to the front housing so that the groove on the upper side of the drive shaft points $1^{\circ}\sim 27^{\circ}$ to the right against the longitudinal axis of the engine, as shown in Fig. 1-117.

3. The distributor socket on the trailing side is mounted at an inclination of $11^{\circ}\sim 37^{\circ}$ against the longitudinal axis of the engine.

Note: The woodruff area at the upper part of the drive shaft varies with the left and right grooves, but this does not affect ignition timing even if it is 180° opposite.

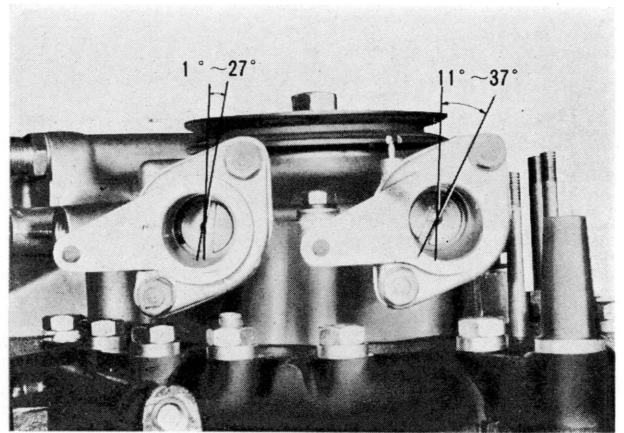

Fig. 1-117 Position of distributor sockets

4. Install each distributor on the sockets so that the key of the distributor shaft matches the slot at the upper side of distributor drive shaft.

Note: The marks of the distributor and front cover, T and L, must be matched.

5. Turn the distributors as shown in Fig. 1-118, until the contact point starts to open. Then tighten the lockplate.

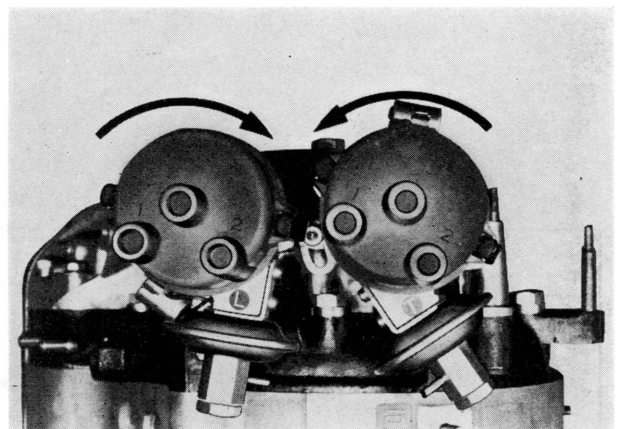

Fig. 1-118 Adjusting ignition timing

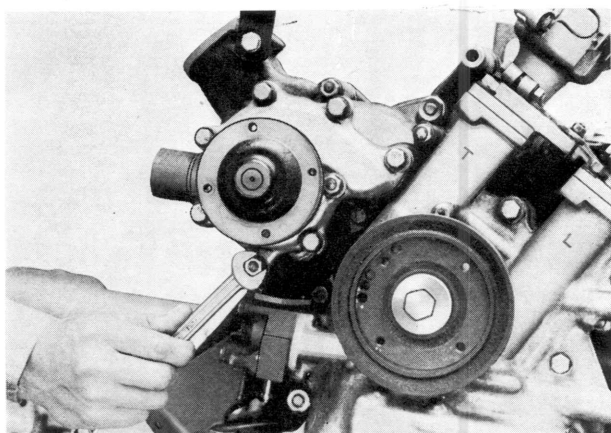

Fig. 1-119 Installing water pump

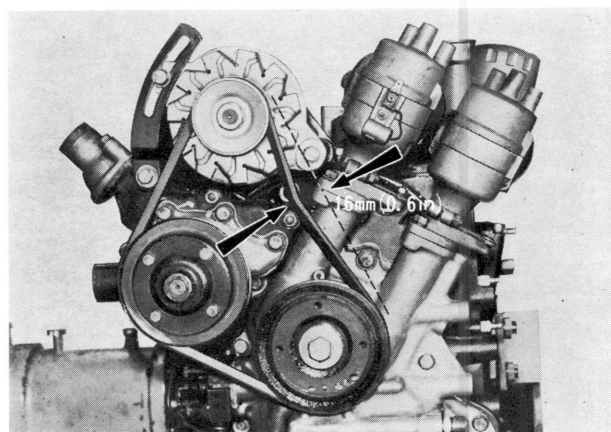

Fig. 1-120 Adjusting belt tension

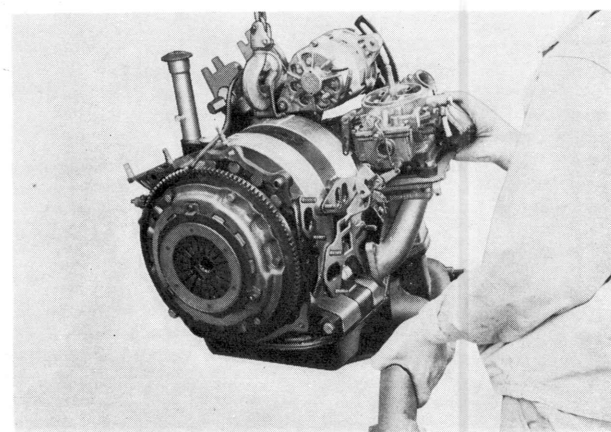

Fig. 1-121 Installing manifolds

1-D-19. Installing the Water Pump

1. Place the gasket on the front housing and install the water pump. Tighten the nuts.
2. Install the water pump pulley.

1-D-20. Installing the Alternator

1. Fix the alternator on the mounting bracket with bolt and nut.
2. Fit the V belt on the pulleys.
3. Attach the upper end of the alternator flange to the strap.
4. Move the alternator away from the engine with a lever until correct belt tension is achieved. Belt tension adjustment is correct if the belt deflection is **16 mm. (0.6 in.)** when pressing with a finger at the center point between alternator and eccentric shaft pulleys.
5. Tighten the bolts and nuts.

1-D-21. Installing the Manifold and Carburettor

1. Remove the engine from the engine stand.
2. Install the inlet manifold, exhaust manifold and carburettor with their gaskets.
3. Connect the carburettor and metering pump link.
4. Install the metering oil tube, and the distributor vacuum control tube.

1-E. ENGINE INSTALLATION

The engine is installed by reversing the removing procedures.

SPECIAL TOOLS

49 0107 680A	Engine stand	49 0813 230	Rotor clamp
49 0813 005	Engine hanger	49 0820 220	Oil seal installer
49 0820 006	Attachment, engine hanger	49 0813 235	Main bearing puller and installer
49 0813 215	Dowel puller	49 0820 260	Lock pin remover
49 0813 240	Rotor bearing puller and installer	49 0820 060	Ring gear brake
49 0813 245	Expander	49 0813 300	Flywheel puller
49 0813 225	Oil seal remover	49 0813 310	Clutch disk centering tool

LUBRICATING SYSTEM

2-A. LUBRICATING CIRCUIT	2 : 1
2-B. OIL PRESSURE RELIEF VALVE	2 : 1
2-C. OIL PRESSURE SWITCH	2 : 2
2-D. INSPECTING THE OIL PRESSURE ...	2 : 2
2-E. OIL PUMP	2 : 2
2-E-1. Oil Pump Inspection	2 : 3
2-E-2. Assembling the Oil Pump.....	2 : 3
2-E-3. Replacing the Oil Pump Gears...	2 : 3
2-F. OIL FILTER.....	2 : 3
2-F-1. Replacing the Oil Filter.....	2 : 4
2-G. OIL THERMO-VALVE	2 : 4
2-H. METERING OIL PUMP	2 : 4
2-H-1. Inspecting the Metering Oil Pump	2 : 4
2-H-2. Adjusting the Metering Oil Pump	2 : 4

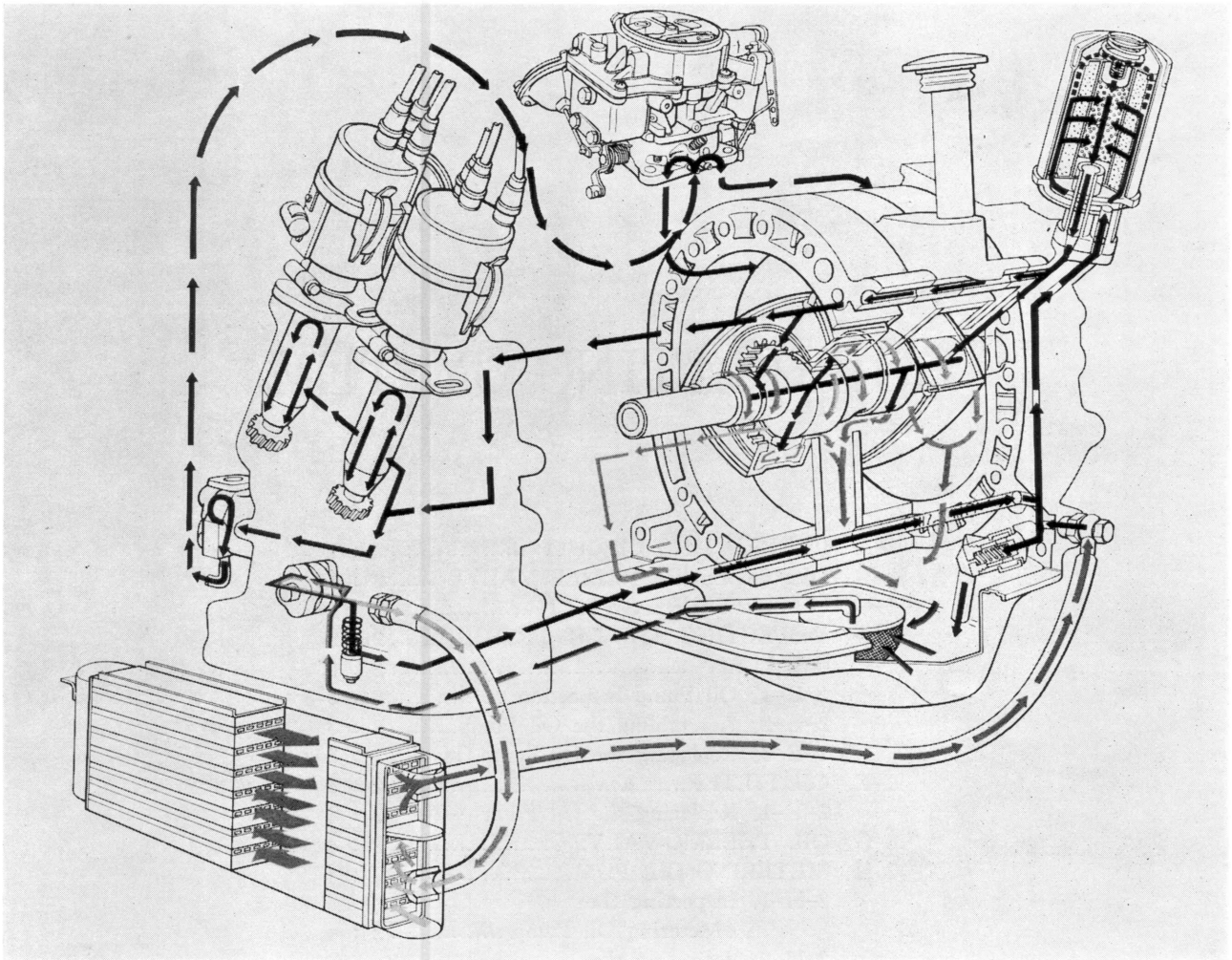

Fig. 2-1 Lubricating circuit

LUBRICATING SYSTEM

A two-rotor type pump supplies oil by forced circulation. The pump installed inside the front cover is driven by gears on the eccentric shaft.

A full-flow oil filter is provided on the rear housing of the engine. The metering oil pump delivers an adequate amount of oil into the air-fuel mixture to lubricate seals.

An oil cooler is fixed beneath the radiator. When the oil temperature rises, a thermo-valve functions to cool the oil in the cooler.

2-A. LUBRICATING CIRCUIT

1. The oil enters the oil pump through an oil strainer and is discharged to the oil filter through the oil passage of the housing.
2. When the oil temperature exceeds 71°C (160°F), the thermo-valve in the front cover functions to discharge the oil from the oil sump to the oil cooler through a hose.
3. The cooled oil passes through a hose and the oil passage of the housing and is mixed with the oil before the oil filter.
4. The filtered oil is discharged to the front main bearing through the rear main bearing and the tubular dowel.

5. After circulating through the main bearings the oil passes through the oil holes of the bearings and enters the oil passage provided in the eccentric shaft.
6. Stationary gears, internal gears and thrust bearings are lubricated with the oil discharged through the clearance between the main bearing and the shaft.

7. Oil circulating through the eccentric shaft passage lubricates the rotor bearings and further cools the rotors.

8. Oil passing through the tubular dowel is sent to the distributor and the metering oil pump.

9. From the metering oil pump the lubricant is discharged to the carburettor and is supplied into the combustion chambers together with the air-fuel mixture to lubricate between the apex seals, corner seals, side seals and the housing.

2-B. OIL PRESSURE RELIEF VALVE

The oil pressure relief valve is installed in the rear housing. The relief valve opens when the number of engine revolutions increases and the oil pressure in the lubricating system rises. Then the oil pressure is relieved and excess oil is returned to the oil sump. By this function of the relief valve, the oil pressure can be maintained at a maximum of 5.0 kg/cm² (71 lb/in²).

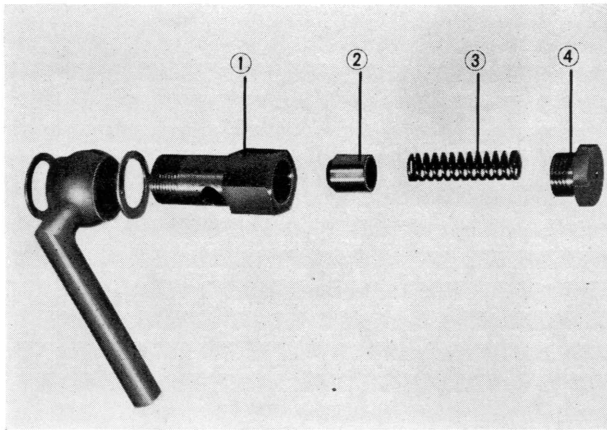

Fig. 2-2 Oil pressure relief valve

- 1. Regulator body
- 2. Control plunger
- 3. Control spring
- 4. Plug

2-C. OIL PRESSURE SWITCH

The oil pressure switch is provided on the left side of the rear housing. This switch is connected to the warning lamp on the instrument panel. The safe minimum pressure is 0.5 kg/cm² (7.1 lb/in²) during engine idling. If the oil pressure falls below 0.3 kg/cm² (4.3 lb/in²), the oil pressure switch functions to cut in the warning lamp indicating faulty lubrication. When the lamp comes on, the system has to be inspected immediately.

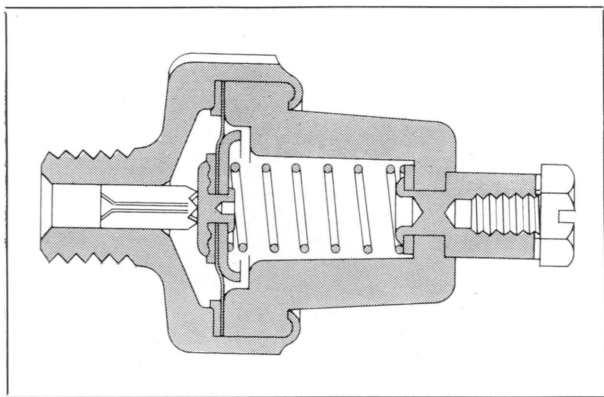

Fig. 2-3 Oil pressure switch

2-D. INSPECTING THE OIL PRESSURE

The oil pressure should be checked as follows:

1. Operate the engine until it is warmed up to the normal operating temperature.
2. Remove the oil pressure switch and connect the **oil pressure gauge** (49 0187 280) instead.
3. Operate the engine at 3,000 rpm and read the oil pressure gauge. Normal oil pressure is 3.0 ~ 5.0 kg/cm² (43~71 lb/in²).

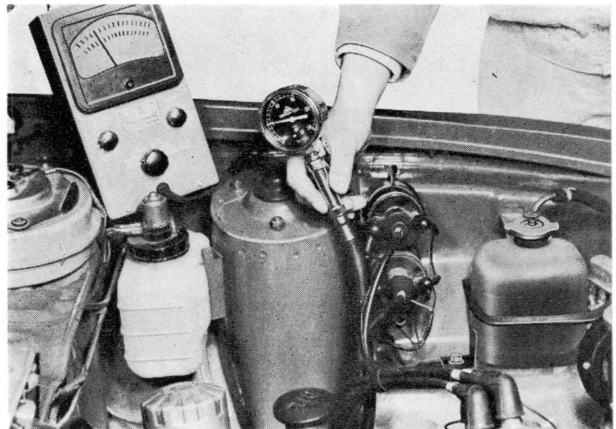

Fig. 2-4 Checking oil pressure

If the oil pressure is found extremely low, check the following points:

1. Make sure whether the oil level is between F and L on the dipstick gauge or not.
2. See if the oil filter is clogged. If clogged, replace the oil filter cartridge, referring to Par. 2-F-1.
3. Inspect the oil pump, referring to Par. 2-E-1.
4. Inspect the oil pressure relief valve for worn plunger and fatigued spring. If found defective, replace the valve.

The specifications of the spring are in the following table.

Free length	46.4 mm. (1.8268 in.)
Set length	35.3 mm. (1.3898 in.)
Set load	5.0 kg (11 lb.)

2-E. OIL PUMP

The oil pump is of a rotor type based on the trochoid curve and consists of the parts as shown in Fig. 2-5. The feeding capacity of the oil pump is 16~20 liters

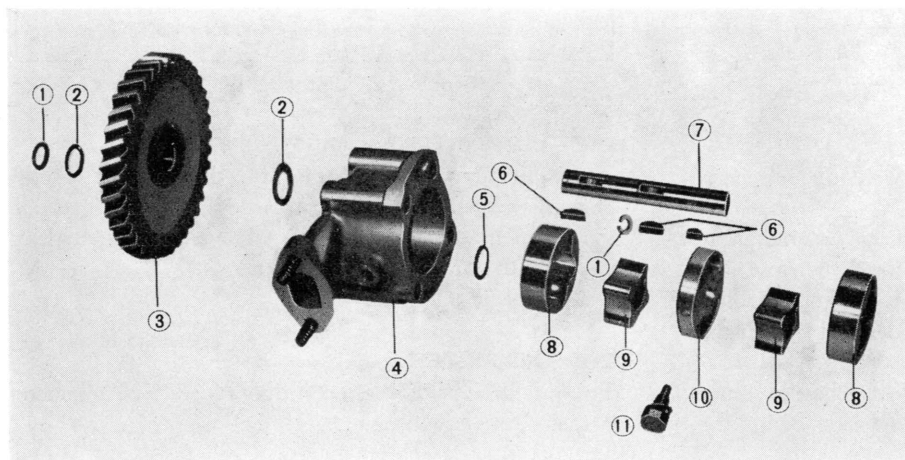

Fig. 2-5 Oil pump assembly

1. Snap ring
2. Adjusting washer
3. Oil pump driven gear
4. Oil pump body
5. Thrust washer
6. Woodruff key
7. Oil pump shaft
8. Outer rotor
9. Inner rotor
10. Intermediate plate
11. Set bolt and washer

(34~42 US. pint, 28 ~ 35 Imp. pint) per minute at 6,000 rpm.

2-E-1. Oil Pump Inspection

For checking, proceed as follows :

1. Use a feeler gauge to check the clearance between the outer rotor and the inner rotor as shown in Fig. 2-6. The standard clearance should be 0.01~0.09 mm. (0.0004~0.0035 in.).

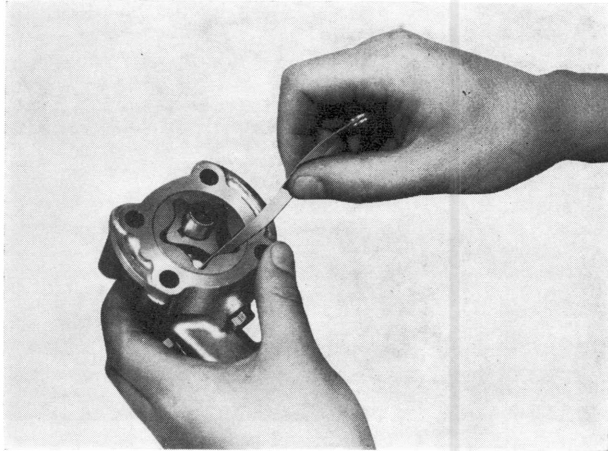

Fig. 2-6 Checking clearance between rotors

2. Measure the clearance between the outer rotor and the pump body with the feeler gauge. The specified clearance is 0.20~0.25 mm. (0.008~0.010 in.).

3. Inspect the end float of the rotor with the feeler gauge as shown in Fig. 2-7. If the end float is too large, make corrections by scraping the pump body. The standard value of the end float is 0.1~0.2mm. (0.004~0.008 in.).

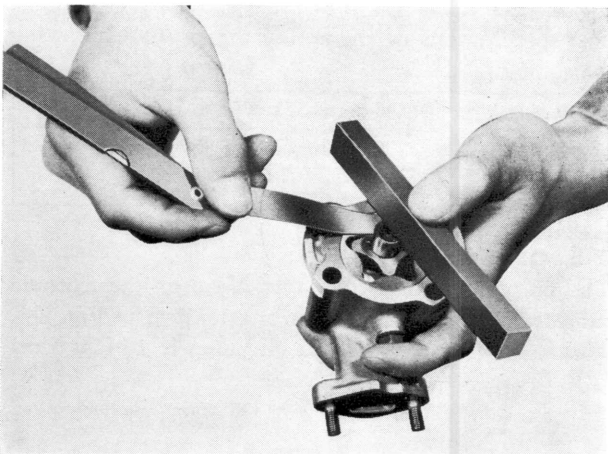

Fig. 2-7 Checking end float of rotors

2-E-2. Assembling the Oil Pump

1. Attach the stop ring and the key to the oil pump drive shaft.
2. Attach the inner rotor to the shaft by matching the key groove of the inner rotor with the key.
3. Fix the thrust washer to the stop ring of the shaft as shown in Fig. 2-8. Mount the inner rotor and shaft assembly to the pump body.
4. Apply oil to the outer rotor. Attach the outer rotor to the body with the chamfered side facing the driven gear.

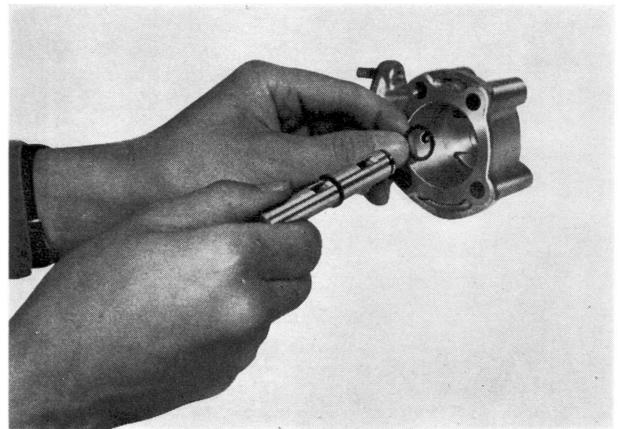

Fig. 2-8 Assembling oil pump

5. Attach the intermediate plate to the body. Tighten the screw.
6. Fix the key to the key groove of the shaft.
7. Mount the inner rotor on the shaft with matching the key groove.
8. Mount the outer rotor
9. Mount the oil pump assembly on the front cover and fix it with the bolts. Rotate the drive shaft by hand to see whether it rotates smoothly.
10. Mount the thrust washer and driven gear on the shaft (insert the key).
11. Insert an available shims between the driven gear and the stop ring so that the clearance between the oil pump body and the driven gear is 0.1~0.2 mm. (0.004~0.008 in.). The following three kinds of shims are available: 0.1 mm. (0.004 in.), 0.3 mm. (0.012 in.), 0.6 mm. (0.024 in.).
12. Then fix the stop ring.

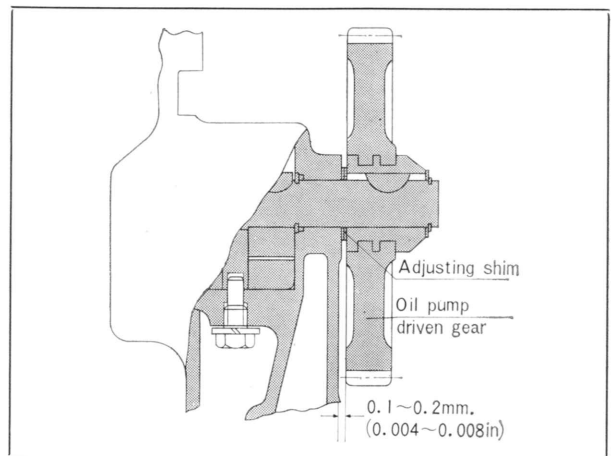

Fig. 2-9 Clearance of driven gear and body

2-E-3. Replacing the Oil Pump Gears

If the oil pump drive gear or the driven gear should be replaced, they must be replaced in pairs in order to obtain the proper backlash. The standard backlash is 0.08~0.12 mm. (0.003~0.005 in.).

2-F. OIL FILTER

The oil filter is of the cartridge type. The element is sealed in its container. The oil filter is equipped with a relief valve. When

the filter-flow resistance exceeds $0.8\sim 1.2\text{ kg/cm}^2$ ($11.4\sim 17.1\text{ lb/in}^2$) on account of clogging and contamination of the element, the relief valve is opened by the oil pressure.

The oil is then discharged directly to the engine without passing through the oil filter. The oil filter element should be replaced in intervals of 12,000 km (8,000 miles).

2-F-1. Replacing the Oil Filter

1. Using a oil filter wrench, remove the oil filter cartridge as shown in Fig. 2-10.

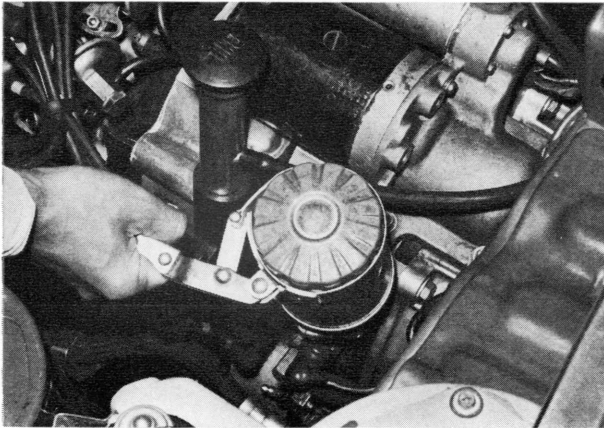

Fig. 2-10 Replacing oil filter

2. Apply oil to the rubber gasket of the new filter cartridge.

3. Install the cartridge onto the cover and screw in until it just touches the cover.

4. Tighten the cartridge a further $1/3$ of a turn but absolutely no more.

Note: After replacement, run the engine to make sure that oil leaking at the filter joints does not occur.

2-G. OIL THERMO-VALVE

The oil thermo-valve is provided on the front cover and consists of a pellet, a sliding valve and a return spring. The thermo-valve is closed at low oil temperature. At this time, the oil passes to the oil filter through the oil passage of the housing without passing through the cooler. When the oil temperature rises up to 71°C (160°F), the pellet begins to function. Then a part of the oil is sent directly to the oil filter, and the rest is cooled in the cooler before being discharged to the oil filter.

When the oil temperature reaches 86°C (187°F), the oil passage to the cooler is fully opened and the oil passage to the housing is closed completely. Then all oil is discharged to the oil filter through the cooler.

The thermo-valve should be inspected as follows:

1. Inspect the sliding surface of the slide valve to see whether there is any damage.

2. Inspect the return spring for any damage or deterioration. If the deterioration is serious, replace the spring. The free length of the spring should be 43.8 mm. (1.7244 in.).

3. Inspect the pellet by inserting it in water together with a thermometer. Stir the water and gradually heat it. Check whether the pellet begins to function at 71°C (160°F) and lifts by 8.5 mm. (0.335 in.) at 86°C (187°F).

2-H. METERING OIL PUMP

The plunger type metering oil pump is provided to send a proper amount of oil to the carburettor. The oil enters the combustion chamber together with the air fuel mixture. Thus the sliding faces of seals and housing are lubricated.

The supplied amount of oil is controlled by the engine revolutions and the load, in the following way:

The control lever of the pump is interlocked with the throttle lever of the carburettor and moves the control shaft. The control shaft has a cam-shaped tip and is interlocked with the control pin. When the opening of the throttle valve is small, the control pin protrudes only a little. Thus the stroke of the pump plunger is small to keep the oil discharge small. When the opening of the throttle valve becomes large, the control pin protrudes further to increase the plunger stroke. Thus the amount of oil supply becomes larger.

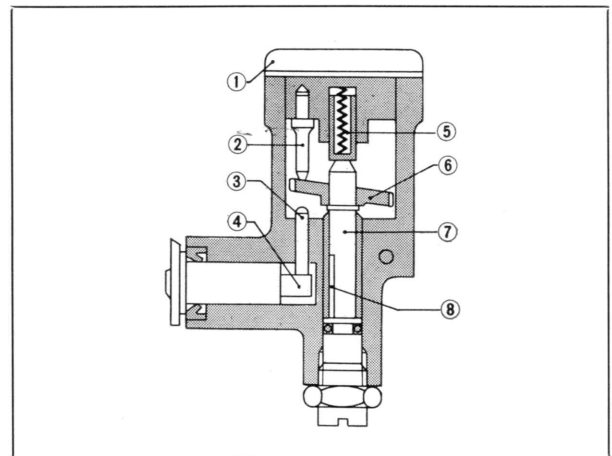

Fig. 2-11 Metering oil pump

- | | |
|----------------|--------------------|
| 1. Cover | 5. Pressure spring |
| 2. Stop pin | 6. Tilt wheel |
| 3. Control pin | 7. Plunger |
| 4. Control cam | 8. Recess |

2-H-1. Inspecting the Metering Oil Pump

The amount of oil discharge from the oil metering pump should be inspected as follows:

Disconnect the oil tube, which is connected with the carburettor, from metering oil pump. Set the engine so as to revolve at 2,000 rpm. Check the amount of oil discharged from the oil tube of the oil metering pump and if it is $6.5\pm 1\text{ cc}/10\text{ min.}$, discharge of oil is normal. Otherwise, adjust the oil metering pump.

2-H-2. Adjusting the Metering Oil Pump

For adjustment of the oil metering pump, the amount of oil discharge will be increased by turning the adjust screw clockwise as shown Fig. 2-12 and be decreased by turning it counterclockwise. After adjusting the oil

metering pump, recheck the amount of oil discharge and inspect the clearance between the stopper of the connecting rod and the control lever of the oil metering pump. When it is not correct, adjust it by bending the connecting rod.

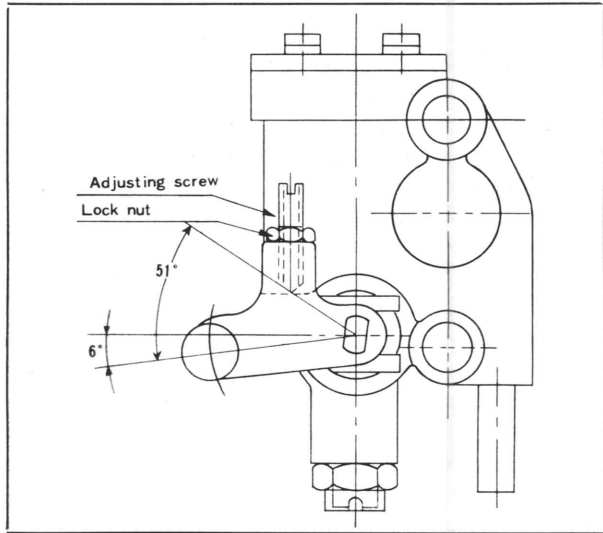

Fig. 2-12 Metering oil pump

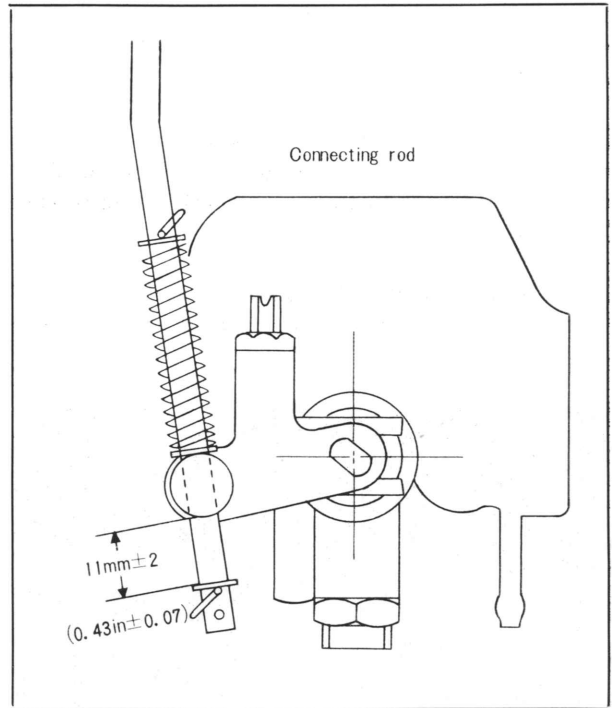

Fig. 2-13 Clearance of stopper and lever

COOLING SYSTEM

3-A. COOLANT CIRCULATION	3 : 1
3-B. MAZDA GENUINE LONG LIFE COOLANT.....	3 : 1
3-C. FLUSHING THE COOLING SYSTEM.....	3 : 1
3-D. RADIATOR	3 : 2
3-D-1. Pressure Cap.....	3 : 2
3-E. THERMOSTAT	3 : 2
3-F. WATER PUMP	3 : 2
3-F-1. Disassembling the Water Pump.....	3 : 2
3-F-2. Assembling the Water Pump ...	3 : 3

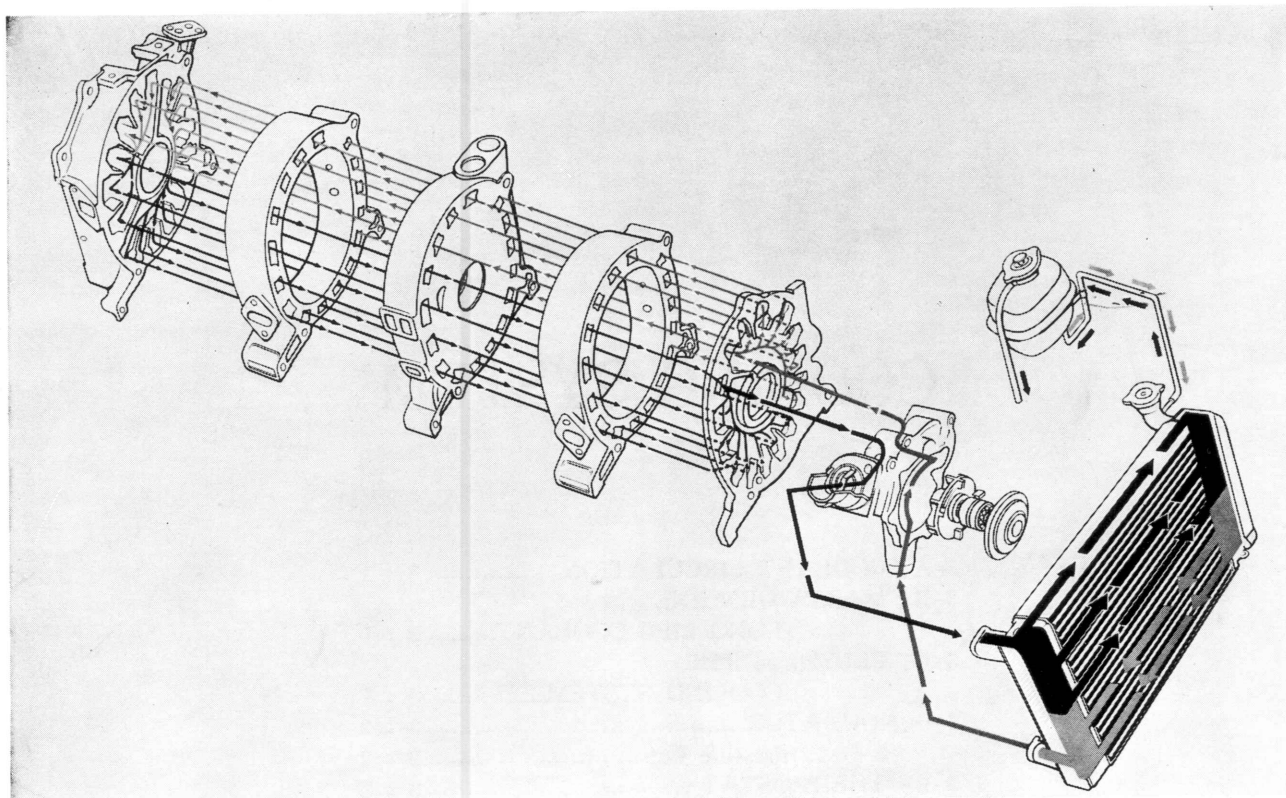

Fig. 3-1 Cooling circuit

COOLING SYSTEM

The completely sealed cooling system consists of a radiator with a sealed filler cap, an expansion chamber (sub-tank) with a pressure cap, centrifugal water pump a thermostat and a four-blade fan.

The radiator and the expansion chamber are connected by hose. When the engine is overheated, the coolant in the radiator flows out and is led into the expansion chamber through the hose. The coolant is then returned to the radiator by negative pressure which builds up in the cooling system when the engine cools down. The coolant should be changed every two years or every 48,000 km (30,000 miles).

3-A. COOLANT CIRCULATION

The water pump is driven by the eccentric shaft pulley over a V-belt and discharges the cooling water to the front housing. The water circulates from the front housing through the water passage provided in each housing and flows to the rear housing. From the rear housing, the water is returned to the front housing. At low engine temperature, the thermostat is closed to keep the water from entering the radiator. The water is then recirculated directly to the water pump and discharged to each housing. As the thermostat opens when the engine is warmed up, the water flows into the radiator. The cooled water flows from the radiator to the water pump through the connecting hose and cools the engine by circulation.

3-B. MAZDA GENUINE LONG LIFE COOLANT

Mazda Genuine Long Life Coolant is used in the cooling system of the R100 Coupé. Mazda Genuine Long Life Coolant was developed for

the aluminum engine of Mazda cars. Antifreeze solution and anti-corrosive solution are included in this coolant.

The table below shows the mixing rate of water and Mazda Genuine Long Life Coolant. Follow the table when changing the coolant.

Freezing Point	Mixture Ratio %		Specific Gravity of Mixture at 20°C(68°F)
	Coolant	Water	
-20°C(-4°F)	35	65	1.051
-45°C(-49°F)	55	45	1.078

3-C. FLUSHING THE COOLING SYSTEM

When Mazda Genuine Long Life Coolant is in use, the coolant should be changed **every two years** or **every 48,000 km (30,000 miles)**. At the time of the coolant change, the cooling system should be cleaned as follows:

1. Open the drain cocks to drain the coolant.
2. Close the cocks. Fill with the clean soft water (demineralized water).

Note: In case the accumulation of rust and other deposits is excessive, use the cleaning solution according to the instructions given by the maker of the cleaning solution.

3. Operate the engine for about one hour, keeping the normal operating temperature.
4. Drain the coolant completely and flush clean water through the cooling system in the direction opposite to the normal coolant flow. This action causes the water to get behind the corrosive deposits and force them out.
5. Fill with a mixture of water and Mazda Genuine Long Life Coolant.

3-D. RADIATOR

The radiator is of the corrugated fin type with a sealed filler cap. A pressure cap is fixed to the expansion chamber.

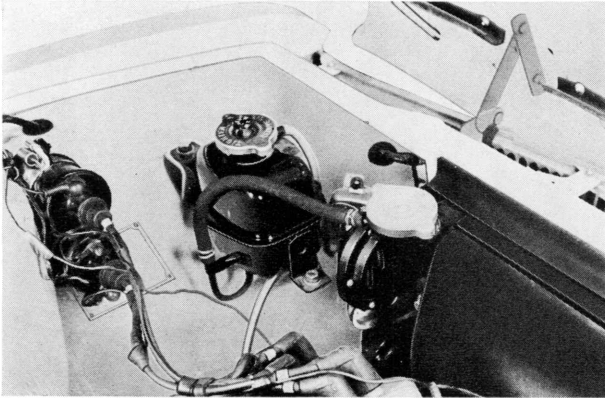

Fig. 3-2 Radiator and expansion chamber

The capacity of the radiator is 2.2 liters (0.6 US. gallon, 0.5 Imp. gallon).

Carefully inspect the radiator for water leakage. Any minor leakage must be completely eliminated by soldering or other means. A clogged radiator core badly influences the cooling effect and should be cleaned with the compressed air.

3-D-1. Pressure Cap

The pressure cap is provided on the expansion chamber. The expansion chamber and the radiator are connected by hose.

When the cooling water is pressurized, the boiling point rises and this prevents overheating and minimizes the loss of water. When the pressure in the cooling system exceeds 0.9kg/cm^2 (13lb/in^2), the pressure valve opens. When the coolant temperature falls, the vacuum release valve functions to prevent vacuum build-up in the cooling system.

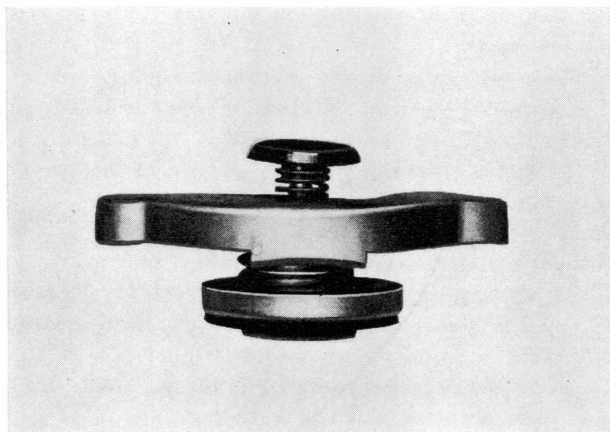

Fig. 3-3 Pressure cap

3-E. THERMOSTAT

The wax pellet type thermostat allows rapid warming up of the engine and prevents excessive cooling. The thermostat **begins to open at 76.5°C (170°F)** and **fully opens at 90°C (194°F)**. The lift at this moment is **8 mm. (0.315 in.)**.

For inspection of the thermostat, place the thermostat

together with a thermometer in water. Stir the water while gradually heating. Measure the temperature under which the thermostat begins to open and the lift. If the measured value differs excessively from the standard value, replace with a new thermostat.

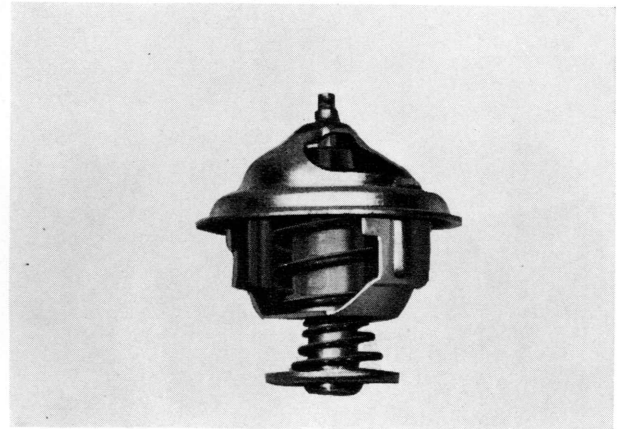

Fig. 3-4 Thermostat

3-F. WATER PUMP

The water pump is of the centrifugal impeller type. The shaft is supported in the pump body by two bearings. The impeller is fitted on the rear end of the pump shaft. The seal is made of stainless steel, carbon and rubber to prevent water leakage.

Check the water pump for leaks and excessive end play or looseness of the shaft and bearings. If there is evidence of excessive play when the pulley is manually moved up and down, it shows that the bearings are rough.

If water leaks from the hole located on the pump body, it indicates the defective seal necessitating overhaul of the pump.

3-F-1. Disassembling the Water Pump

1. Remove the screws that attach the cover to the pump body, and separate the water pump body.
2. Support the pulley boss with the **water pump puller** No. 1 (49 0813 145) and press the shaft slowly to extract the pulley boss from the shaft.

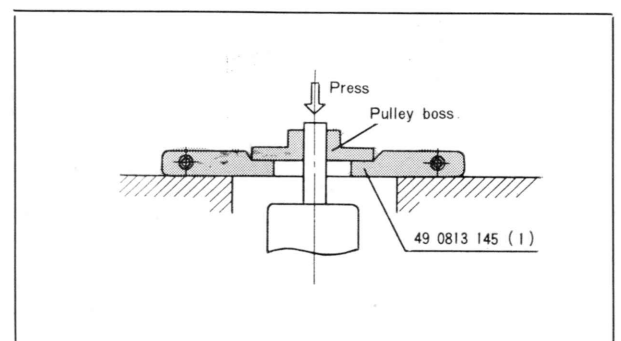

Fig. 3-5 Removing pulley boss

3. Remove the retaining ring with a suitable plier.
4. Support the front side of the water pump cover with the **water pump puller** No. 2 and apply pressure to the rear end of the shaft to press the shaft and remove the impeller, and then push the bearing assembly with shaft out through front of the cover.

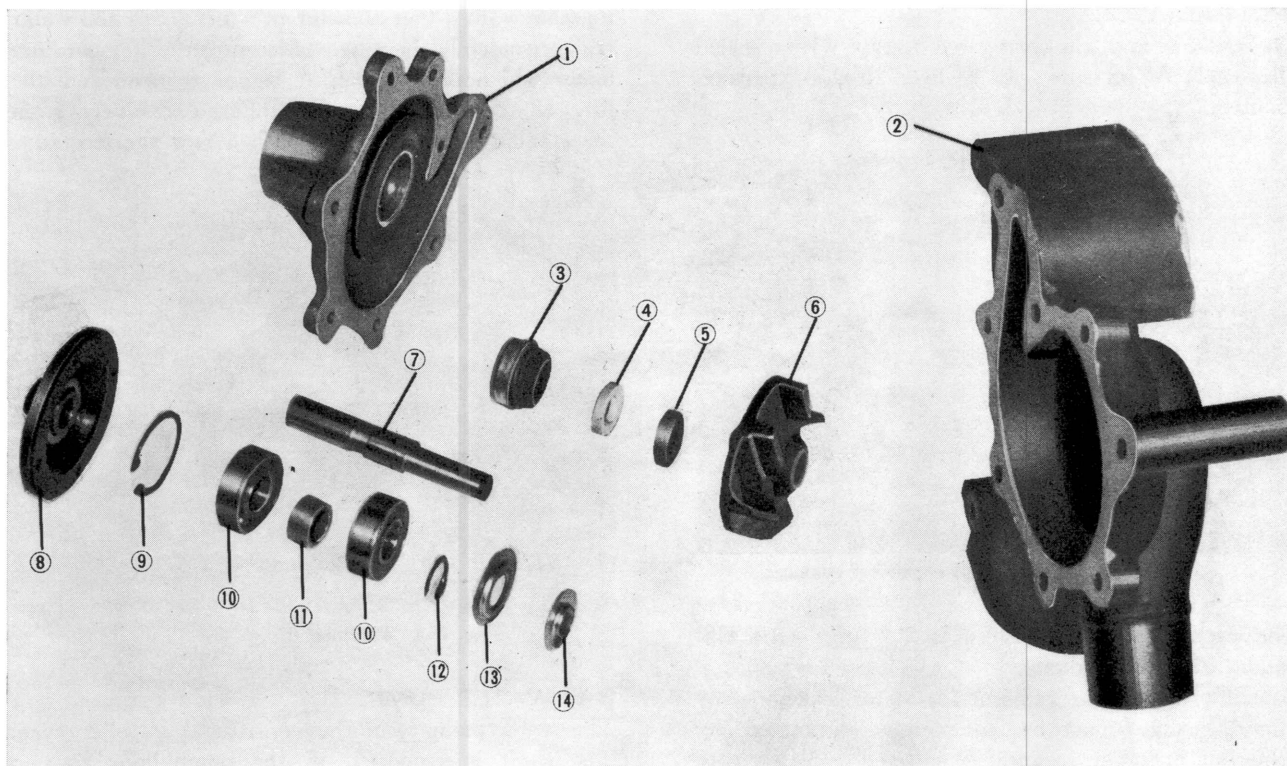

Fig. 3-6 Water pump assembly

- | | | | |
|---------------------|---------------------|--------------|---------------------|
| 1. Water pump cover | 5. Absorbing rubber | 9. Snap ring | 12. Stop ring |
| 2. Body | 6. Impeller | 10. Bearing | 13. Dust seal plate |
| 3. Seal assembly | 7. Water pump shaft | 11. Spacer | 14. Baffle plate |
| 4. Floating seat | 8. Pulley boss | | |

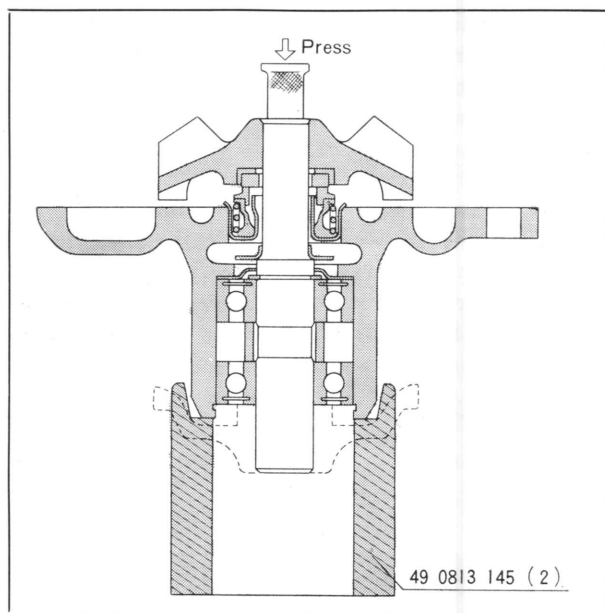

Fig. 3-7 Removing impeller

4. Remove the absorbing rubber, floating seat and water seal assembly.
5. Remove the bearings and spacer from the shaft with a suitable puller.

3-F-2. Assembling the Water Pump

When assembling the water pump, refer to Fig. 3-6 and proceed as follows:

1. Fit the stop ring into the groove of the shaft.
2. Place the dust seal plate on the stop ring and drive the baffle plate onto the taper of the shaft.
3. Install the washer and pressfit the bearing with the sealed side rearward.
4. Install the water seal assembly into the cover.
5. Press the shaft and bearing into the cover using a suitable tool.
6. Place the spacer on the bearing and fill grease.
7. Pressfit the bearing with sealed side forward until the retaining ring can be inserted.
8. Install the snap ring into the groove of the cover to retain the bearings in position.
9. Press the pulley boss onto the shaft until the boss comes in contact with the bearing.
10. Apply soapsuds to the seal pocket of the impeller and insert the absorbing rubber and floating seat into it.
11. Press the impeller assembly onto the shaft until it is flush with the end of the shaft.
12. Install the cover and gasket to the body.

SPECIAL TOOL

49 0813 145 Water pump puller

FUEL SYSTEM

4-A. CARBURETTOR.....	4 : 1
4-A-1. Carburettor Function	4 : 1
4-A-2. Disassembling the Carburettor...	4 : 3
4-A-3. Carburettor Inspection	4 : 4
4-A-4. Assembling the Carburettor	4 : 4
4-A-5. Carburettor Adjustment.....	4 : 4
4-B. FUEL PUMP	4 : 5
4-B-1. Fuel Pump Test	4 : 5
4-B-2. Disassembling the Fuel Pump...	4 : 6
4-B-3. Fuel Pump Inspection.....	4 : 6
4-B-4. Assembling and Adjusting the Pump.....	4 : 6
4-C. FUEL FILTER	4 : 7
4-D. AIR CLEANER	4 : 7
4-E. ENGINE OVERSPEED ALARM	4 : 7

FUEL SYSTEM

The fuel system consists of the fuel tank, the fuel lines, fuel filter, fuel pump, the carburettor and the air cleaner.

The capacity of the fuel tank is 60 liters (15.85 US. gallons, 13.20 Imp. gallons) The operating fuel is regular gasoline.

4-A. CARBURETTOR

R100 Coupé is equipped with a 2-stage 4-barrel Zenith Stromberg carburettor. This carburettor comprises two sets each of primary barrels (for normal use) and a secondary barrels (for high output). In addition, a float circuit and a transfer system for the primary and secondary stages are attached. The primary barrel is equipped with a choke circuit, a low speed circuit and an accelerating circuit.

4-A-1. Carburettor Function

a. Float circuit

The float chamber is equipped with a float and a needle valve to keep the fuel level constant under all operating conditions.

An oil level gauge is provided in the float chamber for easy inspection of the fuel level.

The ventilation system of the float chamber is of the inner circulation type.

Thus the fuel consumption is not influenced even if

the air cleaner is clogged to a certain extent.

b. Low speed circuit

During idling and early part-throttle operation, the fuel is measured in the low speed circuit.

The fuel passes through the slow jet fitted in a branch passage of the main jet. Then the fuel is mixed with air from the slow air bleed. The air-fuel mixture then flows through the low speed passage and is ejected from the idle hole or the bypass hole.

c. High speed circuit

During operation at part-throttle or full-throttle, the fuel is supplied through the high speed circuit. The fuel in the float chamber flows through the main jet, is mixed in the emulsion tube with the air from the main air bleed, and is sprayed through the main nozzle to the venturi.

d. Accelerating circuit

The accelerating circuit measures and supplies fuel for the rapid acceleration and smooth engine operation when the throttle valve is opened at lower speed. The accelerating piston rod is connected to the primary throttle valve by a link. When the primary throttle valve is closed, the piston is raised. Then the fuel in the float chamber is sucked up into the accelerating pump cylinder through the inlet check valve. With the throttle valve open, the piston is

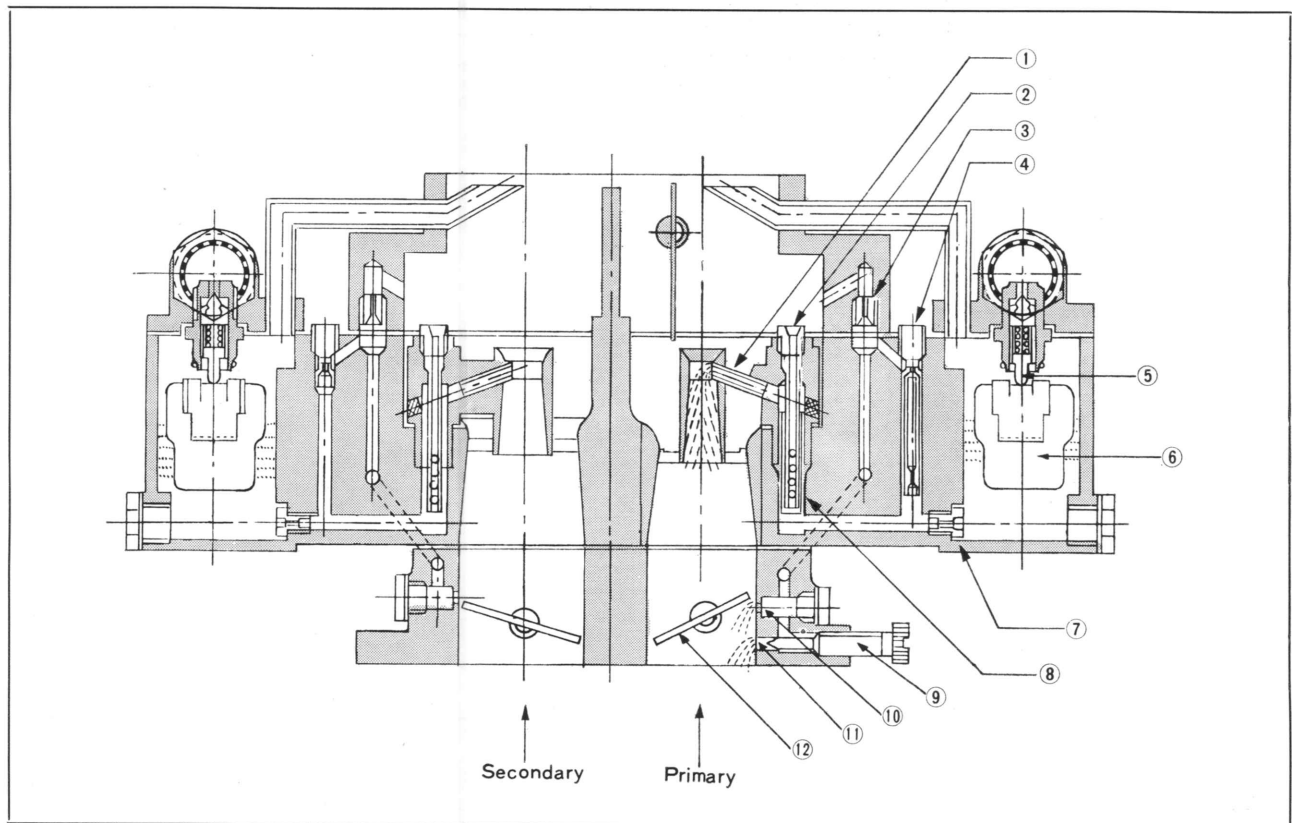

Fig. 4-1 Primary circuit

- | | | |
|-------------------|------------------|----------------------------|
| 1. Main nozzle | 5. Needle valve | 9. Idle adjust screw |
| 2. Main air bleed | 6. float | 10. Bypass hole |
| 3. Slow air bleed | 7. Main jet | 11. Idle hole |
| 4. Slow jet | 8. Emulsion tube | 12. Primary throttle valve |

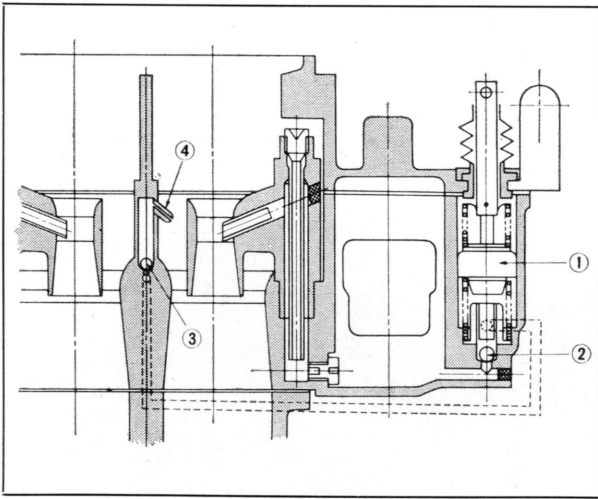

Fig. 4-2 Accelerating circuit

- 1. Accelerating piston
- 2. Inlet check valve
- 3. Outlet check valve
- 4. Pump nozzle

lowered, the inlet check valve is closed, and the outlet check valve is opened. Then the fuel in the cylinder is sprayed through the pump nozzle to the venturi.

e. Choke circuit

For easy starting and warming-up, the air intake of

the cylinder is controlled by the choke valve.

The choke valve is an offset spring loaded type and prevents excessive choking.

When the choke valve is fully closed, the throttle valve is automatically opened by the choke connecting rod to the most suitable opening (15°) for starting-up of the engine.

f. Step circuit

The step circuit corresponds to the low speed circuit of the primary barrel and improves the connection between the primary and secondary barrels.

The fuel-flow in the slow jet is mixed with air from the slow air bleed, passes through the low speed passage, and is ejected through a bore located near the fully-closed position of the secondary throttle valve.

g. Secondary high speed circuit

The secondary high speed circuit corresponds to the primary high speed circuit.

The secondary throttle valve is constructed so as to react to negative pressure in the venturi.

A vacuum jet is provided in the venturi sections of the primary and secondary stages. The average negative pressure of both jets acts on the diaphragm chamber and moves the diaphragm. The diaphragm and the secondary throttle valve are connected by link to open the throttle valve according to the

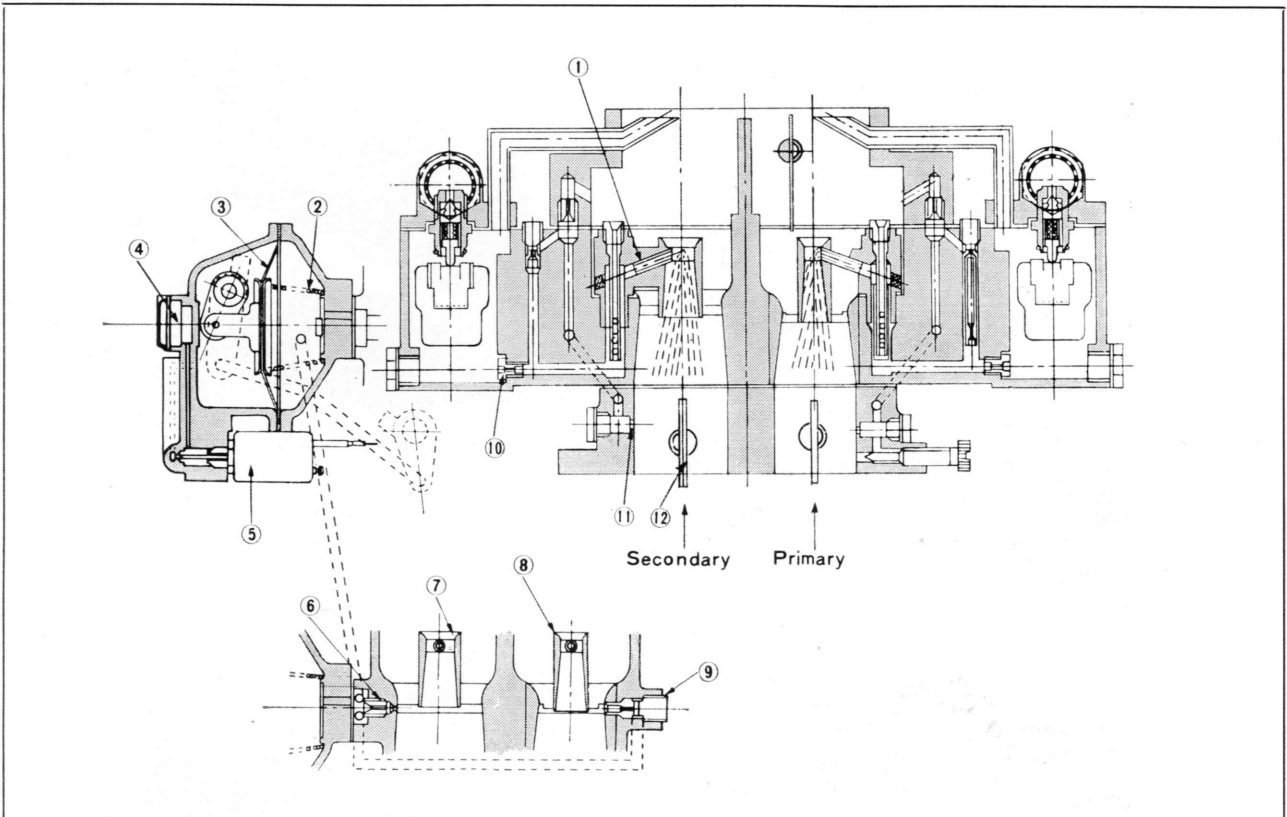

Fig. 4-3 Secondary circuit

- 1. Main nozzle
- 2. Return spring
- 3. Diaphragm
- 4. Air bleed
- 5. Solenoid valve
- 6. Secondary vacuum jet
- 7. Secondary venturi
- 8. Primary venturi
- 9. Primary vacuum jet
- 10. Main jet
- 11. Bypass hole
- 12. Secondary throttle valve

negative pressure.

However, the secondary throttle valve cannot be opened until the primary throttle valve is opened to 54° since the primary throttle valve and the secondary throttle valve are connected with each other by the link. When the opening of the primary throttle valve exceeds 54° , the secondary throttle valve opens in proportion to the negative pressure. Then the fuel from the main jet is mixed with air from the main air bleed and sprayed from the main nozzle into the venturi.

4-A-2. Disassembling the Carburettor

The carburettor should be disassembled in the following way:

1. Remove the choke connecting rod from the choke lever.
2. Remove the accelerating pump connecting rod from the pump lever.
3. Remove the screws which are fixing the air horn to the main body, and remove the air horn from the main body.

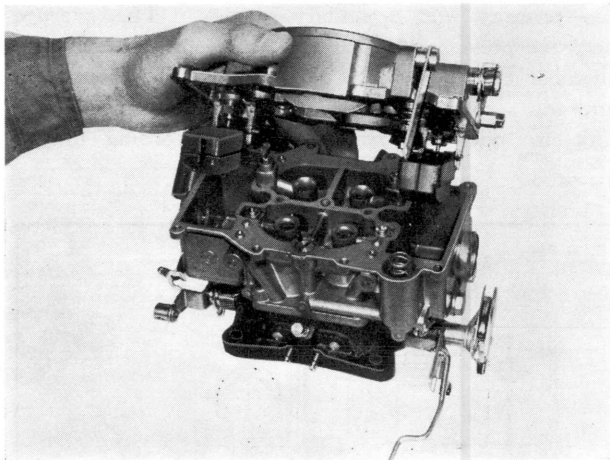

Fig. 4-4 Removing air horn

4. Take out the float pin and remove the float.
5. Remove the needle valve assembly.

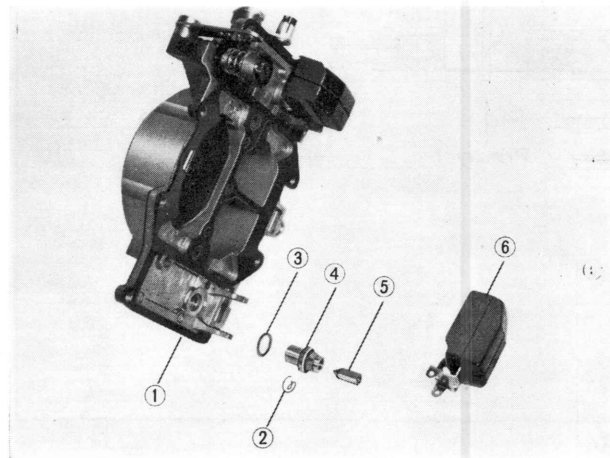

Fig. 4-5 Needle valve assembly

- | | | |
|-------------|---------------|----------|
| 1. Air horn | 3. Washer | 5. Valve |
| 2. Clip | 4. Valve seat | 6. Float |

6. Remove the accelerating pump lever and remove

the pump piston assembly from the air horn.

7. Remove the screw which is fixing the choke valve to the shaft, and dismantle choke valve and shaft from the air horn.

8. Remove the pump return spring and the inlet check valve from the pump cylinder.

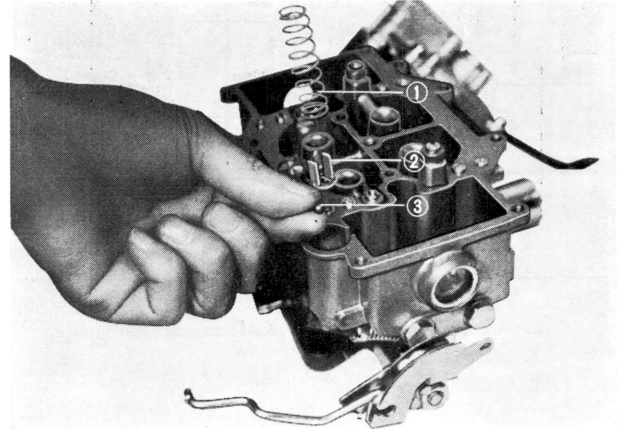

Fig. 4-6 Removing pump

- | | |
|-------------------|----------------------|
| 1. Return spring | 3. Inlet check valve |
| 2. Distance piece | |

9. Disconnect the vacuum control rod from the secondary throttle lever by removing the clip.

10. Remove the screws which are fixing the throttle body to the main body, and disconnect the throttle body from the main body.

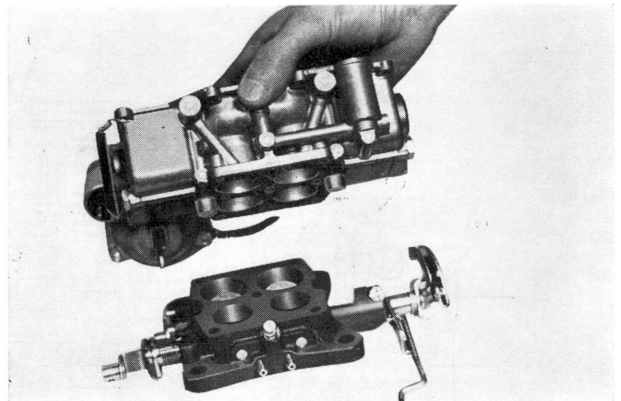

Fig. 4-7 Removing throttle body

11. Remove the pump nozzle from the main body. Remove the outlet check valve.

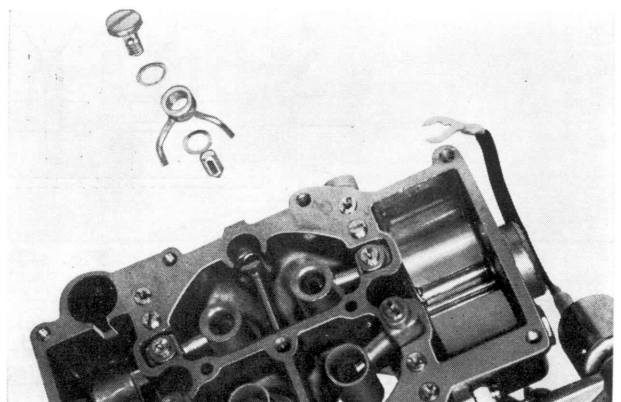

Fig. 4-8 Removing pump nozzle

12. Remove the slow jets of the primary and secondary stages and all air bleed connections from the main body.

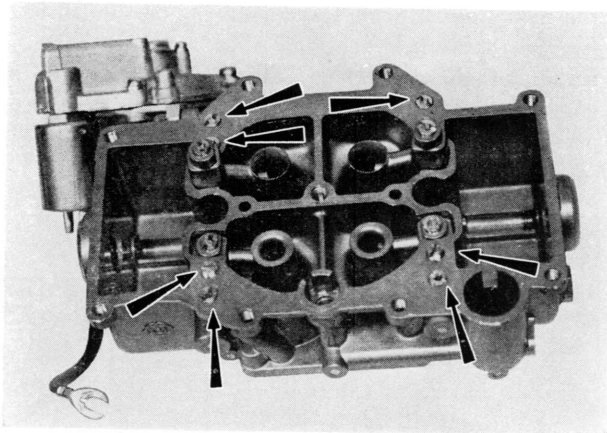

Fig. 4-9 Removing jets

13. Remove the main jet by removing the plug from the main body.

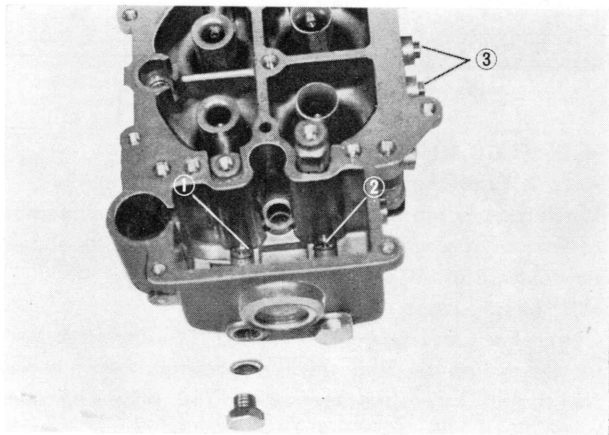

Fig. 4-10 Removing jets

- 1. Primary main jet
- 2. Secondary main jet
- 3. Vacuum jets

14. Remove the vacuum jets from the main body.
15. Remove the cover and take out the diaphragm and the return spring.

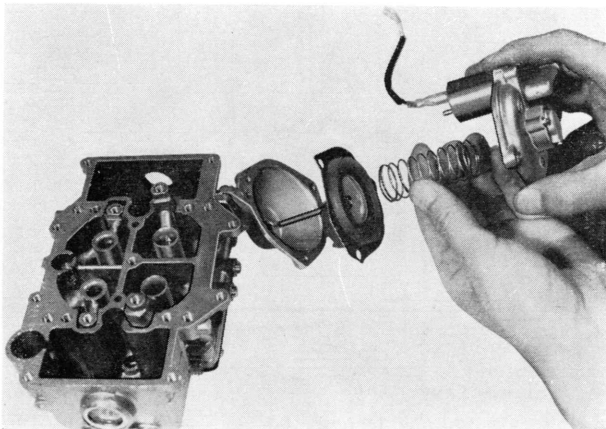

Fig. 4-11 Removing diaphragm assembly

16. Tap the venturi from the bottom for dismantling.

17. Remove the lever by removing the fixing nut of the primary throttle lever on the shaft. Remove the throttle valve and the shaft by removing screws fixing the throttle valve.

18. Remove the set screws of the secondary throttle valve and dismantle the secondary throttle valve and the shaft.

Note: Do not dismantle venturi, throttle valve and shaft, and the choke valve and shaft except when they have to be replaced on account of wear or damage.

4-A-3. Carburettor Inspection

After disassembly, inspect the carburettor as follows:

1. Wash all parts in clean detergent and dry with compressed air. All passages of the carburettor must be blown very carefully.
2. Inspect the air horn and the main body for cracks and damages, also inspect the choke shaft for wear.
3. Inspect the throttle valve for wear.
4. Inspect all jets for clogging. If clogged, wash the jet in detergent. Do not use the wire.
5. Inspect the pump piston. If damaged, replace the piston.
6. Inspect the valves of the pump to see whether they function under all operating conditions.
7. Inspect the float needle and seat for wear.
8. Check the diaphragm for damage.
9. Inspect the idle adjusting needle for burrs and ridges.
10. When assembling, only new gaskets should be used.

4-A-4. Assembling the Carburettor

The carburettor can be assembled by reversing the disassembling procedure. The following points should be kept in mind:

1. The parts of the primary barrel are similar in shape to those of the secondary barrel. Do not interchange any parts.
2. When mounting the valve, be careful to eliminate the clearance between the throttle valve and the throttle chamber wall.

4-A-5. Carburettor Adjustment

a. Float level adjustment

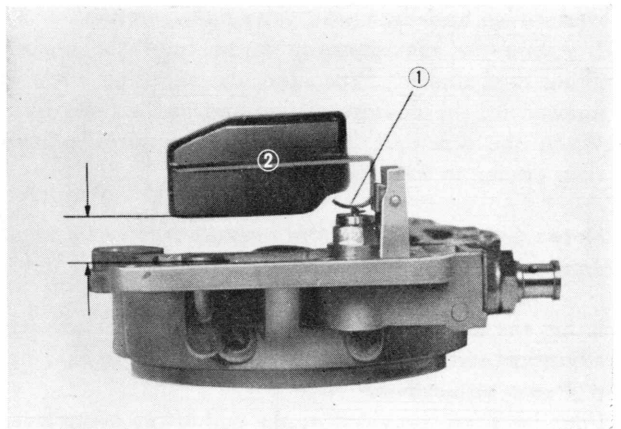

Fig. 4-12 Float level adjustment

- 1. Float seat lip
- 2. Float.

For adjustment of the float level, remove the air horn from the main body and invert it. Bend the float seat lip so that the distance between the lower face of the air horn and the upper face of float is 18 mm. (0.71 in.), as shown in Fig. 4-12.

b. Fast idle adjustment

When the choke valve is fully closed, the throttle valve opens to 15° by action of the connecting rod and provides easy starting-up. At this moment, the clearance between the throttle valve and the throttle chamber wall is 0.98 mm. (0.039 in.).

Adjust by bending the connecting rod until the proper clearance is obtained.

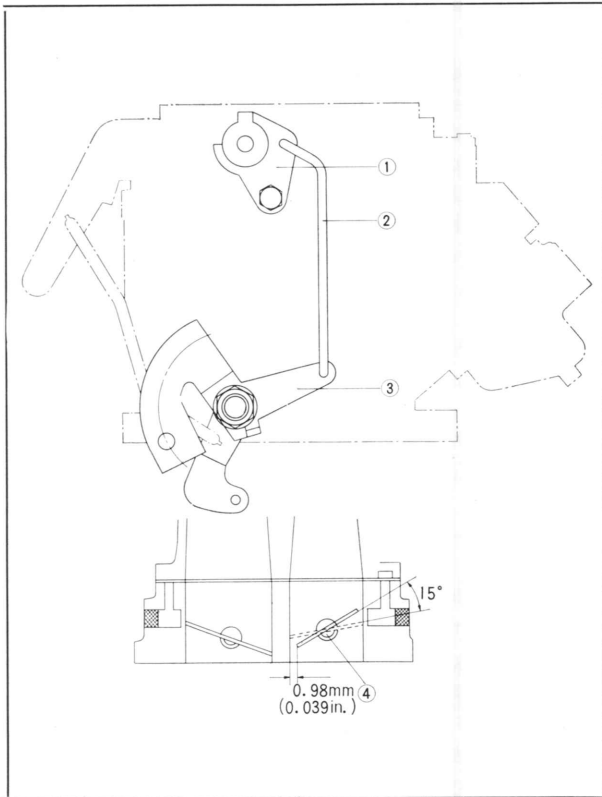

Fig. 4-13 Adjusting choke connecting rod

1. Choke lever
2. Choke connecting rod
3. Choke connecting lever
4. Primary throttle valve

c. Idling adjustment

Adjust the idling speed with the engine sufficiently warmed up and the choke valve fully opened.

1. Adjust the idle adjusting screw until the smooth idling is obtained. When the idle adjusting screw is screwed in, the mixture of fuel and air becomes lean. When the screw is loosened, the mixture becomes rich. (Refer to Fig. 4-14)

Note: Set the idle adjusting needle lightly to avoid damaging the needle.

2. Set the idling to the regular speed with the throttle adjusting screw. The normal idling speed is 700 rpm.

d. Pump adjustment

Four holes are provided at the end of the pump lever to change the stroke of the piston. If the connecting rod is connected to the hole at the extreme end,

the piston stroke is smallest, and the amount of the fuel spray will also be the minimum.

At one stroke of the piston, the delivered amount is 0.35 cc for the hole at the extreme end, 0.45 cc for the next hole, 0.65 cc for the third hole and 0.90 cc for the fourth hole.

Either of these holes is selected depending on the engine condition, driving conditions and the temperature.

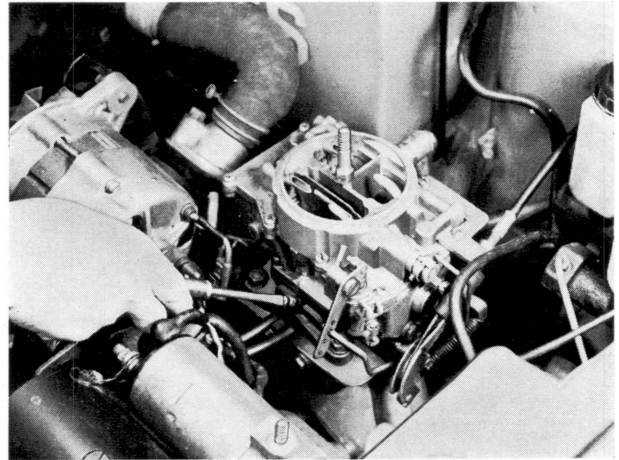

Fig. 4-14 Adjusting idle

4-B. FUEL PUMP

4-B-1. Fuel Pump Test

If the fuel pump does not supply the proper amount of fuel to the carburettor, the following tests should be made prior to disassembly of the pump.

a. Pressure test

Connect a vinyl pipe vertically to the discharge port of the pump to test the fuel pressure. operate the fuel pump by using kerosene. The pump operates normally if the kerosene level in the pump rises to 2.5~3.1 m. (8~10 ft.).

If defective, refer to 4-B-4 for adjustment of the fuel pressure. If still defective, disassemble the pump for inspection.

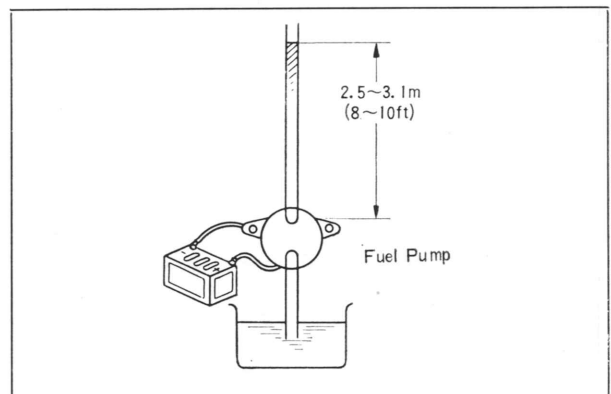

Fig. 4-15 Fuel pressure test

b. Volume test

Conduct a volume test of the fuel pump. The fuel pump should supply 1,300 cc of fuel (0.33 US. gallons, 0.28 Imp. gallons) per minute. If defective, disassemble the pump for inspection.

4-B-2. Disassembling the Fuel Pump

Observe the following procedure to disassemble the fuel pump :

1. Provide the matching marks on the air chamber, valve chamber and base so that the locations of the inlet and outlet valves are marked for assembling.
2. Remove the set screws of air chamber and valve chamber from the base. Remove the air chamber, gasket and valve chamber.
3. Attach the valve retainer and remove the screw. Remove the retainer and the valve assembly from the valve chamber.
4. Remove the cover by removing the screws which hold the cover to the body.
5. Disconnect the wiring from the switch assembly.
6. Remove the screws and dismantle the switch assembly from the body.
7. Remove the screws which are fixing the body to the base, and dismantle the body from the base.

4-B-3. Fuel Pump Inspection

1. Inspect the air chamber, valve chamber and base

for cracks and damages.

2. Inspect the diaphragm for damage and deterioration.
3. Inspect the inlet and outlet valves. If they do not function normally, replace them.
4. Inspect the points of the switch assembly for wear, burning, fusing, etc. Clean the points with a file or oil stone if defects are not serious. If serious, replace the points.

4-B-4. Assembling and Adjusting the Pump

To assemble the fuel pump, reverse the procedure for disassembling and observe the following points.

1. Inspecting the Diaphragm Shaft Stroke

After the body is attached to the base, place a dial indicator on the diaphragm shaft as illustrated. Push in the diaphragm by hand and read the graduation of the dial indicator. The reading should be 2.8~3.0 mm. (0.11~0.12 in.). When the stroke is above 3.0 mm. (0.12 in.), remove the adjusting plate which is located between the body and the base. When the stroke is below 0.28 mm. (0.11 in.), insert

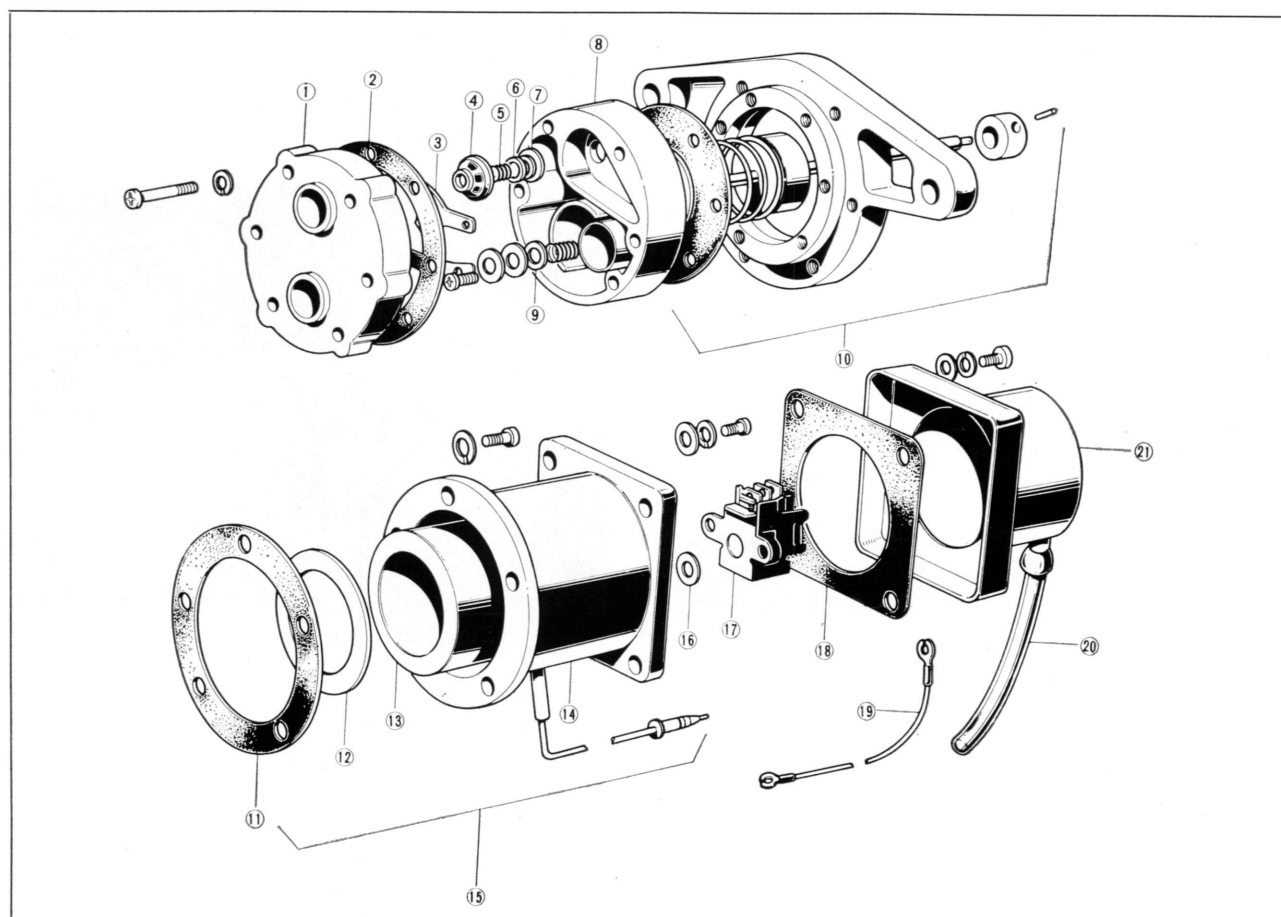

Fig. 4-16 Fuel pump assembly

- | | | |
|----------------------|---------------------|----------------------|
| 1. Air chamber | 8. Valve chamber | 15. Body ass'y |
| 2. Gasket | 9. Inlet valve | 16. Adjusting washer |
| 3. Valve retainer | 10. Diaphragm ass'y | 17. Switch ass'y |
| 4. Valve seat holder | 11. Adjusting plate | 18. Gasket |
| 5. Valve spring | 12. Plate | 19. Earth wire |
| 6. Outlet valve | 13. Coil ass'y | 20. Breather pipe |
| 7. Valve seat | 14. Body | 21. Cover |

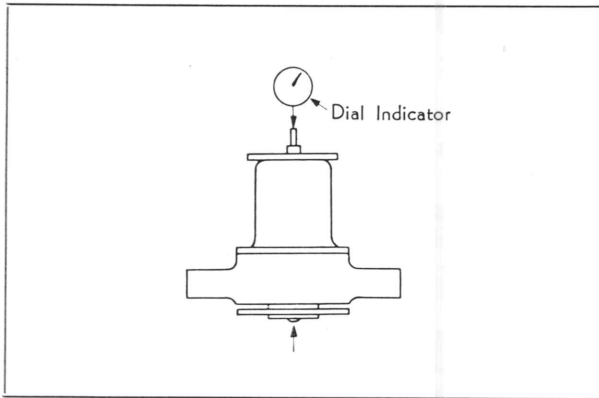

Fig. 4-17 Checking diaphragm shaft stroke

additional adjusting plate.

Three kinds of adjusting plate are available: 0.1 mm. (0.004 in.), 0.25 mm. (0.010 in.), 0.5 mm. (0.020 in.).

2. Inspecting the Switch Point

After the switch assembly is attached to the body, place the dial indicator on the diaphragm shaft as illustrated.

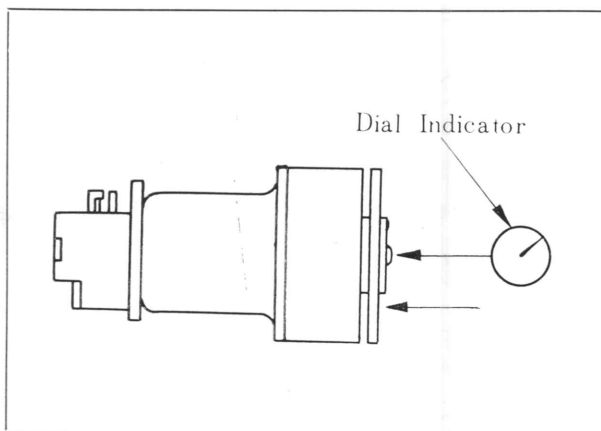

Fig. 4-18 Checking switch

Move the diaphragm shaft by hand and see whether the point of the switch assembly opens and closes at a distance of 0.5~1.0 mm. (0.020 ~ 0.090 in.) from the end of each stroke of the shaft.

If defective, adjust in either of the following two ways (1 & 2):

1) Adjustment with washers

If the point opens too early or closes too late, decrease the number of washers at the tip of the shaft. If it opens too late and closes too early, increase the number of washers. There are two types of adjusting washers: 0.25 and 0.6 mm. (0.010 and 0.024 in.).

2) Adjusting the Stoppers

If the point opens too early, bend the upper stopper upward. If too late, bend the stopper downward. If the closing action of the point is too late, bend the lower stopper upward. If too early, bend it downward. Actually, when the point opens early, the closing position becomes late. When the opening position is late, it must close early. Then it is necessary to adjust the upper and lower stoppers simultaneously.

The point gap is 1.0mm (0.040 in.) when the points are opened.

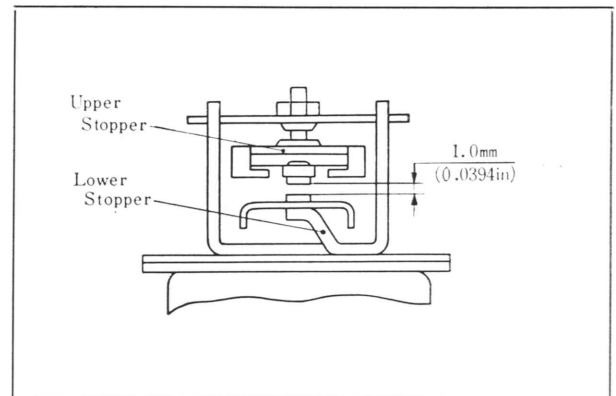

Fig. 4-19 Point gap

4-C. FUEL FILTER

The fuel filter is of the cartridge type with an integrated element and housing.

The fuel filter cartridge is held by the clamp which is attached to the lower side of the service hole cover of the luggage compartment.

Both ends of the cartridge are connected by rubber pipes.

The cartridge should be replaced at intervals of 18,000 km (12,000 miles).



Fig. 4-20 Fuel filter

4-D. AIR CLEANER

The air cleaner is of the paper element suction type. The air cleaner element should be cleaned every 3,000 km (2,000 miles) and replaced every 36,000 km (24,000 miles). Under sub-standard road conditions, the cleaner element should be cleaned every 1,500 km (1,000 miles) and replaced every 18,000 km (12,000 miles).

4-E. ENGINE OVERSPEED ALARM

R100 coupé is equipped with an alarm to prevent engine racing. This device is constructed as shown in Fig. 4-21. When the engine revolutions increase to 6,500~7,500 rpm at 13~15V, 10~50°C (50~122°F), the alarm switch connected to the ignition coil functions to sound the buzzer. At the same time, the

solenoid element admits atmospheric pressure into the diaphragm chamber. The diaphragm is then returned to the original position, and the secondary

valve of the carburettor closes. This causes lower engine revolutions and effectively prevents engine racing.

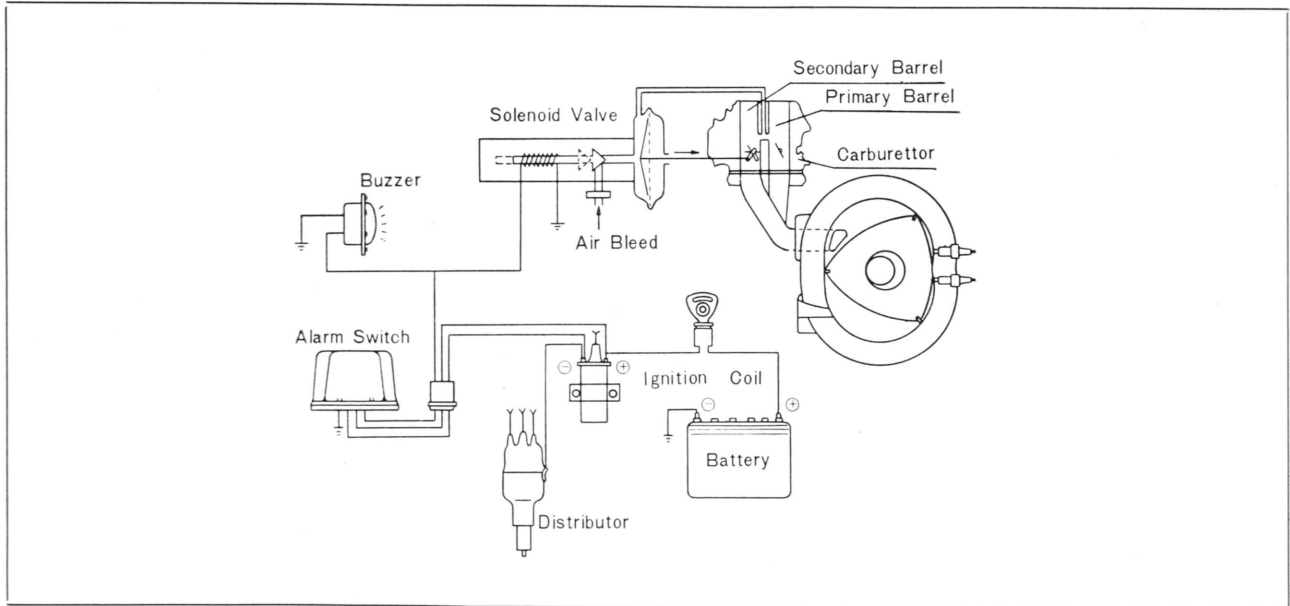

Fig. 4-21 Overspeed alarm system

ELECTRICAL SYSTEM

5-A.	BATTERY	5 : 1
	5-A-1. Checking the Battery	5 : 1
	5-A-2. Charging the Battery.....	5 : 1
5-B.	SPARK PLUG	5 : 1
	5-B-1. Checking the Spark Plug	5 : 1
5-C.	DISTRIBUTOR	5 : 2
	5-C-1. Adjusting the Point Gap	5 : 2
	5-C-2. Adjusting the Ignition Timing... 5 : 2	
	5-C-3. Testing the Distributor	5 : 2
	5-C-4. Disassembling the Distributor ... 5 : 4	
	5-C-5. Distributor Inspection.....	5 : 4
	5-C-6. Assembling the Distributor	5 : 4
5-D.	ALTERNATOR	5 : 4
	5-D-1. Service Precautions	5 : 4
	5-D-2. Checking the Charging System on Car ...	5 : 4
	5-D-3. Alternator Inspection	5 : 4
	5-D-4. Diode Replacement	5 : 6
5-E.	REGULATOR	5 : 6
	5-E-1. Checking the Constant Voltage Relay.....	5 : 6
	5-E-2. Adjusting the Regulator	5 : 6
5-F.	STARTING MOTOR.....	5 : 7
	5-F-1. Checking the Starting Circuit ... 5 : 7	
	5-F-2. Testing the Starting Motor	5 : 7
	5-F-3. Disassembling the Starting Motor.....	5 : 7
	5-F-4. Starting Motor Inspection.....	5 : 8
	5-F-5. Magnetic Switch Test	5 : 9
	5-F-6. Assembling the Starting Motor... 5 : 10	
5-G.	LIGHTING SYSTEM	5 : 10
	5-G-1. Headlight Aim	5 : 10
	5-G-2. Replacing the Bulbs.....	5 : 10
5-H.	INSTRUMENT PANEL	5 : 11
	5-H-1. Fuel Gauge.....	5 : 11
	5-H-2. Water Thermometer	5 : 11

ELECTRICAL SYSTEM

5-A. BATTERY

MAZDA R100 Coupé is equipped with a 12 volt battery consisting of six cells. Its capacity is 45 ampere hours of 20 hour rating.

The battery is located at the front right side of the engine compartment.

5-A-1. Checking the Battery

As the battery has many important functions to engine start, ignition and lighting, check the following points periodically and always keep the battery in perfect condition.

1. Check the electrolyte level in each cell of the battery, and add distilled water to maintain the solution 10~20 mm. (0.4~0.8 in.) above the plates. Do not overfill.
2. Check the specific gravity of the electrolyte with a hydrometer, as shown in Fig. 5-1. If the reading is 1.26 or more, it indicates that the battery is fully

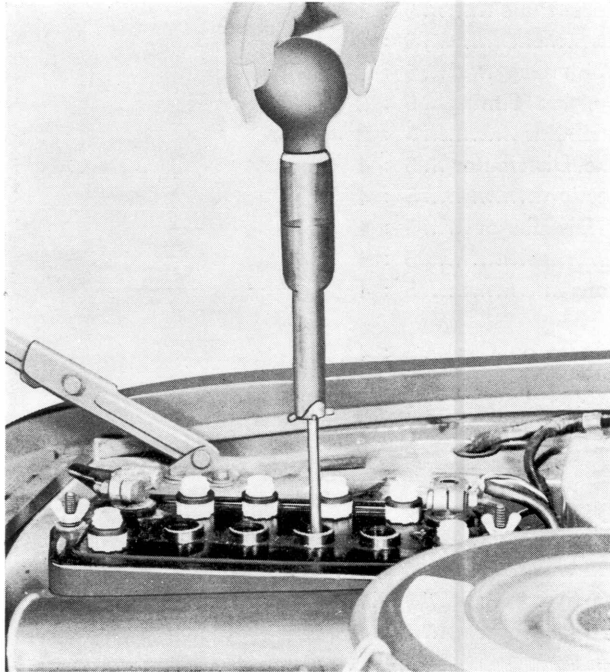

Fig. 5-1 Checking specific gravity

charged. If the reading is below 1.20, the battery requires recharging.

3. Check the tightness of the terminals to ensure good electrical connections. Clean the terminals and coat the terminals with grease.
4. Inspect for corroded or frayed battery cables.

5-A-2. Charging the Battery

a. Constant-current charge

1. If the exterior of the battery is dirty with sulphuric acid or dust and dirt, wash these off with clean water and dry thoroughly before charging the battery.
2. Check the electrolyte level and add distilled water if necessary.

Note: If addition of distilled water is neglected, the plates and separators will become exposed to

air, causing a sulphation to occur on the plates.

Do not add diluted sulphuric acid unless the electrolyte has overflowed or leaked out.

3. Connect the battery to the charger ensuring that the polarities are correct.
4. To charge, apply an electric current of approximately 5 A until the specific gravity of the electrolyte reaches 1.25~1.27.

b. Fast charge

As a fast charge causes both the temperature and the level of the electrolyte to rise suddenly, it does not have a favorable effect on the battery. Therefore, this should not be performed unless in the case of an emergency.

When a fast charge is being applied with the battery mounted on the vehicle, ensure that the cables are removed from the battery terminals before the charge is applied. If this is neglected, it could cause a damage to the diodes on the alternator.

The battery should be kept by the use of cooling water to prevent the temperature of the electrolyte from exceeding 45°C (113°F), otherwise the charging should be discontinued temporarily when the temperature rises above this point.

5-B. SPARK PLUG

The two spark plug system is adopted on MAZDA R100 Coupé for increasing the combustion efficiency. The standard spark plugs for both leading and trailing side are NGK. B-8EE or Denso W25EG. As these spark plugs are designed specially for R100 Coupé, do not replace these with any of other types of spark plugs.

5-B-1. Checking the Spark Plug

Check the spark plugs for burned and eroded electrode, black deposits, fouling, and cracked porcelain.

Clean the spark plugs with a spark plug cleaner or a wire brush if they are foul.

Replace the badly burned or eroded spark plugs.

Measure the electrode gap of each spark plug with a wire gauge. If it is improper, adjust the gap to the specified value shown in the following table, by bending the outer electrode.

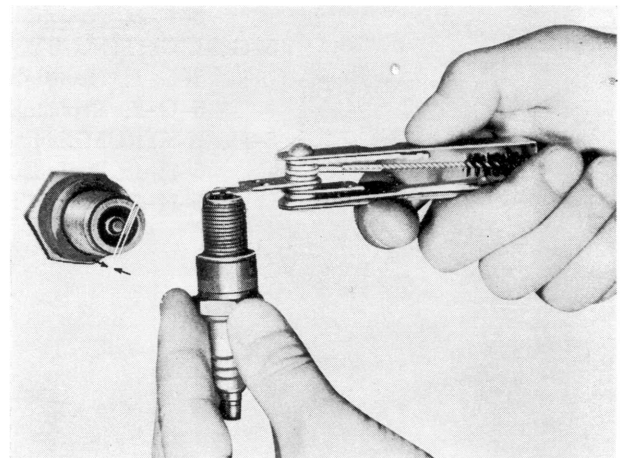

Fig. 5-2 Checking spark plug gap

Standard type

NGK	B-8EE	0.6~0.7 mm. (0.024~0.028 in.)
Denso	W-25EG	0.5~0.6 mm. (0.020~0.024 in.)

Cold type

NGK	B-9EPD	0.45~0.5 mm. (0.017~0.02 in.)
Denso	W-27Ept-A	0.5~0.6 mm. (0.020~0.024 in.)

5-C. DISTRIBUTOR

MAZDA R100 Coupé is equipped with two distributors, one for the spark plugs on the leading side and one for those on the trailing side.

Each distributor consists of distributing mechanism, contact breaker mechanism, and ignition timing advance control. The distributor on the leading side has centrifugal and vacuum controls while the one on trailing side has only the vacuum advance control.

5-C-1. Adjusting the Point Gap

Adjust the point gap of each distributor as follows:

1. Check the contact points alignment. If necessary, bend the stationary contact bracket so as to obtain contact in the center of the contact points.
2. Crank the engine and stop when the rubbing block on the contact arm just rests on the highest point of the cam.
3. Insert a feeler gauge of 0.45 mm. (0.016 in.) between the contact points, loosen the two set screws and move the stationary contact point until the correct gap is obtained.

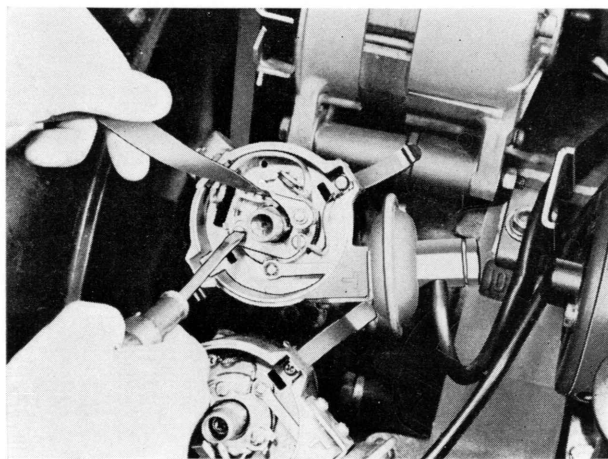

Fig. 5-3 Adjusting point gap

4. Tighten the set screws and recheck the point gap.

5-C-2. Adjusting the Ignition Timing

To obtain maximum engine performance, the distributor must be correctly positioned on the engine to give the proper ignition timing. If a timing light is available, use it to adjust the ignition timing, as follows:

1. Connect the timing light to the high tension cord for trailing side or leading side of front rotor. Start the engine and set the idle to 700 rpm.
2. Observe the position of the timing mark.
3. Loosen the distributor lock nuts and rotate each

distributor housing so that each timing mark on the eccentric shaft pulley aligns with needle on the front cover.

4. Tighten the distributor lock nuts and recheck the timing.

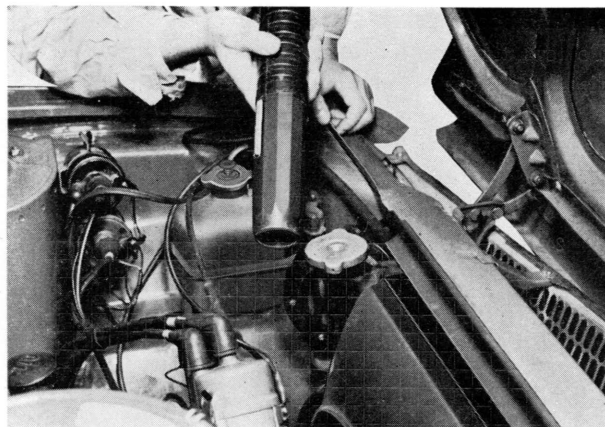

Fig. 5-4 Adjusting ignition timing

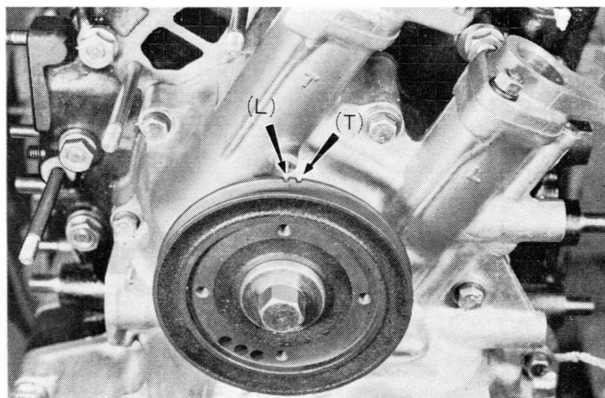

Fig. 5-5 Timing marks

5-C-3. Testing the Distributor**a. Dwell angle test**

The dwell angle also called cam angle is degrees of rotation through which the contact points remain closed.

To test the dwell angle, use a distributor tester following the instructions of the manufacturer. If the dwell reading is within 55 and 61 degrees, it is correct. If the reading is not within the specifications,

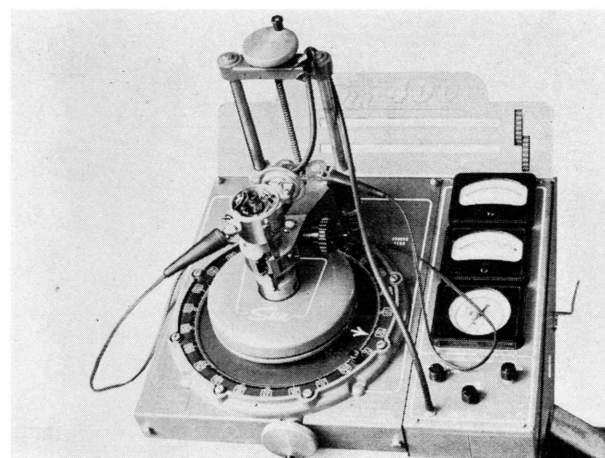

Fig. 5-6 Dwell angle test

it indicates the following troubles.

- 1) Incorrect point gap
- 2) Worn cam
- 3) Worn rubbing block
- 4) Distorted contact arm

b. Advance test

To test the ignition advancing characteristic of the distributor, use a distributor tester.

The advancing characteristic of each distributor should be within the range shown in Fig. 5-7 and 5-8.

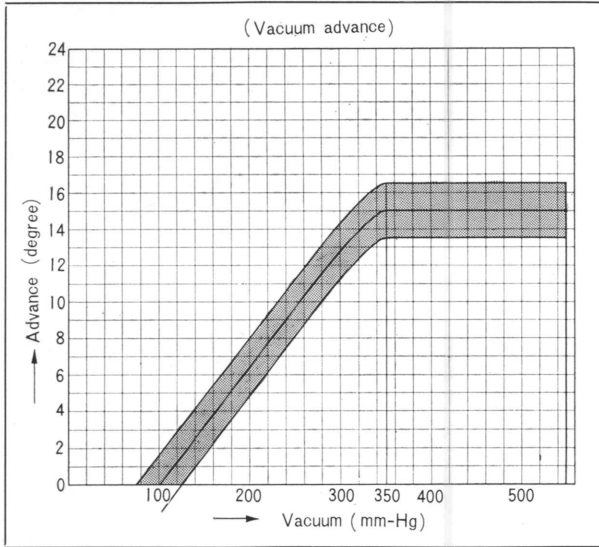

Fig. 5-7 Advancing characteristic (trailing side)

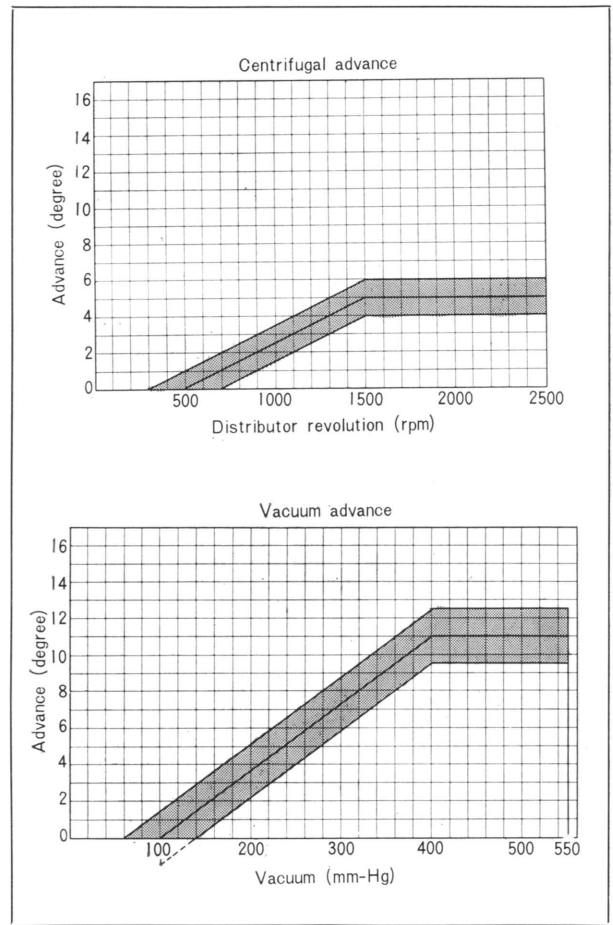

Fig. 5-8 Advancing characteristic (leading side)

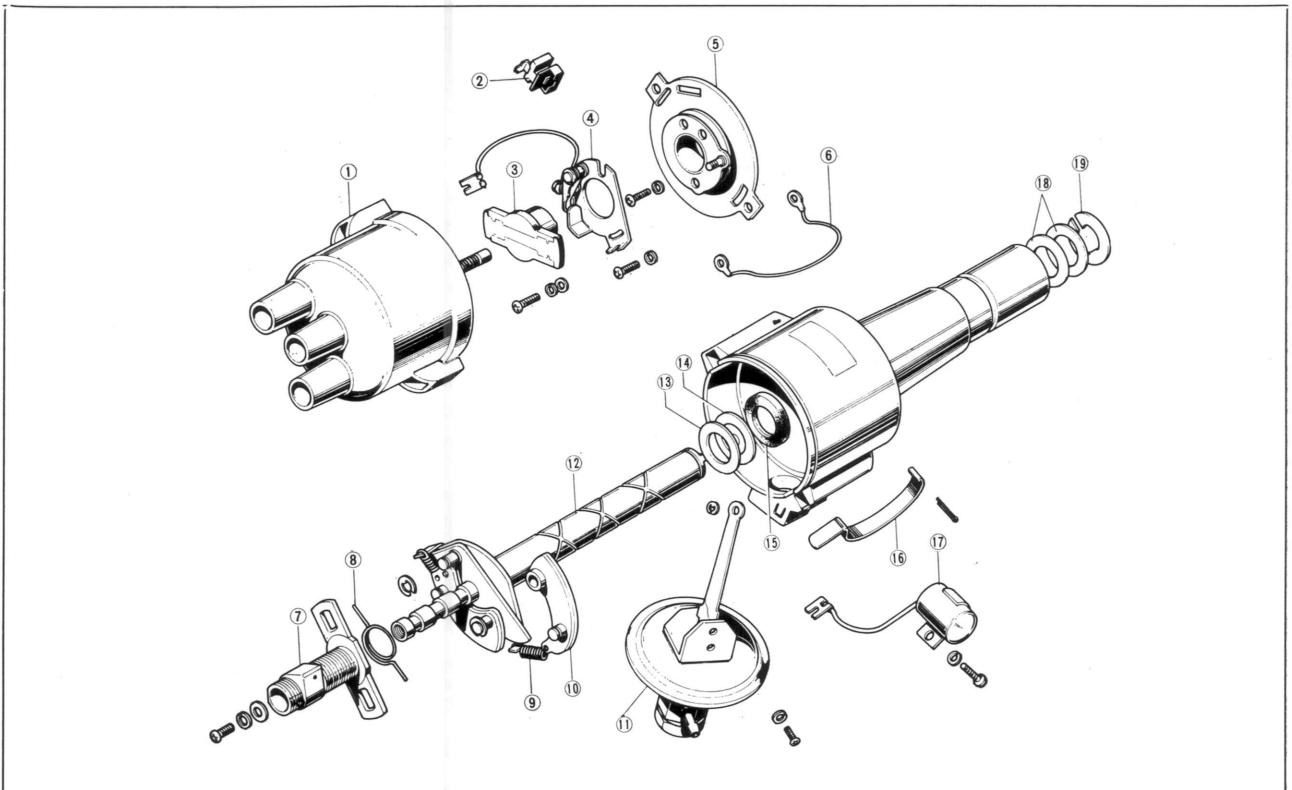

Fig. 5-9 Distributor assembly

- | | | | |
|-----------------------|---------------------|---------------------|-----------------|
| 1. Cap | 6. Earth wire | 11. Diaphragm ass'y | 16. Clamp |
| 2. Terminal | 7. Cam | 12. Shaft | 17. Condenser |
| 3. Rotor | 8. Hair pin spring | 13. Washer | 18. Washer |
| 4. Arm support ass'y | 9. Governor spring | 14. Washer | 19. Lock washer |
| 5. Breaker base ass'y | 10. Governor weight | 15. Oil seal | |

5-C-4. Disassembling the Distributor

1. Loosen the cap retaining clips and lift off the cap.
2. Remove the rotor.
3. Remove the screws that attach the vacuum control unit from the distributor housing and remove the clip holding the breaker base link. Remove the vacuum control unit.
4. Loosen the primary terminal nut and disconnect the lead. Remove the contact point assembly from the breaker base after removing the set screws.
5. Remove the primary terminal stud and insulator.
6. Remove the condenser.
7. Remove the screws that attach the breaker base and cap retaining clips to the housing. Remove the breaker base and retaining clips.
8. Take off the felt and remove the cam set screw, then remove the cam.
9. Remove the distributor drive shaft retaining clip and washers. Remove the shaft in upward direction through the top of the distributor housing.
10. The governor can be removed by removing the governor spring and clip.

5-C-5. Distributor Inspection

a. Inspection of distributor cap

Inspect the distributor cap for cracks, carbon runners and signs of arcing. Replace the cap if any of these are found. Clean the high tension terminals.

b. Inspection of rotor

Inspect the rotor for cracks or evidence of excessive burning at the end of the metal strip.

c. Inspection of contact points

Inspect the points for wear, burning, transferred metal and pitting. If the points are affected only slightly, clean with stiff metal brush or oil stone. In case of severe damage, replace the points.

d. Checking of contact arm spring tension

For inspection, hook a spring scale on the contact arm and pull straight at a right angle to the contact arm. Read the tension when the contact points start to separate. If the reading is 0.5 kg (1.1 lb) or less, replace the movable contact arm.

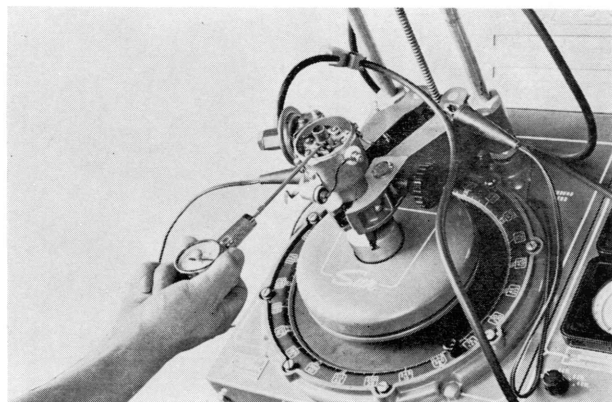

Fig. 5-10 Checking contact arm spring tension

e. Checking of condenser

If the condenser is leaky, it will cause a weak spark

or burned contact points check the capacity of the condenser with a condenser tester.

The capacity is $0.27 \pm 10\%$ microfarads. In the absence of a tester, check by substituting a new condenser.

5-C-6. Assembling the Distributor

Assemble the distributor in the reverse order of disassembling.

5-D. ALTERNATOR

5-D-1. Service Precautions

When servicing the charging system, observe the following precaution. If not followed, the result will be in serious damage of the system.

1. Do not short across or ground any of the terminals on the alternator.
2. Never operate the alternator with on an open circuit (with the field terminal connected and the armature terminal disconnected).
3. When installing a battery, always make sure that the negative post of the battery is attached securely to the ground strap.
4. Never reverse battery leads, not even for an instant, as reverse polarity current flow will damage the diodes in the alternator.
5. When charging the battery with a fast charger, disconnect the positive cable at the battery.

5-D-2. Checking the Charging System on Car

If the electrical system is not charging properly, it is advisable to determine whether the trouble is in the alternator or regulator, prior to removing the alternator.

1. Start the engine and take a reading of the ammeter on the instrument panel, holding the engine speed to 1500 rpm.
2. Disconnect the wiring from the F terminal of the alternator and short circuit the wiring to the BAT terminal of the alternator for a moment, noting the ammeter.
3. If the charging current increases remarkably, the trouble is in the regulator and if there is no change in current, it is in the alternator.

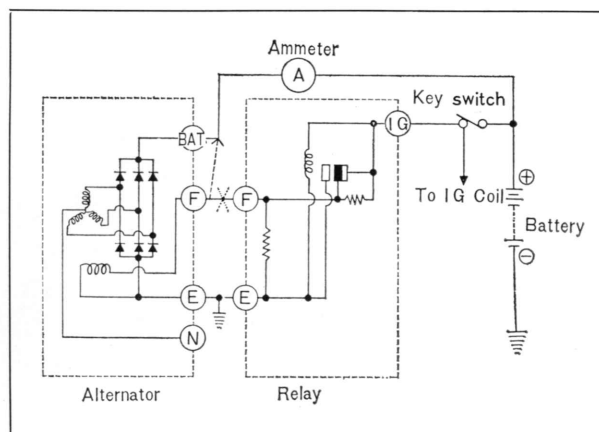

Fig. 5-11 Checking charging system

5-D-3. Alternator Inspection

a. Checking of stator coil

Check the stator coil for both open and grounded

circuits with a tester. To check for open, connect the prods to each of the two leads, as shown in Fig. 5-12. If there is no flow of current, the coil circuit is open and must be repaired or replaced.

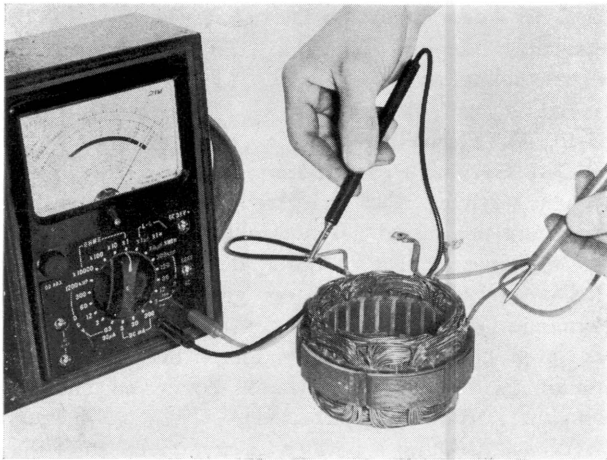

Fig. 5-12 Checking stator coil for open

To check for grounding, connect one prod to the core and the other to each lead wire. If there is current flow, grounding is indicated and the stator coil must be repaired or replaced.

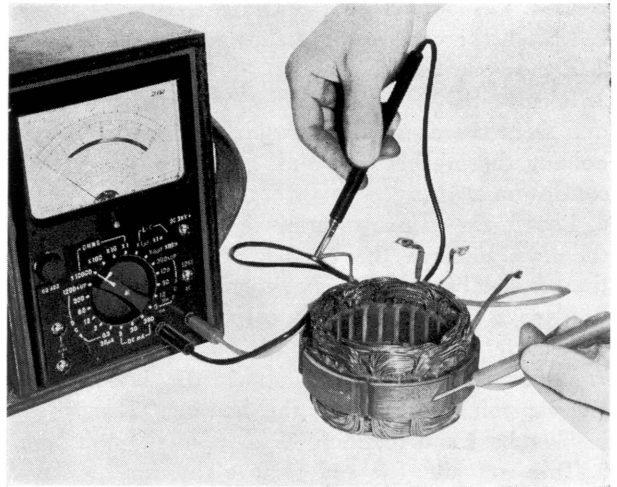

Fig. 5-13 Checking stator coil for ground

b. Checking of rotor

To check for open circuit, place both prods of a tester on the slip rings, as shown in Fig. 5-15. If the reading is 5~6Ω, the rotor is not defective.

To check for grounding, connect one prod to the slip ring and other prod to the core. If there is current flow, the rotor must be repaired or replaced.

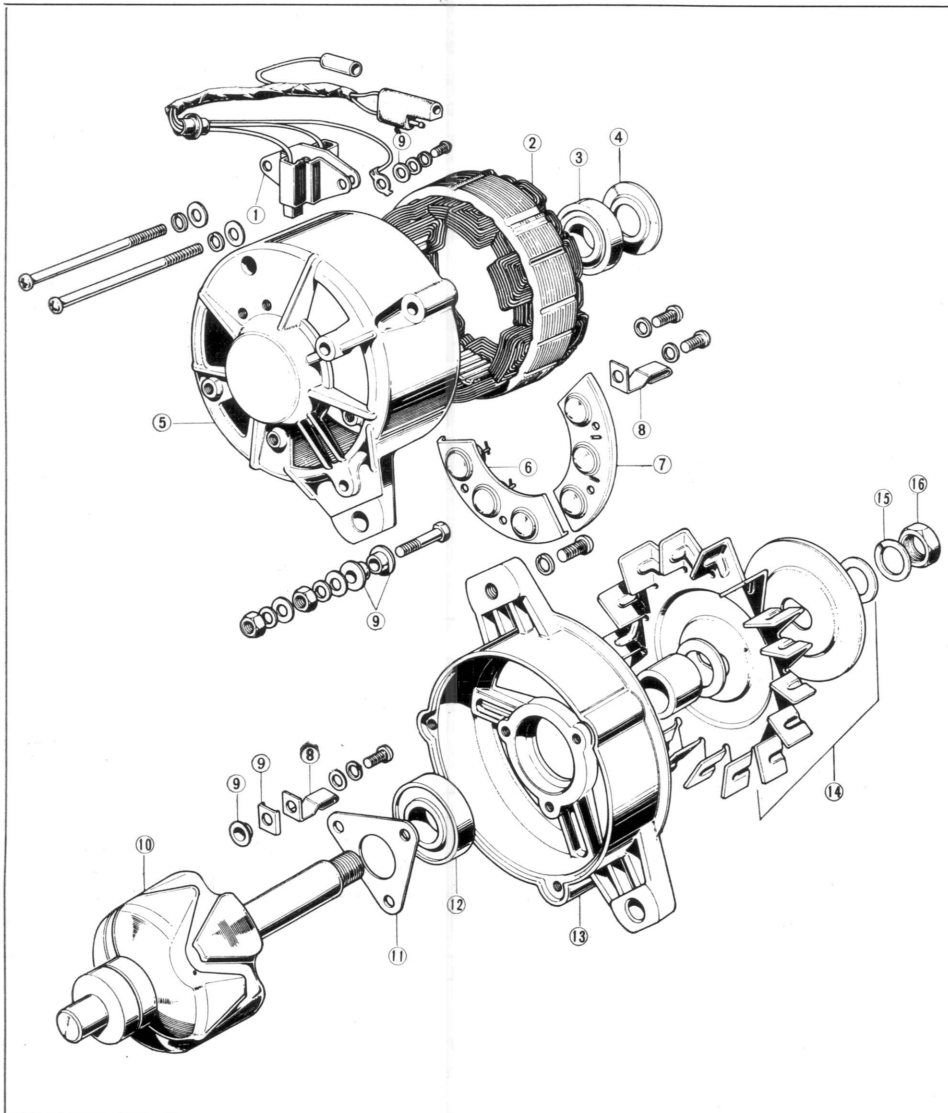

Fig. 5-14 Alternator assembly

- 1. Brush holder
- 2. Stator
- 3. Ball bearing (rear)
- 4. Seal washer
- 5. Rear bracket
- 6. Heat sink cpt. ⊖
- 7. Heat sink cpt. ⊕
- 8. Clamp
- 9. Insulator
- 10. Rotor
- 11. Bearing press plate
- 12. Ball bearing (front)
- 13. Front bracket
- 14. Pulley ass'y
- 15. Spring washer
- 16. Nut

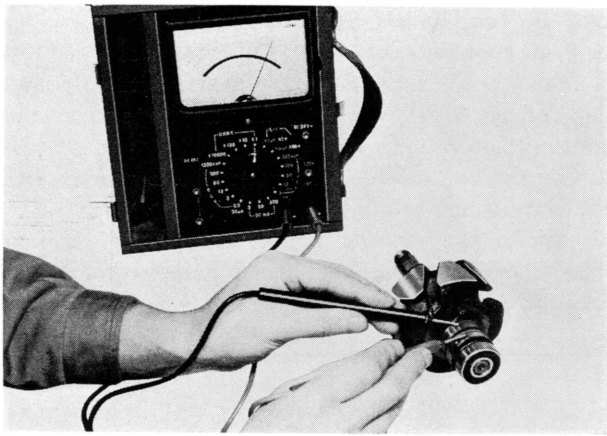

Fig. 5-15 Checking rotor

c. Checking of diode

Diodes for use in the alternator are available in two different type, the positive diode which allows current to flow from the lead wire to the case but not from the case to the lead wire (red mark) and the negative diode which has the opposite properties (black mark). To check, read the resistance between the lead wire and case with a tester. Then reverse the tester leads and note the reading. If both readings are very low or high, the diode is defective. A good diode will give one low reading and one high reading.

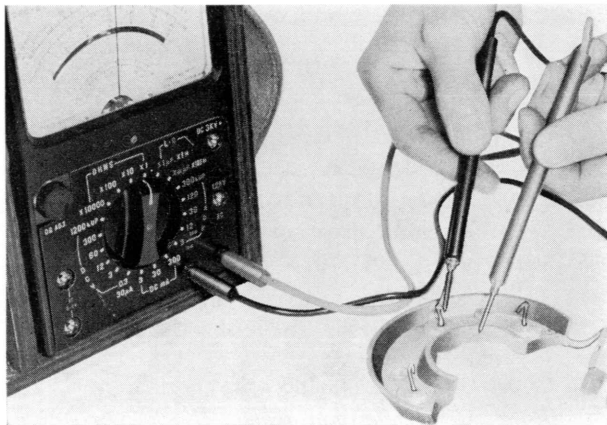

Fig. 5-16 Checking diode

d. Checking of brushes

The brushes should be replaced when one third of the original length is worn. However, as the original brushes last for 150,000~200,000 km (100,000~1300,000 miles), replacement is hardly necessary. The standard brush spring tension is 350 gr (12.5 oz). If the tension is too low os in case of excessive corrosion, the spring must be replaced.

e. Checking of bearings

As the bearings are permanently lubricated, lubricating is not required. After very long service or when the bearings are worn or damaged, new bearings should be fitted.

5-D-4. Diode Replacement

a. Removing of diode

To remove the diode, use a suitable tool to support

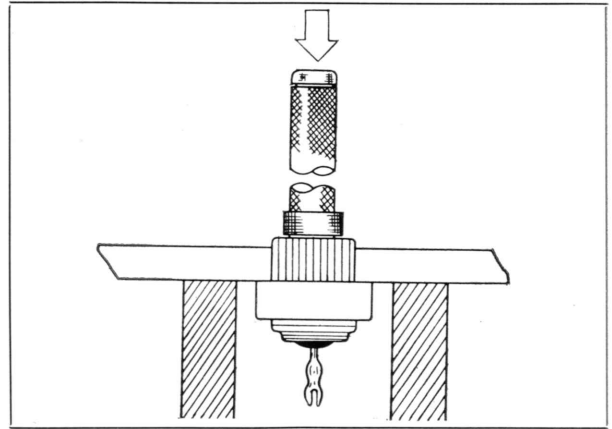

Fig. 5-17 Replacing diode

the heat sink, and push out the diode with an arbor press. Do not strike the diode, as the shock may damage it. Be sure not to damage the mounting bore of the rear bracket assembly.

b. Installing of diode

Support the heat sink with a suitable tool and then push in the diode squarely with an arbor press until the lower edge of the diode is flush with the heat sink.

c. Soldering of leads

Soldering of the diode leads should be performed in less than twenty seconds as the excessive heat may damage the diode.

5-E. REGULATOR

5-E-1. Checking the Constant Voltage Relay

To check, use an almost fully charged battery and connect a voltmeter between the A and B of the regulator, as shown in Fig. 5-18. Then, hold the alternator revolutions at 4,000 rpm (engine revolutions 1,640 rpm) and read the voltmeter. If the reading is within 14~15 volts, the regulator is in order. If it is not within the specified limit, the voltage relay must be adjusted as described in Par. 5-E-2.

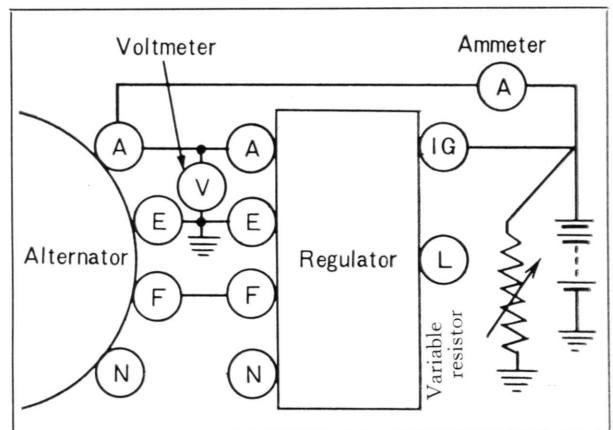

Fig. 5-18 Checking constant voltage relay

5-E-2. Adjusting the Regulator

First, check the air gap, back gap and point gap with a wire gauge. If they are not within the specifications, adjust by bending the stationary contact

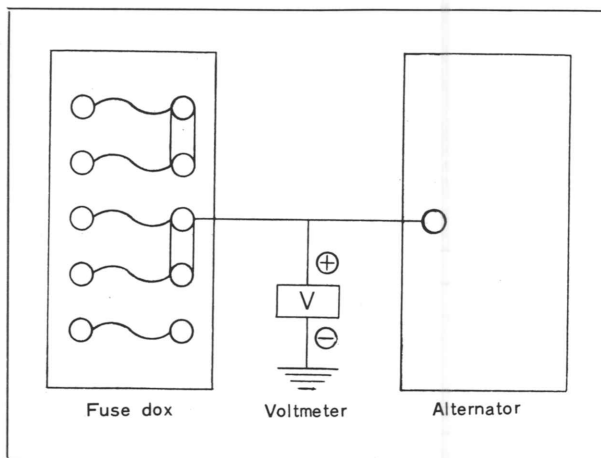

Fig. 5-19 Adjusting regulator

brackets.

After correct gaps are obtained, adjust the voltage setting. Bend the upper plate down to decrease the voltage setting, up to increase the voltage setting.

VOLTAGE REGULATOR ADJUSTMENT	STANDARD SPECIFICATION
AIR GAP	0.7~1.1 (mm.) 0.027~0.043 (in.)
POINT GAP	0.3~0.4 (mm.) 0.012~0.015 (in.)
BACK GAP	0.75~1.1 (mm.) 0.029~0.043 (in.)
REGULATED VOLTAGE WITHOUT LOAD (AT ALTERNATOR 4,000RPM)	14.0±0.5 V

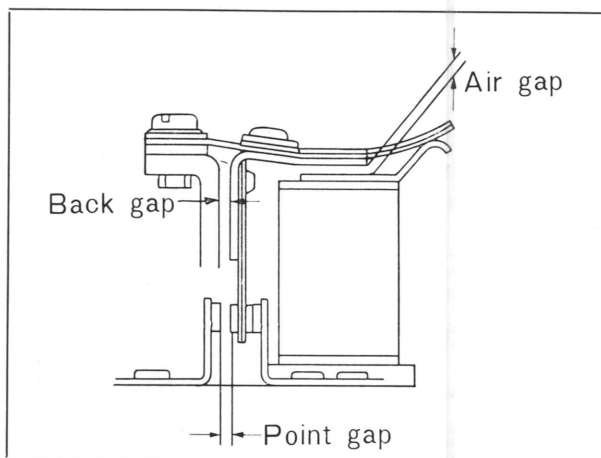

Fig. 5-20 Regulator gap

5-F. STARTING MOTOR

5-F-1. Checking the Starting Circuit

When the starting motor fails to operate or does not operate satisfactorily, check the following points before removing the starting motor.

1. Weak battery
2. Corroded or loose battery terminals
3. Loose starter motor terminals
4. Broken or loose wires of the starting circuit
5. Faulty ignition switch

5-F-2. Testing the Starting Motor

a. Free running test

1. Place the starting motor in a vise with soft jaws and connect a fully charged, 12 volt battery to the starting motor.
2. Connect an ammeter between the B terminal of the starting motor and the battery.
3. Operate the starting motor and take a reading. The current draw should be 70 amperes maximum at 3,600 rpm.

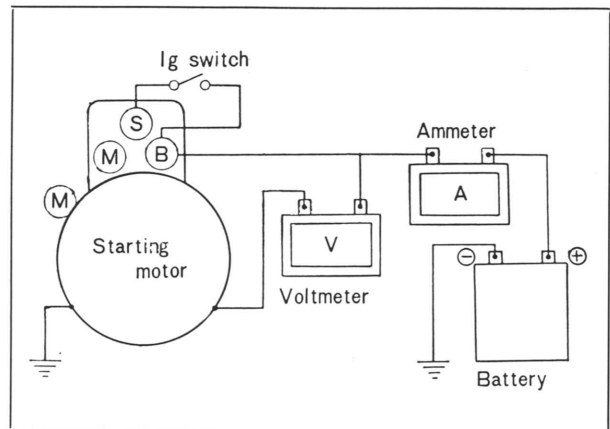

Fig. 5-21 Free running test

b. Lock resistance test

1. Install the starting motor on a test bench.
2. Test the lock resistance of the starting motor by following the instructions of the test equipment manufacturer.
3. With applied battery voltage adjusted to 6.0 volts, the current flow should be 60 amperes and the torque should be 2.7 m·kg (19.4 ft·lb).

If the starting motor does not perform to the above test requirements, repair it referring to the following list.

- 1) Starter rotates slowly with a large current at free running.
 - a) Worn, dirty or defective bearings
 - b) Short circuit of armature
 - c) Grounded armature and field coils
- 2) Starter does not rotate with a large current
 - a) Defective field circuit
 - b) Defective armature circuit
 - c) Burnt commutator
- 3) Low torque and low current flow. Low free running speed.
 - a) Breakage of the field circuit
 - b) Excessive internal resistance
- 4) Low torque. High free running speed.
 - a) Short circuit of the field coil

5-F-3. Disassembling the Starting Motor

1. Disconnect the field strap from the terminal on the magnet switch.
2. Remove the magnet switch attaching screws and remove the magnet switch, spring and washers from the center bracket.

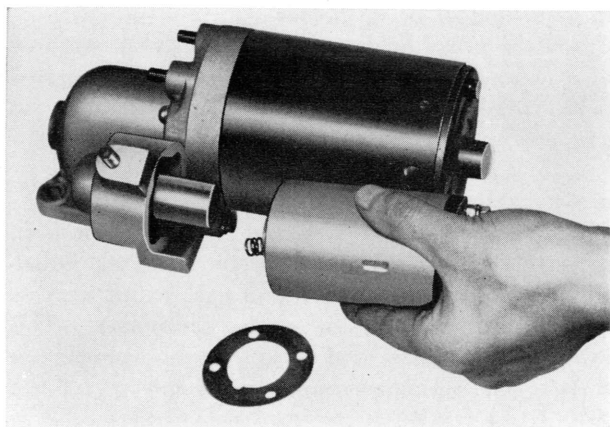

Fig. 5-22 Removing magnet switch

3. Remove the plunger from the driving lever.
4. Remove the through bolts and remove the rear bracket.

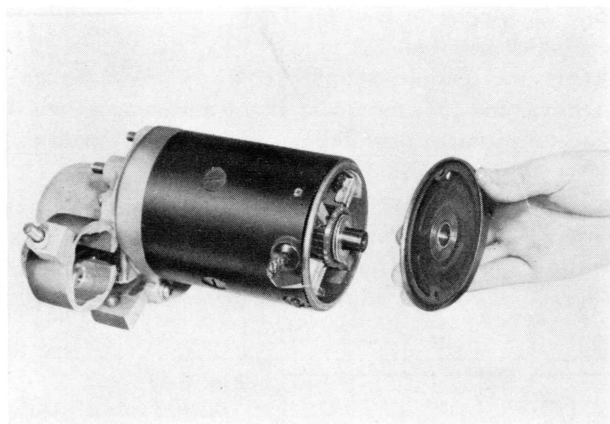

Fig. 5-23 Removing rear bracket

5. Remove the insulator and washer from the end of the armature shaft.
6. Loosening the field coil attaching screws, separate the field coil assembly from the center bracket.

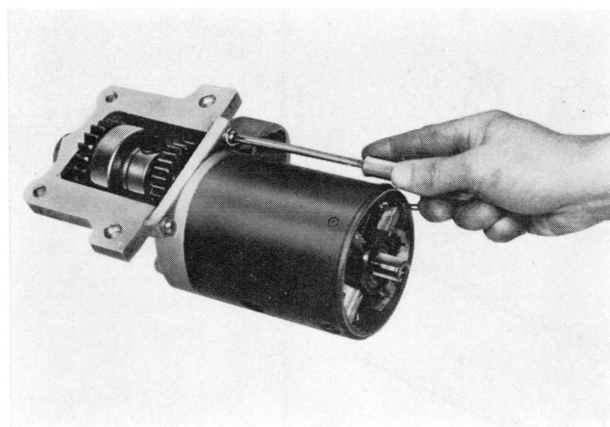

Fig. 5-24 Removing field coil

7. Remove the armature from the center bracket and remove the thrust washer.
8. Separate the front bracket and the center bracket.
9. Remove the driving lever, spring and spring seat.
10. Remove the over running clutch assembly from the front bracket.

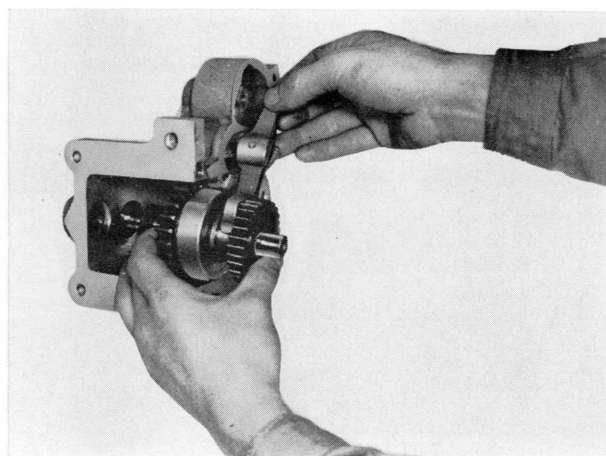

Fig. 5-25 Removing driving lever

5-F-4. Starting Motor Inspection

a. Checking of armature

Check the armature for both grounding and short circuit. To check for grounding, touch one prod of a tester to each segment and the other prod to the core or shaft. If there is current flow, the coil of the corresponding segment is grounded.

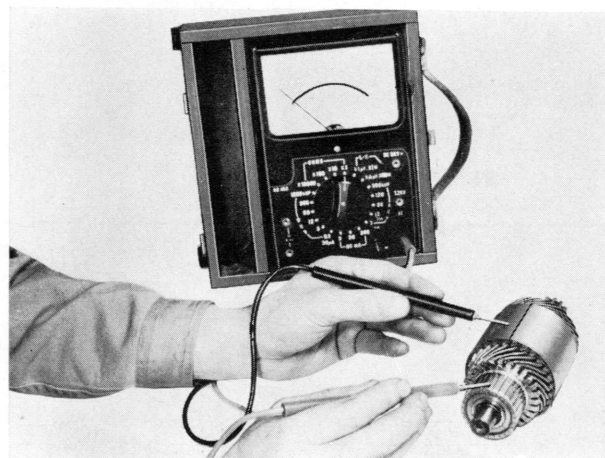

Fig. 5-26 Checking armature for ground

To check for short circuit, use a growler tester. Place the armature against the core of the tester, and hold a steel strip on the armature. Then, rotate the armature slowly by hand. In case of short in the coil, the steel strip will become magnetized and vibrate.

b. Checking of commutator

If the commutator is dirty, discolored or worn, clean it with emery paper and wash with clean solvent. After cleaning, undercut the mica between the segments to the depth of 0.5~0.8 mm. (0.020~0.031 in.) Refer to Fig. 5-27.

c. Checking of field coil

To test the field coil for ground with a tester, place one prod on the yoke or pole core and the other prod to the field terminal. In case of grounding, there will be current flow and the field coil must be repaired or replaced. Refer to Fig. 5-28.

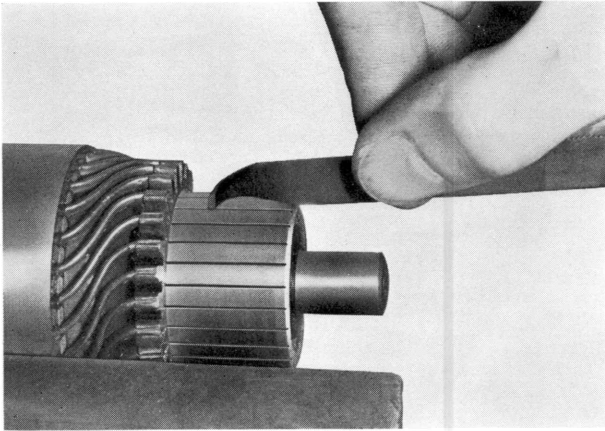

Fig. 5-27 Under cut

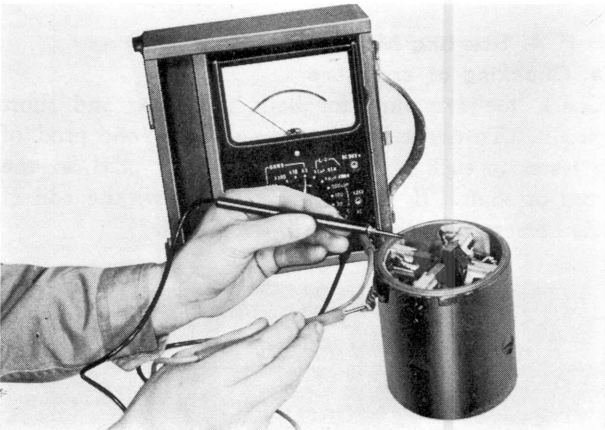

Fig. 5-28 Checking field coil

d. Checking of brush holder

Check the brush holder for ground. Touch one prod of a tester to the brush holder and the other prod to the frame. Current flow indicates grounding. In that case replace the holder.

e. Checking of brushes and brush springs

Check the brushes and replace if they are worn down more than one third of their original length. Otherwise, reduced spring tension will lead to an increase in the brush-commutator contact resistance. This lowers the torque and causes burnt commutator surface. The spring tension is 2.7 to 1.0 kg (1.5–2.2 lb). If the tension is too low, replace the springs.

f. Checking of bush

Check the clearance between the armature shaft and the bush. If it exceeds 0.2 mm. (0.008 in.), replace the bush.

5-F-5. Magnetic Switch Test

a. Pull-in coil test

Apply the specified voltage (12 V) between the (S) terminal and (M) terminal. If the magnetic switch is forcefully attracted, the pull-in coil is in good condition.

b. Holding coil test

Ground the (M) terminal to the magnetic switch body with a lead and impose the specified voltage (8 V) to terminal (S) to pull in the plunger. If the plunger

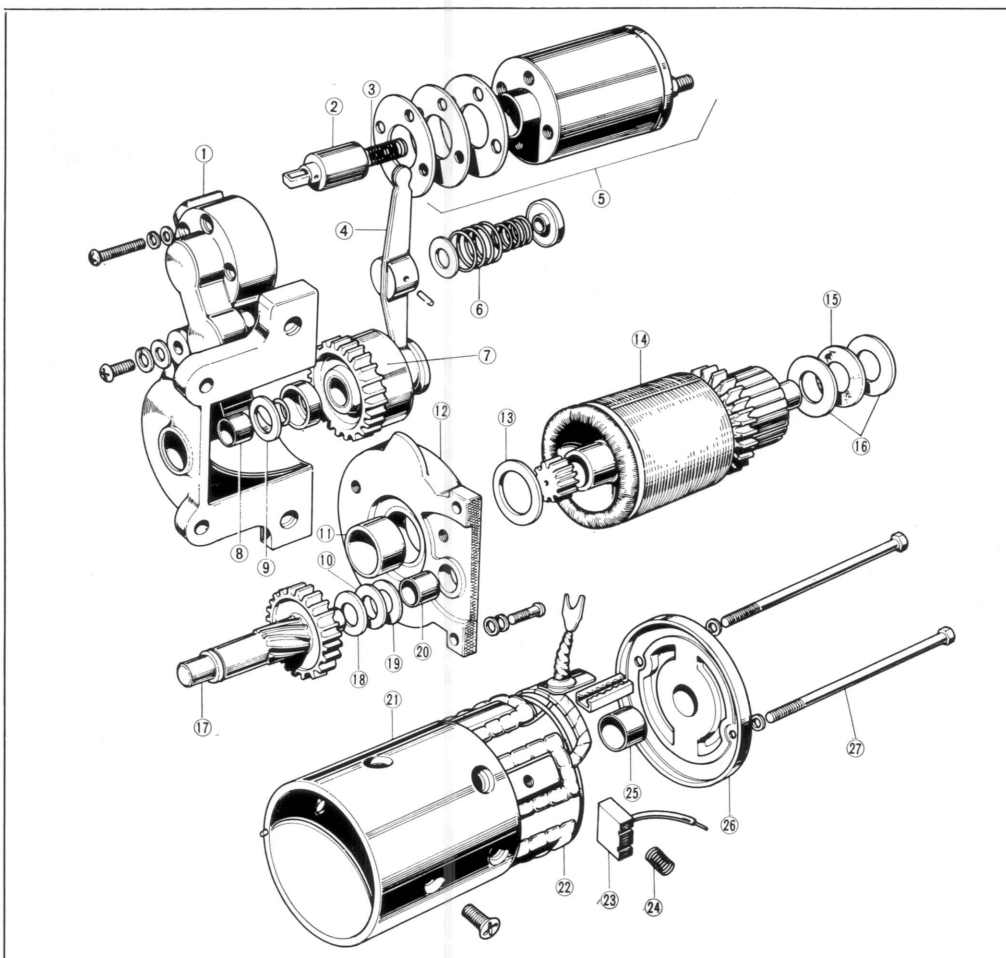

Fig. 5-29

Starting motor assembly

1. Front bracket
2. Plunger
3. Spring
4. Driving lever
5. Magnet switch ass'y
6. Driving lever spring
7. Over running clutch
8. Metal
9. Washer
10. Washer
11. Metal
12. Center bracket
13. Washer
14. Amature
15. Insulator
16. Washer
17. Pinion shaft
18. Washer
19. Washer
20. Metal
21. Yoke
22. Field coil
23. Brush
24. Brush spring
25. Metal
26. Rear bracket
27. Bolt

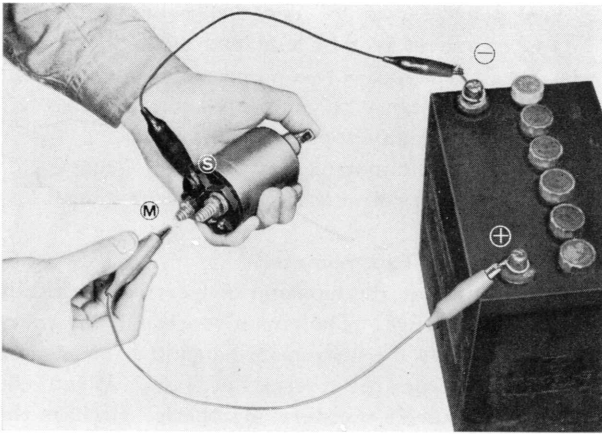

Fig. 5-30 Pull-in coil test

remains attracted after disconnecting the lead from the (M) terminal, the coil functions properly.

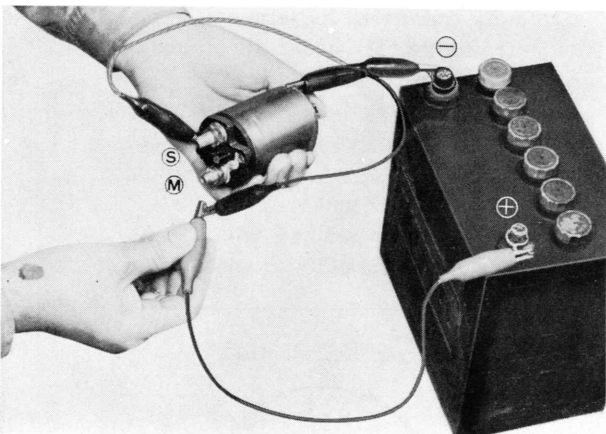

Fig. 5-31 Holding coil test

c. Return test

Push in the plunger by hand and apply the specified voltage (12 V) between the (M) terminal and the magnetic switch body. If the plunger is not attracted, there is no trouble.

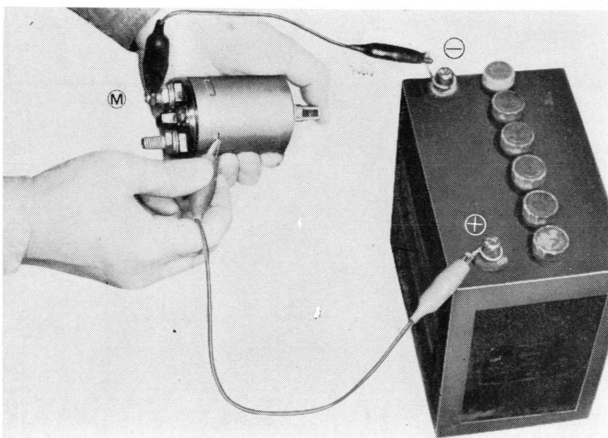

Fig. 5-32 Return test

5-F-6. Assembling the Starting Motor

To assemble the starting motor, reverse the procedure of Par. 5-F-3, noting the following points.

1. Adjust the armature shaft end play to 0.1~0.4 mm. (0.004~0.015 in.) with a thrust washer on the rear end of the shaft and pinion shaft end play to

0.1~0.3 mm. (0.004~0.012 in.) with a washer the end of the shaft.

2. When the magnetic switch is closed, the clearance between the pinion and stop collar should be 0.3~1.5 mm. (0.012~0.06 in.).

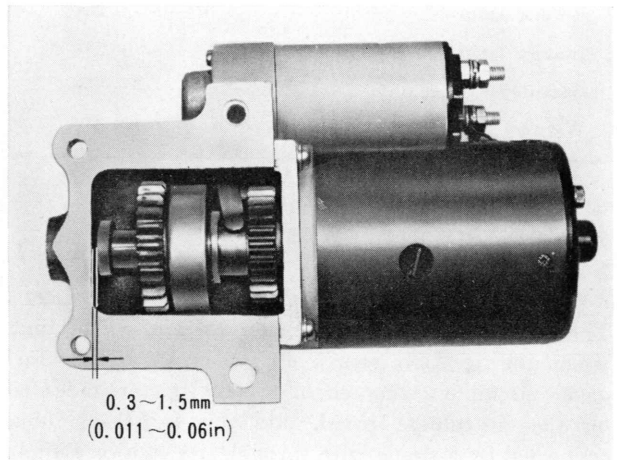

Fig. 5-33

5-G. LIGHTING SYSTEM

The wiring of the lighting systems is shown in the wiring diagrams. The wires in the various circuits are of different colors to aid when checking individual circuits.

5-G-1. Headlight Aim

Before adjusting the headlights, make sure that the tires are inflated uniformly to recommended pressure and the vehicle is on the level ground without load. To adjust the headlights, remove the head lamp frames and turn the three spring-loaded screws of the sealed beam unit the headlights are aimed properly. When the high beam is aimed 1.0 m. (39.37 in.) straight ahead, the center of the high intensity should be 12.3 mm. (0.48 in.) lower than the horizontal lamp center line, as shown in Fig. 5-34.

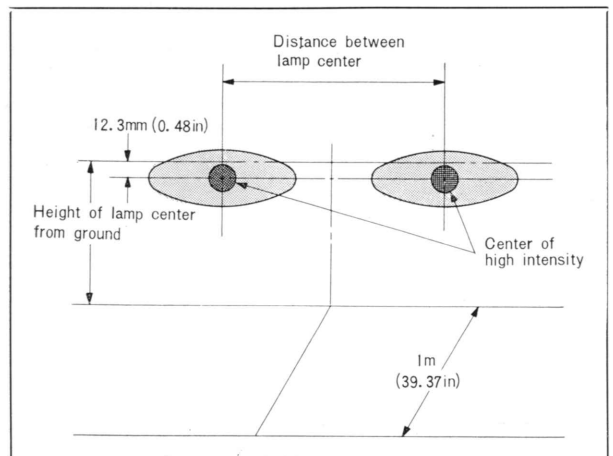

Fig. 5-34 Headlight aiming

5-G-2. Replacing the Bulbs

When replacing bulbs, conform to the following table.

Head lamp	50/40W
Side and front turn signal lamp	23/7W
Tail, stop and rear signal lamp.....	23/7W
Tail and stop lamp	23/7W
Reverse lamp	23W
Interior lamp	5W
Instrument panel illumination lamp.....	3W
Warning lamp	3W

5-H. INSTRUMENT PANEL

5-H-1. Fuel Gauge

R100 Coupé is equipped with an electric fuel gauge. The fuel gauge indicates the fuel quantity in the tank when the ignition switch is turned on. The fuel gauge circuit is composed of the fuel meter, mounted on the instrument panel, and the fuel tank unit, connected by a single wire through the ignition switch. Should the meter fail to register, check and repair the fuel meter circuit as follows:

- 1) Fuel gauge does not register with ignition "ON"
 - a) Defective panel unit
 - b) Faulty contact in IG terminal of meter gauge
 - c) Wiring to tank grounded
 - d) Meter gauge improperly grounded

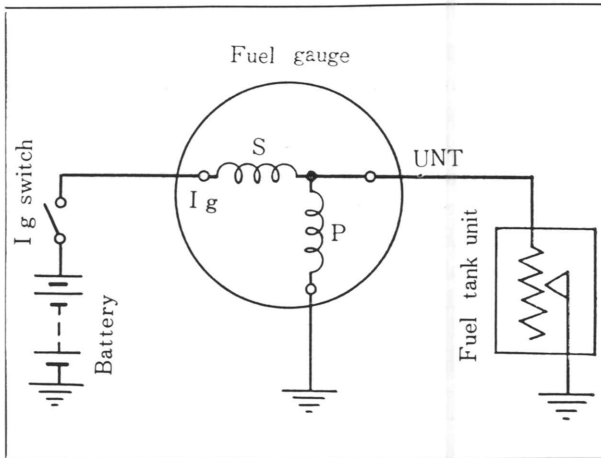

Fig. 5-35 Diagram of fuel gauge

- 2) Fuel gauge shows "F" under all conditions
 - a) Open circuit in tank unit and meter gauge
 - b) Break in wiring between tank unit and panel unit
- 3) Fuel gauge shows "E" under all conditions.
 - a) Loose or faulty contact of terminals
 - b) Short circuit in tank unit or meter gauge
 - c) Break in P coil and S coil of meter gauge

5-H-2. Water Thermometer

The cooling water thermometer is operated electrically like the fuel gauge. The circuit consists of the water thermometer on the instrument panel and the sending unit installed on the thermostat case. When the water thermometer registers improperly, check on the following points and refer to the wiring diagram for repair.

- 1) Pointer does not move when ignition switch is turned on.
 - a) Defective panel unit
 - b) Faulty contact in IG terminal
- 2) Pointer shows "H" under all conditions
 - a) Open circuit in sending unit
 - b) Break in wiring between both units
 - c) Loose or faulty contact in terminals
- 3) Pointer shows "C" under all conditions
 - a) Defective panel unit
 - b) Short circuit in sending unit
 - c) Panel unit improperly grounded

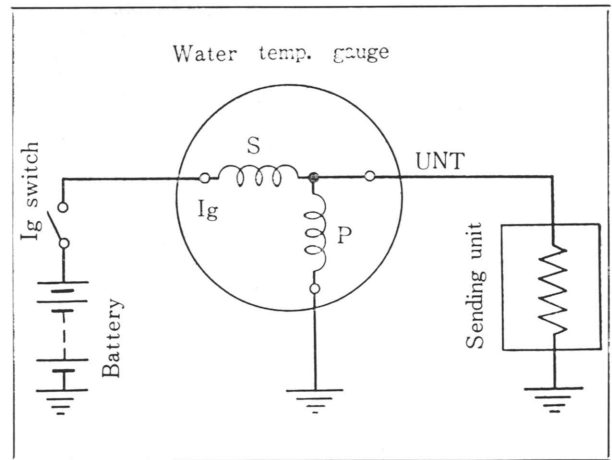
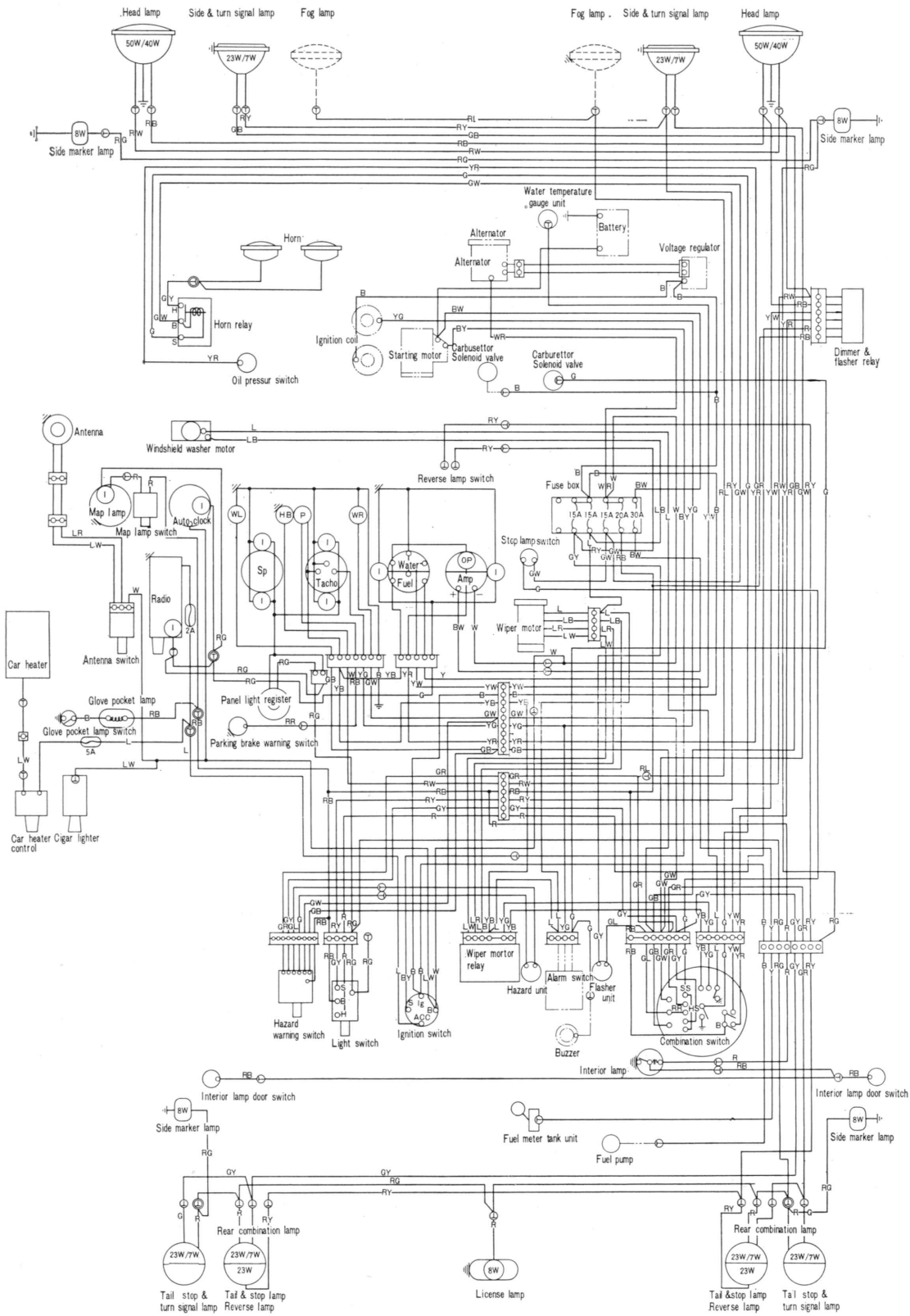

Fig. 5-36 Diagram of water temp. gauge



Abbreviations of wiring diagram		Wiring color code	Example
Amp = Ammeter	HB = High beam	R = Red	
Water = Thermometer	OP = Oil pressure lamp	G = Green	
Fuel = Fuel meter	SP = Speedometer	B = Black	
Tacho = Tacho meter	I = Illumination lamp	L = Yellow	
WL = Turn signal lamp (L)	P = Parking lamp	W = White	
WR = Turn signal lamp (R)			

Fig. 5-37 Wiring diagram

CLUTCH

6-A.	CLUTCH PEDAL ADJUSTMENT	6 : 1
6-B.	ADJUSTING THE RELEASE FORK...	6 : 1
6-C.	REMOVING THE CLUTCH	6 : 1
6-D.	CLUTCH INSPECTION	6 : 1
	6-D-1. Checking the Release Bearing...	6 : 1
	6-D-2. Checking the Pressure and Cover Assembly.....	6 : 1
	6-D-3. Checking the Clutch Disk.....	6 : 2
	6-D-4. Flywheel Inspection.....	6 : 2
	6-D-5. Ring Gear Replacement.....	6 : 2
	6-D-6. Inspecting the Needle Roller Bearing and Oil Seal...	6 : 2
6-E.	CLUTCH ASSEMBLY	6 : 2
6-F.	CLUTCH MASTER CYLINDER	6 : 2
	6-F-1. Removing the Clutch Master Cylinder.....	6 : 2
	6-F-2. Disassembling the Clutch Master Cylinder.....	6 : 3
	6-F-3. Checking the Clutch Master Cylinder.....	6 : 3
	6-F-4. Assembling the Clutch Master Cylinder.....	6 : 3
	6-F-5. Installing the Clutch Master Cylinder.....	6 : 3
6-G.	CLUTCH RELEASE CYLINDER.....	6 : 3
	6-G-1. Removing the Clutch Release Cylinder.....	6 : 3
	6-G-2. Checking the Clutch Release Cylinder.....	6 : 3
	6-G-3. Assembling the Clutch Release Cylinder.....	6 : 4
	6-G-4. Installing the Clutch Release Cylinder.....	6 : 4
6-H.	AIR BLEEDING	6 : 4

CLUTCH

The clutch is of the dry single disk type with a diaphragm spring. The clutch assembly consists of the clutch disk assembly, the clutch cover, pressure plate assembly, and the clutch release mechanism. The clutch operating mechanism is a hydraulic system identical to that for the brakes.

6-A. CLUTCH PEDAL ADJUSTMENT

The standard pedal height is 198 mm. (7.8 in.) from the toe board, as shown in Fig. 6-1. Adjustment is made by loosening the lock nut and turning the stopper bolt. After adjusting, tighten the lock nut. The free travel, before the by-pass port is closed by the piston cup, should be 5 ~ 10 mm. (0.20 ~ 0.40 in.). To adjust the free travel, loosen the lock nut and turn the push rod until proper adjustment is made.

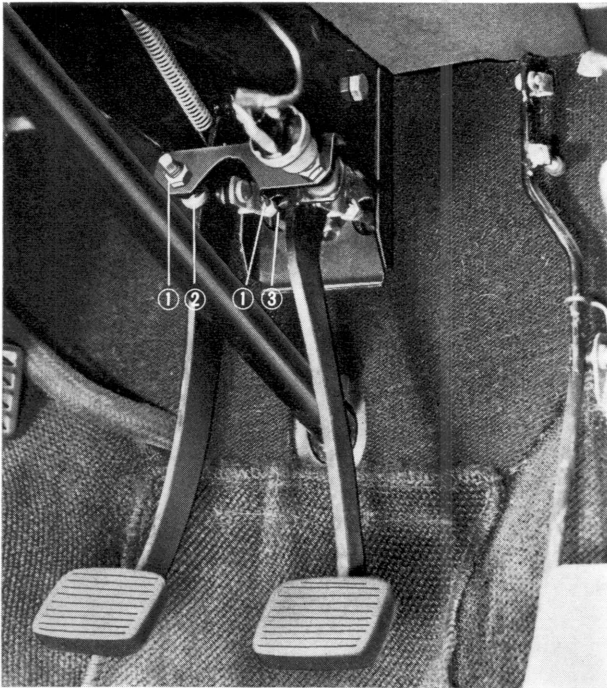

Fig. 6-1 Clutch pedal adjustment

- | | |
|-----------------|-------------|
| 1. Lock nut | 3. Push rod |
| 2. Stopper bolt | |

6-B. ADJUSTING THE RELEASE FORK

There should always be a safe clearance of 1.5 mm.

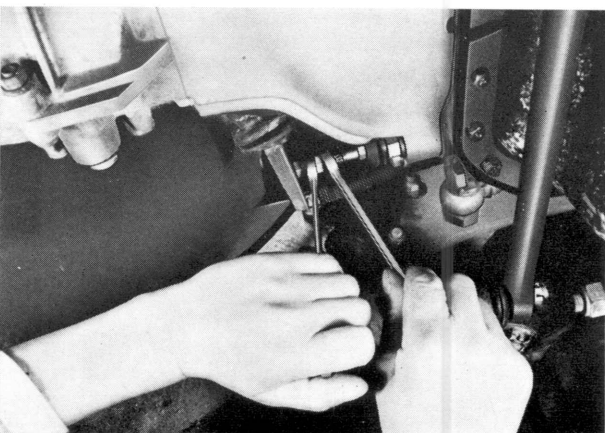

Fig. 6-2 Adjusting the release fork

(0.06 in.) between the release bearing and diaphragm spring. This clearance is essential to disengage the release bearing and to prevent unnecessary wear and possible slippage. This clearance is obtained when the free play of the release fork is adjusted to 3.0 mm. (0.12 in.). To adjust, remove the return spring, loosen the lock nut, and turn the adjuster until the correct play is obtained. After adjusting, secure the lock nut and hook the return spring.

6-C. REMOVING THE CLUTCH

To remove the clutch from the vehicle, proceed as follows:

1. Remove the transmission, as detailed in Par. 7-A.
2. Install the **ring gear brake** (49 0820 060).
3. Remove the bolts holding the clutch cover assembly to the flywheel, and remove clutch cover assembly and clutch disk.
4. Remove the return spring and the release bearing.
5. Pull the release fork outward by hand until the retaining spring of the fork releases itself from the pivot pin.

6-D. CLUTCH INSPECTION

6-D-1. Checking the Release Bearing

Check the release bearing by turning the bearing race by hand. Replace if the bearing feels rough or seems noisy when turning.

Examine the clutch housing carefully to be certain there are no burrs on the outer surface which pilots the release bearing.

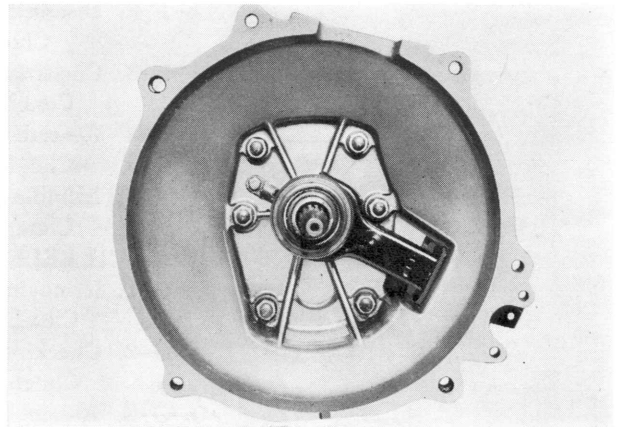

Fig. 6-3 Release bearing

Note: The release bearing is packed with a permanent lubricant. Therefore, the bearing must not be washed in gasoline or any other solvent.

6-D-2. Checking the Pressure and Cover Assembly

Check the pressure plate for warpage and scored surface. If defects are slight, correction can be made by lapping with compound or by machining on a lathe. If severely damaged, use new parts. Check the diaphragm spring and cover for wear or damage. If wear or damage is extensive, replace the diaphragm spring assembly.

6-D-3. Checking the Clutch Disk

Inspect the clutch disk for warpage with a dial indicator or a feeler gauge, as shown in Fig. 6-4. If it is more than 1.0 mm. (0.0394 in.), install a new one.

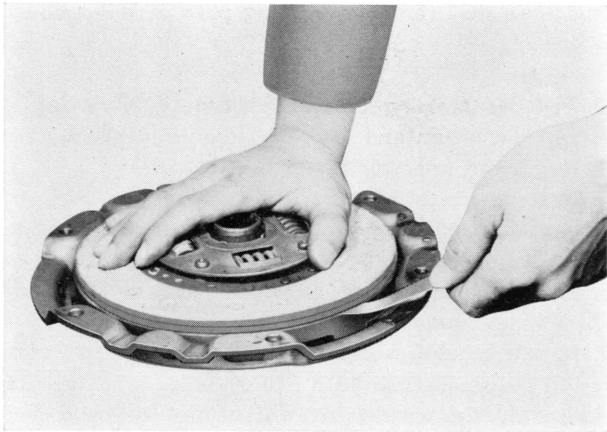

Fig. 6-4 Checking clutch disk

Replace excessively worn facing as it will cause slippage, or score plate and flywheel due to the projected heads of rivets. If oil is evident on the facing, clean or replace the disk and eliminate the cause of oil leakage. Make certain that the clutch disk slides easily on the main drive shaft without any play.

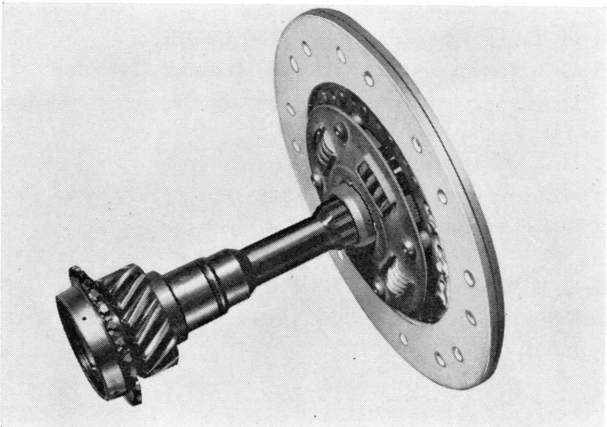

Fig. 6-5 Checking spline fit of clutch disk

6-D-4. Flywheel Inspection

Inspect the contact surface of the flywheel with the clutch facing for burnt or scored surface, or rivet grooves.

If damage is slight, it can be reconditioned by grinding on a lathe. If the damage is extensive, the flywheel should be replaced. Check the ring gear teeth and replace if the ring gear teeth are broken, cracked or seriously burred.

6-D-5. Ring Gear Replacement

1. Heat the old ring gear and remove it from the flywheel.
2. Heat the new ring gear evenly to 250~300°C (480~570°F).
3. Place the new ring gear on the cold flywheel, making sure that the chamfered side of the teeth faces the clutch side of the flywheel.
4. Allow the ring gear to cool slowly to shrink it

onto the flywheel.

6-D-6. Inspecting the Needle Roller Bearing and Oil Seal

Check the needle roller bearing and oil seal at the rear end of the eccentric shaft. Then insert the pilot part of the main drive shaft and check for smooth operation and proper clearance. If the bearing is loosen or runs rough, it should be replaced.

Check for wear and damage of the oil seal lip. If traces of oil leakage are found, replace the oil seal.

6-E. CLUTCH ASSEMBLY

1. Install the flywheel onto the rear end of the eccentric shaft through the key. Place the lockwasher in its place and install the lock nut.
2. Use a **ring gear brake** (49 0820 060) and tighten the lock nut to 45 m·kg (32 ft·lb).
3. Bend the lockwasher to prevent loosening.
4. Hold the clutch disk, pressure plate and cover assembly in mounting position. Then, insert a **clutch disk centering tool** (49 0813 310) through the spline of the disk and into the pilot bearing. If a tool is not available, use a spare main drive shaft.
5. Install the clutch cover attaching bolts after aligning the "O" marked hole on the clutch cover with reamer hole on the flywheel. In this case, use two reamer bolts for the holes marked by "O".

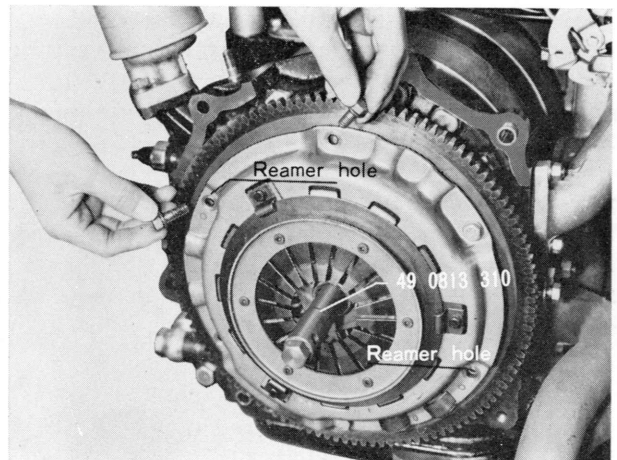

Fig. 6-6 Installing clutch disk and cover

6. Tighten the bolts to 2.0 m·kg (15 ft·lb).
7. Remove the centering tool and ring gear brake.
8. Apply grease to the pivot pin and drive the release fork inward so that the retaining spring of the fork fits to the pivot pin. Install the release bearing and hook the return spring. After installing, check to ensure that the release bearing slides smoothly back and forth on the retainer when operating the release fork.
9. Install the transmission. Care should be taken in order not to bend the clutch disk by allowing the transmission to hang.

6-F. CLUTCH MASTER CYLINDER

6-F-1. Removing the Clutch Master Cylinder

If it becomes necessary to remove the clutch master

cylinder for repair or overhaul, proceed as follows:

1. Disconnect the fluid pipe at the clutch master cylinder outlet.
2. Remove the nuts that attach the clutch master cylinder to the dash panel.

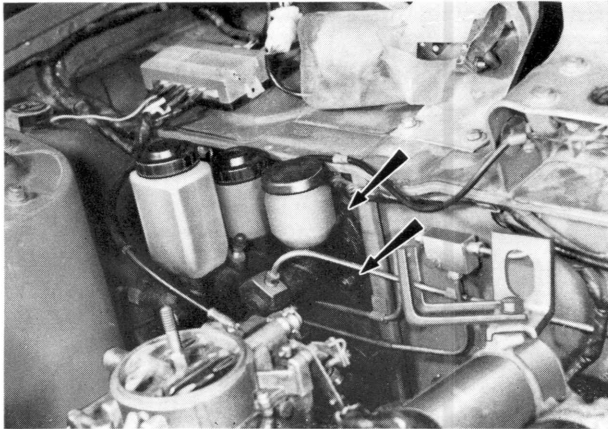

Fig. 6-7 Removing clutch master cylinder

3. Pull the clutch master cylinder straight out and away from the dash panel.

6-F-2. Disassembling the Clutch Master Cylinder

1. Clean the outside of the clutch master cylinder thoroughly and drain the brake fluid.
2. Remove the reservoir tank from the cylinder.
3. Remove the dust boot from the cylinder.
4. Remove the piston stop wire with a screwdriver and remove the stop washer.
5. Remove the piston, piston cup and return spring from the cylinder.

6-F-3. Checking the Clutch Master Cylinder

1. Wash the parts in clean alcohol or brake fluid. Never use gasoline or kerosene.
2. Check the piston cup and replace if they are damaged, worn, softened or swelled.

3. Examine the cylinder bore and piston for wear, roughness or scoring.
4. Check the clearance between the cylinder bore and the piston. If it is more than 0.15 mm. (0.006 in.), replace the cylinder or piston.
5. Ensure that the compensating port on the cylinder is open.

6-F-4. Assembling the Clutch Master Cylinder

1. Dip the piston and cups in clean brake fluid.
2. Install the reservoir tank.
3. Insert the return spring into the cylinder.
4. Install the primary piston cup so that the flat side of the cup faces the piston.
5. Fit the secondary cup onto the piston and install them in the cylinder.
6. Install the stop washer and stop wire.
7. Fill reservoir half with brake fluid and operate the piston with a screwdriver until the fluid is ejected at the outlet.
8. Install the dust boot to the cylinder.

6-F-5. Installing the Clutch Master Cylinder

1. Install the clutch master cylinder assembly onto the dash panel and tighten the nuts.
2. Connect the fluid pipe to the cylinder.
3. Fill with brake fluid and bleed the clutch hydraulic system, as described in Par. 6-H.

6-G. CLUTCH RELEASE CYLINDER

6-G-1. Removing the Clutch Release Cylinder

1. Disconnect the flexible pipe at the clutch release cylinder.
2. Unhook the release fork return spring.
3. Remove the bolts attaching the cylinder to the clutch housing. Remove the release cylinder.

6-G-2. Checking the Clutch Release Cylinder

- Refer to Par. 6-F-3 and inspect the clutch release cylinder.

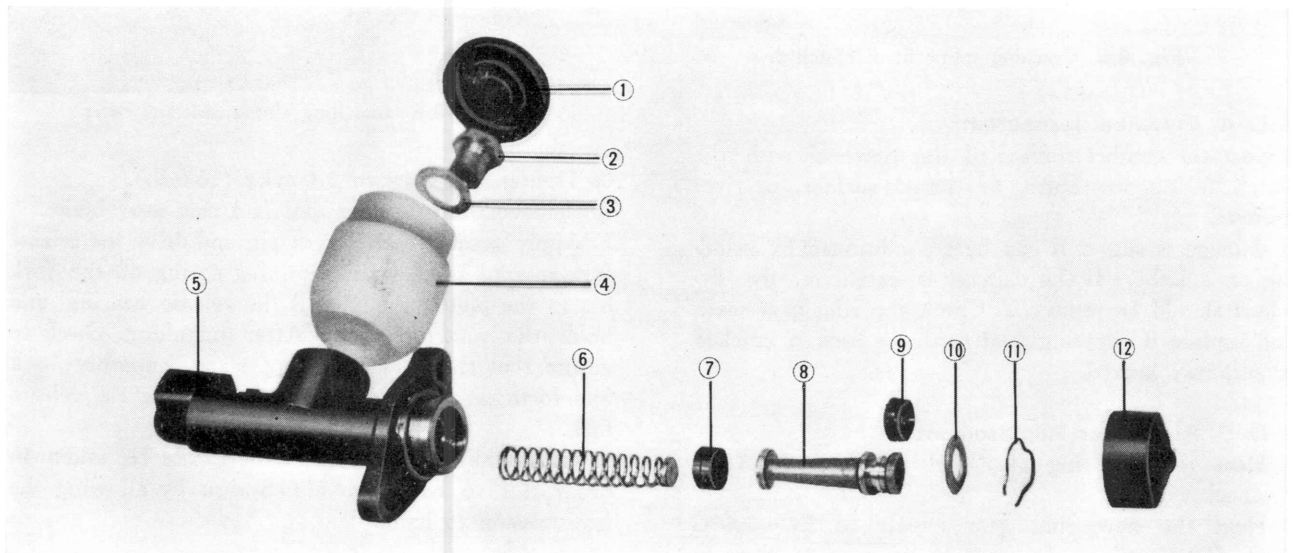

Fig. 6-8 Clutch master cylinder

- | | | | |
|-------------------|-------------------|------------------|-----------------|
| 1. Cap | 4. Reservoir tank | 7. Secondary cup | 10. Stop washer |
| 2. Connector bolt | 5. Cylinder | 8. Piston | 11. Stop wire |
| 3. Washer | 6. Return spring | 9. Piston cup | 12. Dust boot |

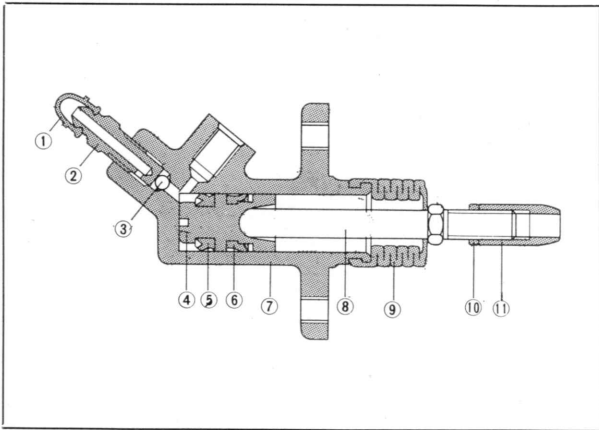

Fig. 6-9 Clutch release cylinder

- | | |
|------------------|--------------|
| 1. Cap | 7. Cylinder |
| 2. Valve | 8. Rod |
| 3. Steel ball | 9. Boot |
| 4. Piston | 10. Lock nut |
| 5. Primary cup | 11. Adjuster |
| 6. Secondary cup | |

6-G-3. Assembling the Clutch Release Cylinder

1. Fit the cups to the piston and install them in the cylinder.
2. Install the dust boot on the end of the cylinder.
3. Install the steel ball and bleeder into the bleeder hole.
4. Install the clutch release rod.

6-G-4. Installing the Clutch Release Cylinder

1. Install the clutch release cylinder assembly to the clutch housing with two bolts.
2. Connect the flexible pipe.
3. Fill the reservoir of the master cylinder with brake fluid and bleed the system, as described in Par. 6-H.
4. Adjust the free play of the release fork, as described in Par. 6-B.
5. Hook the return spring.

6-H. AIR BLEEDING

The clutch hydraulic system must be bled whenever a fluid line has been disconnected or air enters the system. To bleed the clutch system, remove the rubber cap from the bleeder valve and attach the bleeder tube and fixture of the bleeder screw. Place the end of the tube in a glass jar and submerge in brake fluid. Open the bleeder valve. Depress the brake pedal and allow it to return slowly. Continue this pumping action and watch the flow of fluid in the jar. When air bubbles cease to appear, close the bleeder valve. During bleeding the reservoir of the master cylinder must be kept filled with fluid at least 3/4 of its capacity. After the bleeding operation, remove the tube, fit the cap on the bleeder valve, fill the reservoir and fit the filler cap.



Fig. 6-10 Air bleeding

SPECIAL TOOLS

- | | |
|-------------|----------------------------|
| 49 0820 060 | Ring gear brake |
| 49 0813 310 | Clutch disk centering tool |

TRANSMISSION

7-A.	TRANSMISSION REMOVAL.....	7 : 3
7-B.	DISASSEMBLING THE TRANSMISSION.....	7 : 3
7-B-1.	Disassembling the Main Shaft...	7 : 4
7-B-2.	Disassembling the Main Drive Shaft.....	7 : 4
7-B-3.	Disassembling the Counter Shaft.....	7 : 4
7-C.	TRANSMISSION INSPECTION.....	7 : 4
7-C-1.	Inspection of Transmission Case.....	7 : 4
7-C-2.	Checking the Bearings	7 : 4
7-C-3.	Checking the Gears.....	7 : 4
7-C-4.	Checking the Synchronizer Mechanism.....	7 : 4
7-C-5.	Checking Run-Out of Main Shaft.....	7 : 5
7-C-6.	Fitting the Gear Bushes, Clutch hub and Main Shaft...	7 : 5
7-C-7.	Fitting the Counter Shaft and Gear.....	7 : 5
7-C-8.	Fitting Reverse Idle Gear and Shaft.....	7 : 5
7-D.	TRANSMISSION ASSEMBLY	7 : 5
7-D-1.	Installing the Reverse Idle Gear.....	7 : 5
7-D-2.	Installing the Shift Forks and Rods	7 : 5
7-D-3.	Installing the Main Shaft and Main Drive Shaft Assembly ...	7 : 6
7-D-4.	Installing the Counter Shaft Assembly	7 : 6
7-D-5.	Fitting the Transmission Case...	7 : 6
7-D-6.	Installing the Clutch Housing...	7 : 7
7-D-7.	Installing the Transmission Extension.....	7 : 7
7-D-8.	Installing the Reverse Lamp Switch.....	7 : 7
7-D-9.	Installing the Speedometer Driven Gear Assembly	7 : 7
7-D-10.	Installing the Change Control Case	7 : 7
7-D-11.	Connecting the Reverse Lamp Wiring.....	7 : 8
7-E.	INSTALLING THE TRANSMISSION...	7 : 8

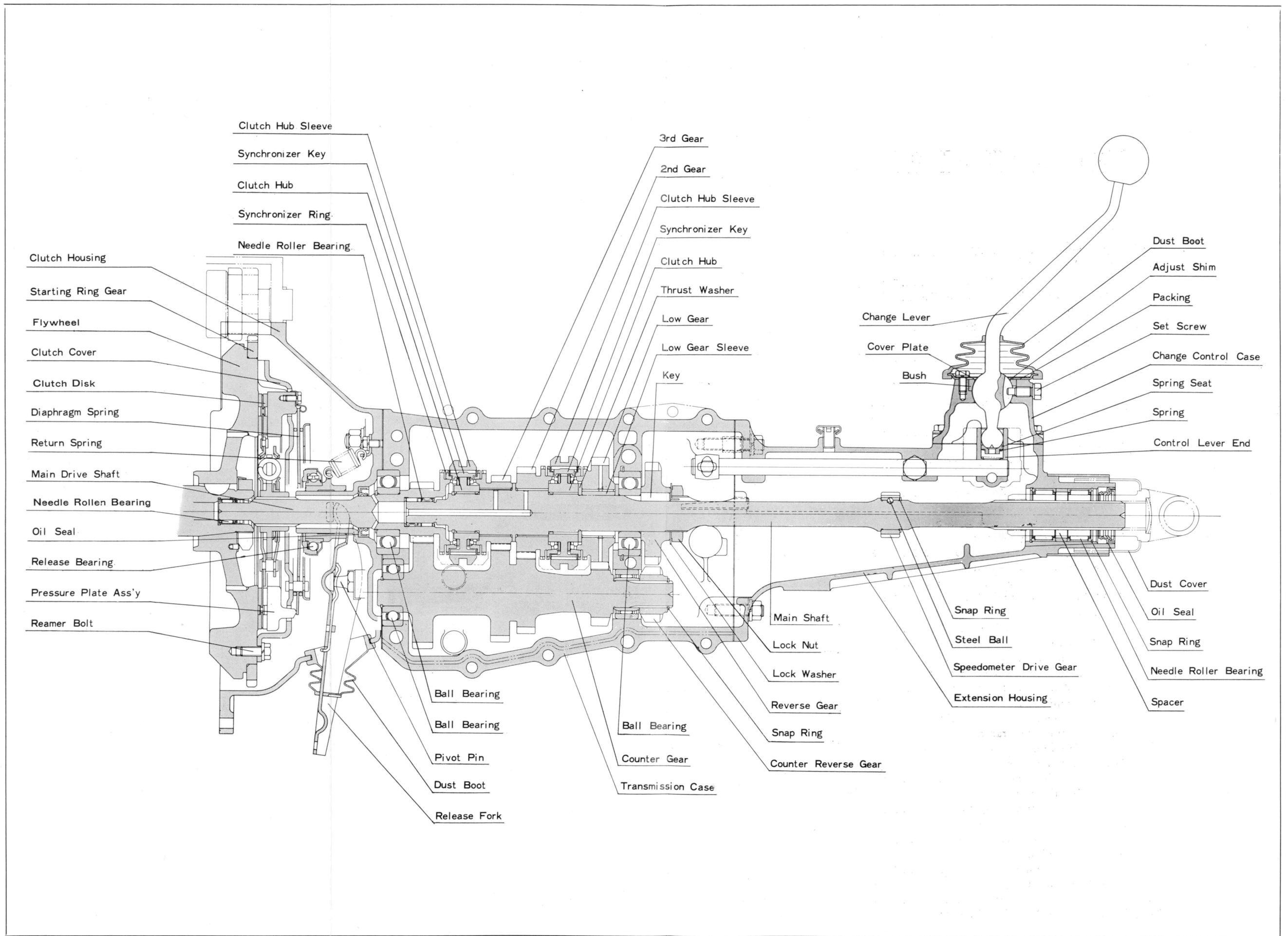

Fig. 7-1 Clutch and transmission

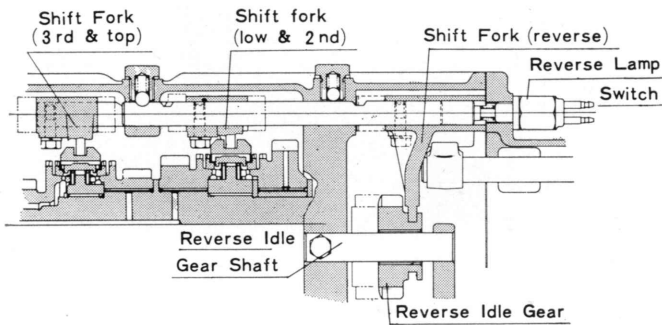
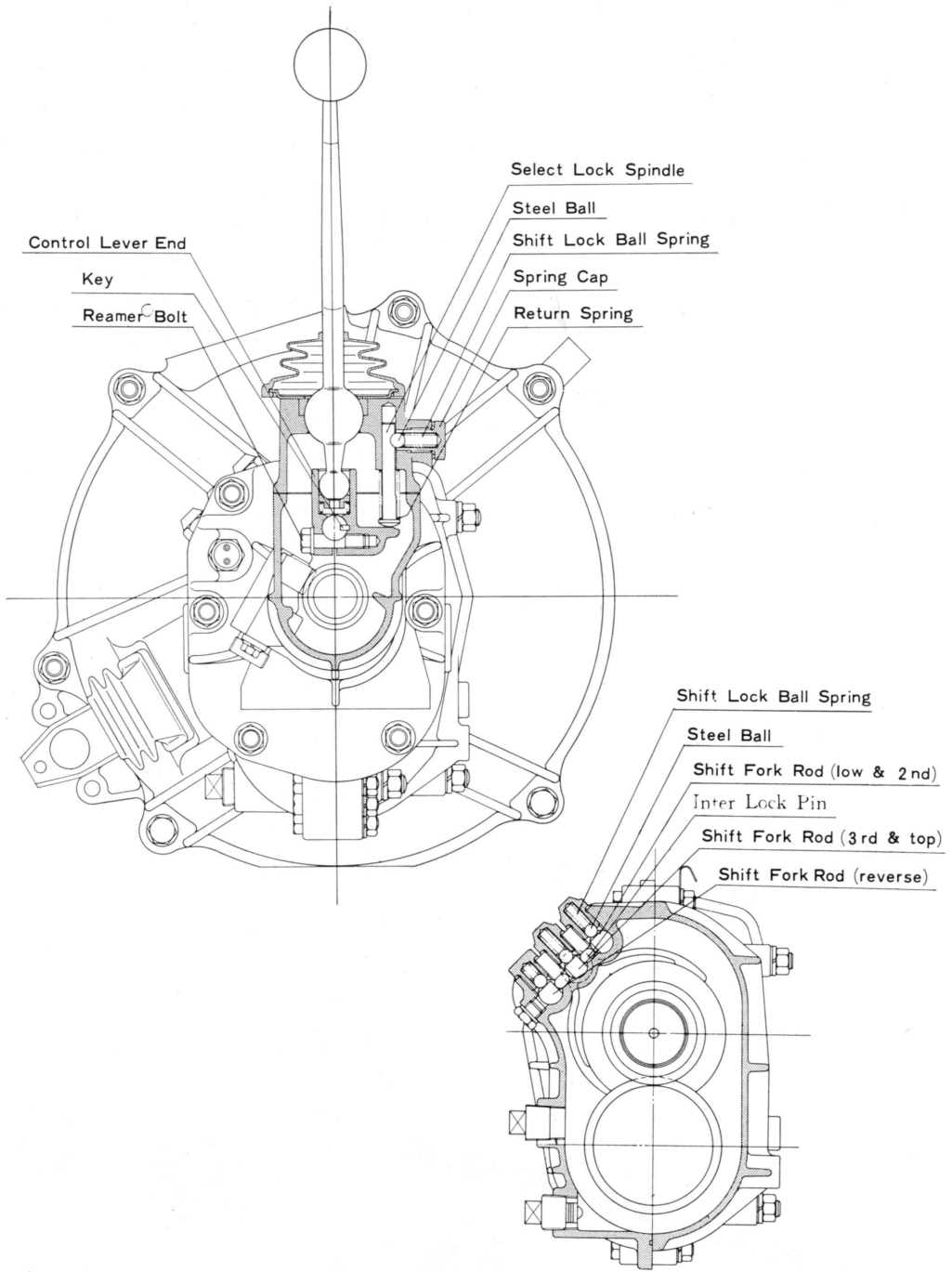

Fig. 7-2 Transmission

TRANSMISSION

R100 Coupé is equipped with a four-speed manual transmission of the synchromesh type with helical gears to provide silent operation. Gear shifting is of the direct control floor-shift type.

The transmission gear ratio is as follows:

Gear	Gear Ratio
First	3.737
Second	2.202
Third	1.435
Top	1.000
Reverse	4.024

7-A. REMOVING THE TRANSMISSION

When removing only the transmission from the vehicle, proceed as follows:

1. Disconnect the earth wire of the battery.
2. Remove the gear shift lever dust boots. Loosen the attaching bolts on the cover plate and remove the dust boot, cover plate and bush together with the shift lever from the transmission housing.
3. Disconnect the wirings of the starting motor and the reverse lamp switch and then remove the starting motor.
4. Remove the drain plug and drain the transmission oil. Clean the drain plug and reinstall after draining.
5. Disconnect the speedometer cable from the speedometer driven gear.
6. Remove the release fork return spring. Loosen the nuts and remove the clutch release cylinder with the push rod from the clutch housing.
7. Disconnect the exhaust pipe from the exhaust manifold by loosening the nuts.
8. Disconnect the propeller shaft from the trans-

mission. (Refer 8-A.)

9. Support the transmission with a jack and a block of wood and remove the nuts holding the supporter on to the side frame member.

10. Remove the bolts holding the transmission on to the clutch housing.

11. Move the transmission toward the rear so as to remove the main drive shaft from the clutch disk. Lower the jack and remove the transmission from the vehicle.

7-B. DISASSEMBLING THE TRANSMISSION

Wash and clean the outer surface of the transmission before disassembly.

1. Remove the speedometer driven gear from the extension housing after removing the lock plate.
2. Remove the control case assembly from the extension housing.
3. Remove the nuts that attach the extension housing to the case. Slide the extension housing off the main shaft, with the control lever end held down to the left as far as possible.
4. Remove the nuts attaching the clutch housing to the case and remove the clutch housing.
5. Separate the right half of the case from the left half by removing the attaching bolts and nuts.
6. Remove the counter shaft and gear assembly.
7. Remove the main shaft and main drive shaft assembly.
8. Remove the shift fork rod locking balls and springs, and remove the interlock pins. Loosen the shift fork set bolt and remove the shift fork and rod from the case.
9. Remove the reverse idle gear and shaft after removing the set screw.

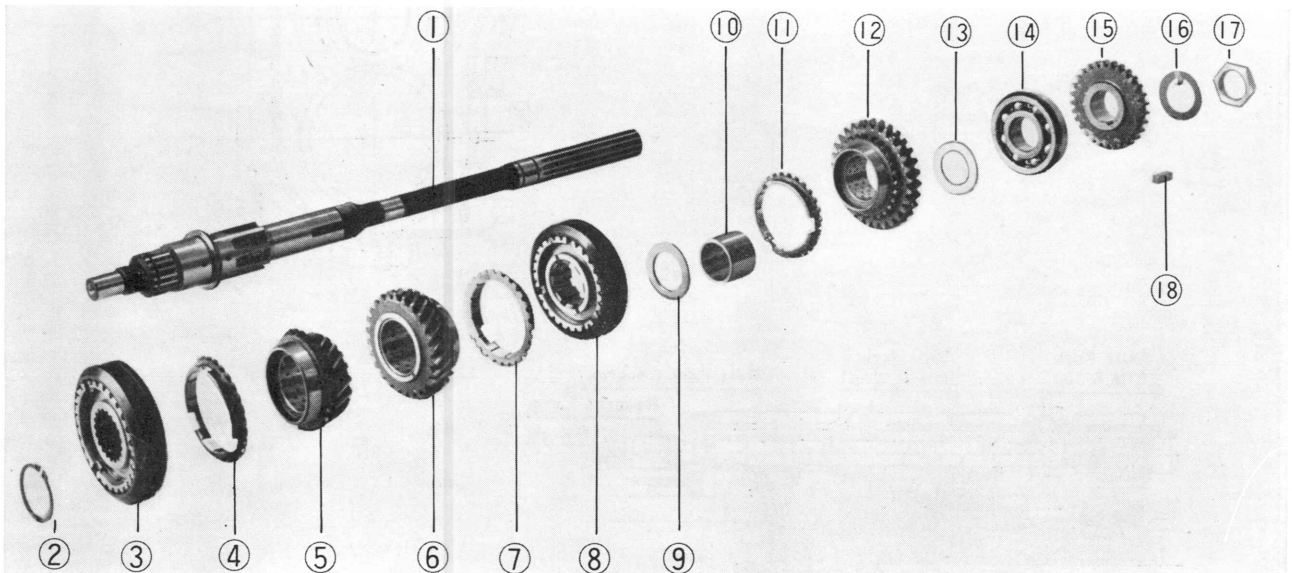

Fig. 7-3 Main shaft assembly

- | | | |
|---------------------------------|---------------------------------|-------------------|
| 1. Main shaft | 7. Synchronizer ring (2nd) | 13. Thrust washer |
| 2. Snap ring | 8. Clutch hub ass'y (low & 2nd) | 14. Ball bearing |
| 3. Clutch hub ass'y (3rd & top) | 9. Thrust washer | 15. Reverse gear |
| 4. Synchronizer ring (3rd) | 10. Low gear sleeve | 16. Lock washer |
| 5. Third gear | 11. Synchronizer ring (low) | 17. Lock nut |
| 6. Second gear | 12. Low gear | 18. Key |

7-B-1. Disassembling the Main Shaft

1. Using a suitable plier, remove the snap ring on the rear side of the speedometer drive gear.
2. Slide the speedometer drive gear off the main shaft, and remove the steel ball.
3. Mount the main shaft assembly on the **main shaft holder** (49 0223 331), as shown in Fig. 7-4, and loosen the reverse gear lock nut.



Fig. 7-4 Loosening lock nut

4. Remove the reverse gear and the bearing.
5. Remove the thrust washer, low gear and sleeve assembly, synchronizer ring, thrust washer, low and second clutch hub assembly, synchronizer ring, and the second gear in that order.
6. Remove the clip on the front end of the main shaft. Remove the third and top clutch hub assembly, synchronizer ring and third gear.

7-B-2. Disassembling the Main Drive Shaft

1. Remove the snap ring from the front of the main drive shaft.
2. Remove the bearing with a suitable puller.

7-B-3. Disassembling the Counter Shaft

1. Remove the snap rings from both ends of the counter shaft.
2. Remove the ball bearing from the front, and the reverse gear and needle roller bearing from the rear of the counter shaft.

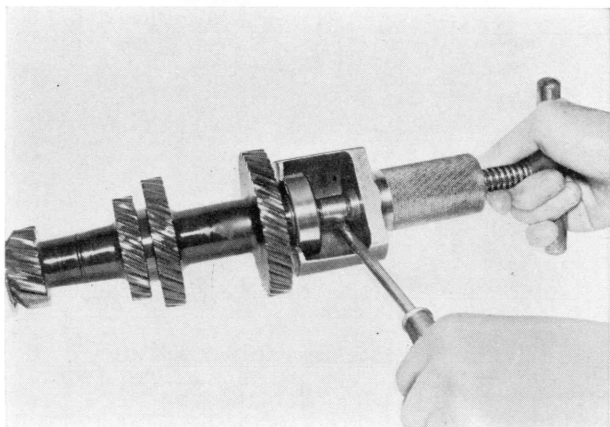

Fig. 7-5 Removing ball bearing

7-C. INSPECTING THE TRANSMISSION

7-C-1. Inspecting the Transmission Case

Clean the transmission case thoroughly with a suitable solvent, and dry with compressed air. Inspect the case for cracks and the machined mating surfaces for burrs, nicks or any damage.

7-C-2. Checking the Bearings

Check each of the bearings and replace those which are excessively worn or do not rotate smoothly. Excessive wear of the bearings will increase backlash which will result in noises and may cause gears to work off while running.

7-C-3. Checking the Gears

Inspect the teeth of each gear. If excessively worn, broken or chipped, replace with new gears. Excessive wear of the gears causes increase of backlash, which results in producing noises or may cause the gear to work off while running.

7-C-4. Checking the Synchronizer Mechanism

1. To check the contact between the inner surface of the synchronizer ring and the cone surface of the gear, apply a thin coat of Prussian Blue on the cone surface of the gear and fit it on the ring. The contact should be even and uniform over the contacting surface. If the contact is one-sided or spotty, this must be corrected. If the amount of correction necessary is small, this may be done by lapping the surfaces together lightly with compound. If the defects are excessive, replace the synchronizer ring or the gear.

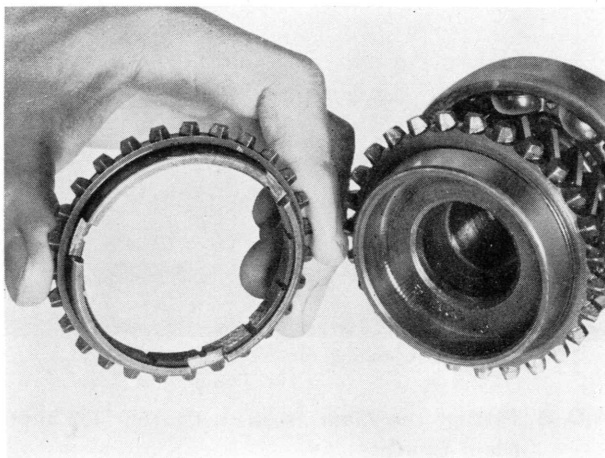

Fig. 7-6 Inspecting synchronizer ring

2. Although the contact between the inner surface of the synchronizer ring and the gear cone is satisfactory, if extensive general wear has caused the groove on the inner surface of the ring to disappear, the oil film will not be sufficiently cleared resulting in inferior synchronization. The inner surface of the ring should therefore be checked and if the wear is excessive, the ring should be replaced.

3. Check the synchronizer key, the inner surface of the clutch sleeve, and the key groove on the clutch hub for wear. If wear is excessive, it will cause difficulties in maintaining the neutral position of the clutch sleeve or will cause inferior functioning of the synchronizer ring and make shifting difficult.

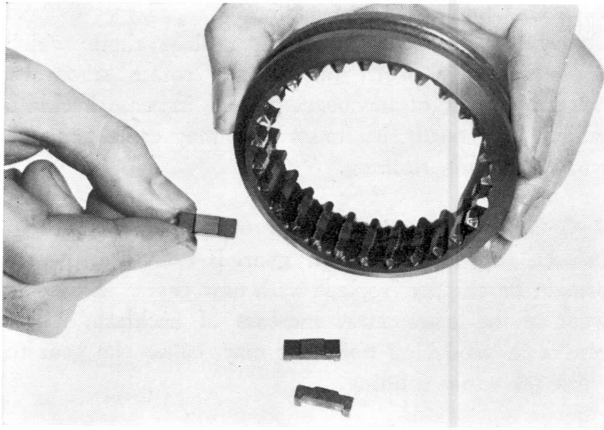

Fig. 7-7 Checking clutch sleeve and key

4. Check the key spring tension. Decreased tension or damaged key springs will result in uneven pressure against the three keys and will cause improper functioning of the keys and inferior synchronization.

7-C-5. Checking the Run-Out on the Main Shaft

Check the run-out on the main shaft and if the deflection is excessive, correct it by using a press. The standard reading on the dial indicator for run-out should be less than 0.03 mm. (0.0012 in.).

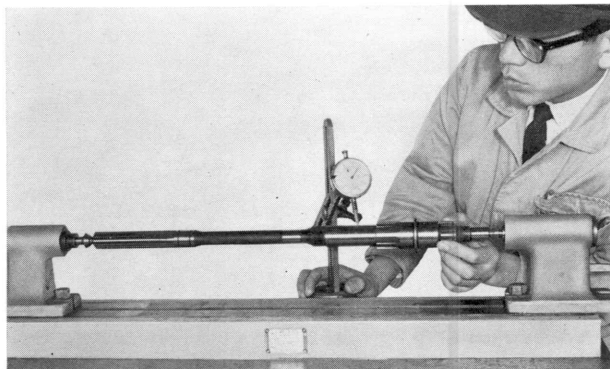

Fig. 7-8 Checking run-out of main shaft

7-C-6. Fitting the Gear Bushes, Clutch Hub and Main Shaft

Check the fitting clearances between the main shaft and the gear bushes. If any of the clearances exceeds 0.15 mm. (0.0059 in.), replace the shaft or the bush. The standard fitting clearance is 0.022~0.058 mm. (0.0009 ~ 0.0022 in.). Check the play between the main shaft and the clutch hub in the direction of spline rotation and if the play exceeds 0.25 mm. (0.0098 in.), replace the clutch hub or the main shaft. The standard play is 0.030 ~ 0.108 mm (0.0012 ~ 0.0042 in.) for low and second, and 0.040 ~ 0.134 mm. (0.0016 ~ 0.0053 in.) for third and top.

7-C-7. Fitting the Counter Shaft and Gear

The standard fitting clearance between the counter shaft and the reverse gear in the direction of the spline rotation is 0.030 ~ 0.108 mm. (0.0012 ~ 0.0042 in.). If this clearance exceeds 0.25 mm. (0.0098 in.), replace the shaft of the gear.

7-C-8. Fitting the Reverse Idle Gear and Shaft

Check the fitting clearance between the reverse idle gear bush and shaft. If the clearance exceeds 0.15 mm. (0.0059 in.), replace the bush or the shaft. The standard fitting clearance is 0.022 ~ 0.058 mm. (0.0009 to 0.0023 in.). Excessive clearance due to wear will cause an increase in gear backlash resulting in uneven wear of the gear and noise.

7-D. ASSEMBLING THE TRANSMISSION

7-D-1. Installing the Reverse Idle Gear

Install the reverse idle gear and the shaft to the transmission case and secure the shaft with the set screw.

7-D-2. Installing the Shift Forks and Rods

Install the shift forks and the shift fork rods for the low & second, the third & top, and the reverse, in this order commencing from the bottom as shown in Fig. 7-9.

1. First, fit the adjusting spacer on the rod to prevent over shift and then install the shift fork and rod for the low & second to the case. Install the two **shift fork rod guides** (49 0187 441A) to the case and after aligning the holes with the **interlock pin guide** (49 0187 451), insert the interlock pin. Next, remove the shift fork rod guide, and after installing the reverse shift fork to the groove on the idle gear, fit the adjust spacer to the rod and install the shift fork and rod for the third & top gear to the case. In the same way, after inserting the intelock pin, fit adjust the spacer between the case and the fork and install the rod for the reverse to the case.

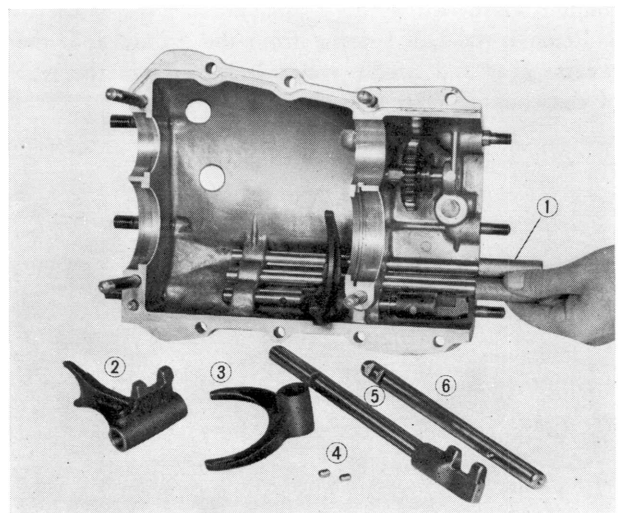

Fig. 7-9 Installing shift fork and rod

- | | |
|---------------------------|-------------------------------|
| 1. Shift fork rod guide | 4. Interlock pin |
| 2. Shift fork (Reverse) | 5. Shift fork rod (3rd & Top) |
| 3. Shift fork (3rd & Top) | 6. Shift fork rod (Reverse) |

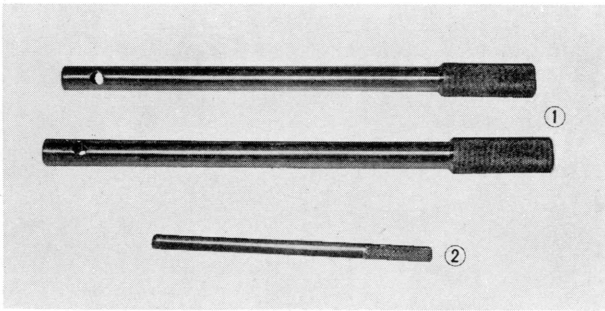

Fig. 7-10

1. Shift fork rod guide 2. Interlock pin guide

2. Install the plug with packing to the interlock pin guide hole.
3. Properly secure each of the shift forks on the rods with set bolts. Tighten the bolts to a torque of 1.0 m-kg (7.2 ft-lb).

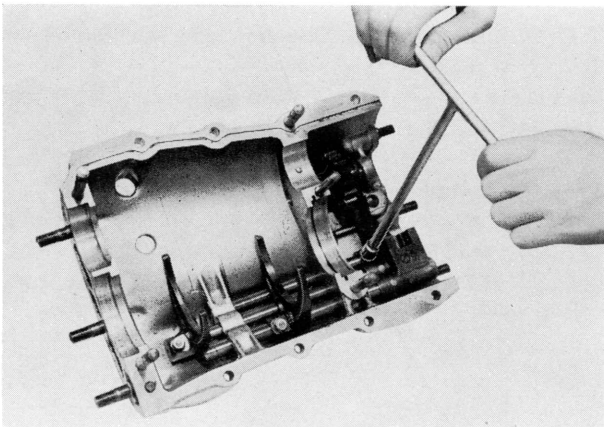

Fig. 7-11 Securing shift fork

4. Install the locking ball and spring to the groove on the shift fork through the case and fit the spring cap with packing to the case. The set spring pressure is 4.25 kg (9.37 lb).

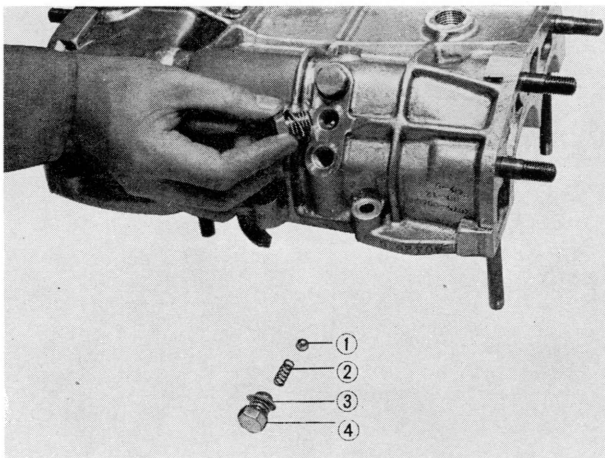

Fig. 7-12 Installing locking ball and spring

1. Locking ball
2. Spring
3. Packing
4. Spring cap

7-D-3. Installing the Main Shaft and Main Drive Shaft Assembly

Fit the needle roller bearing onto the front portion of the main shaft and connect the main shaft and

main drive shaft. Install the main shaft and main drive shaft assembly into the transmission case so that the groove of the clutch sleeve aligns with the shift fork, as shown in Fig. 7-13. Move the shift fork rod and check the shifting.

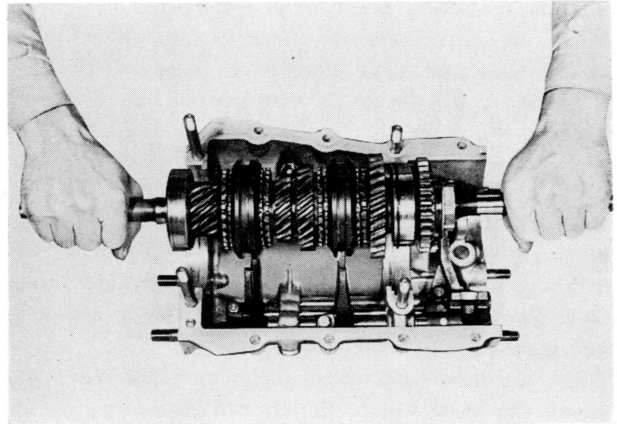

Fig. 7-13 Installing main shaft assembly

7-D-4. Installing the Counter Shaft Assembly

Install the counter shaft assembly meshing with each gear into the transmission case.

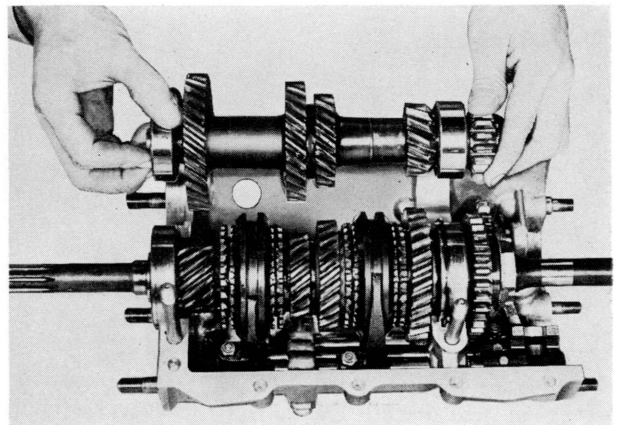

Fig. 7-14 Installing counter shaft assembly

7-D-5. Fitting the Transmission Case

Apply a thin coat of sealing agent on the contact surface of the left half of the transmission case. After aligning the knock pin, fit the right half of the case and tighten the nuts and bolts. A groove is provided

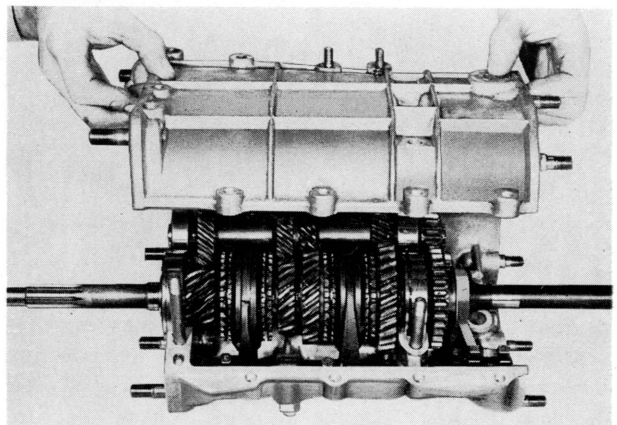

Fig. 7-15 Fitting transmission case

on the contact surface on the left half of the case for the purpose of preventing oil leakages by increasing surface pressure and improving the contact. The standard torque for 8 mm. bolts is 2.5 m·kg (18.0 ft·lb) and for 10 mm. bolts, 4.0 m·kg (29 ft·lb).

7-D-6. Installing the Clutch Housing

Place the gasket on the front surface of the transmission case and install the clutch housing. Be sure that the oil seal inside the housing is not damaged. Tighten the 6 nuts.

7-D-7. Installing the Transmission Extension

1. Install the oil seal on the rear side of the extension by using an installer.
 2. Insert the control lever through the 2 guide holes from the front side of the extension, align the key, and install the control lever end.
- Align the holes and install the reamer bolt and then secure the lever end to the control lever.

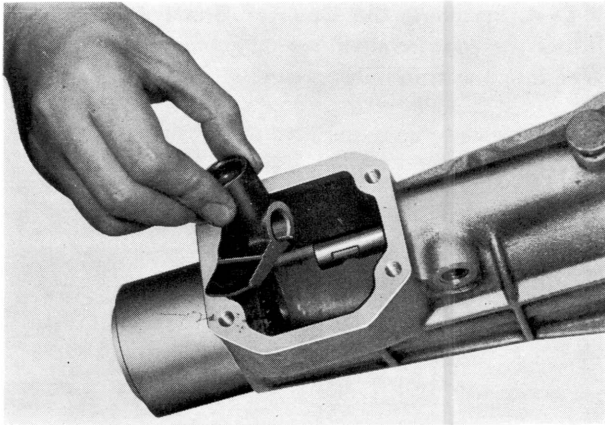

Fig. 7-16 Installing control lever end

3. Fit the friction piece and the spring to the extension and install the spring cap together with packing.

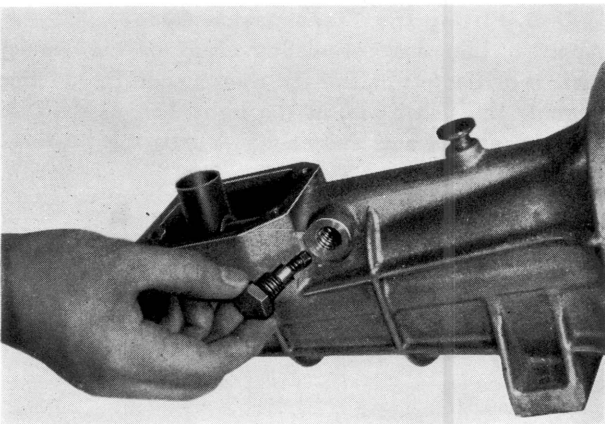

Fig. 7-17 Installing friction piece

4. Place the gasket on the rear side of the transmission case and install the extension assembly to the transmission case, with the control lever end held down to the left. Tighten the nuts. Check to ensure that the control lever operates properly.

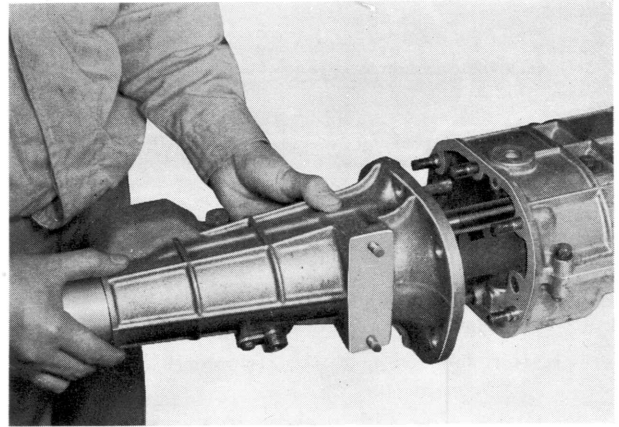

Fig. 7-18 Installing extension

7-D-8. Installing the Reverse Lamp Switch

Install the reverse lamp switch to the extension with the packing.

7-D-9. Installing the Speedometer Driven Gear Assembly

Install the speedometer driven gear assembly to the extension and secure with the lock plate.

7-D-10. Installing the Change Control Case

1. Insert the select lock spindle and the return spring from the inside of the control case. Install the locking ball and the spring in alignment with the spindle

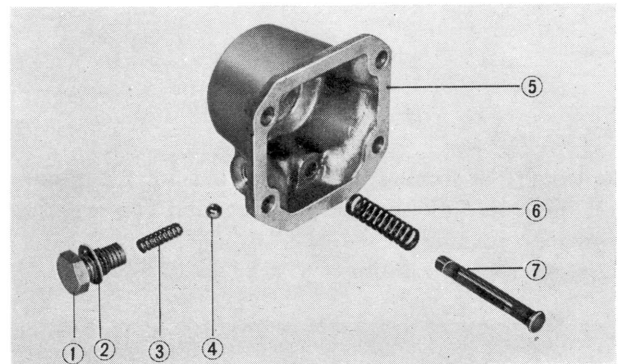

Fig. 7-19 Assembling control case

- | | |
|-----------------|------------------------|
| 1. Spring cap | 5. Control case |
| 2. Packing | 6. Spring |
| 3. Spring | 7. Select lock spindle |
| 4. Locking ball | |

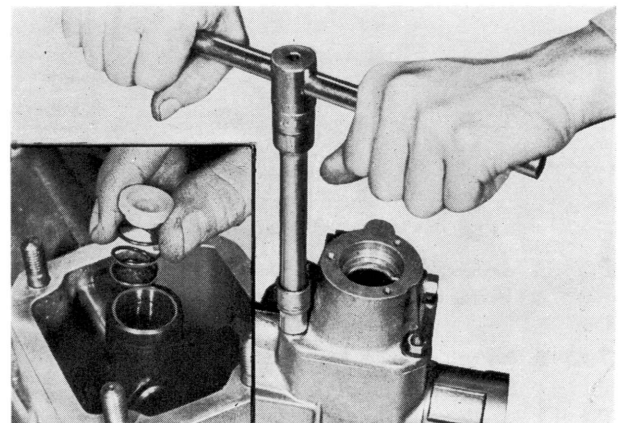

Fig. 7-20 Installing control case

groove and fit the spring cap together with packing. Install the set screw to the control case.

2. Insert the spring and the seat into the control lever end and install the control case assembly to the extension together with the gasket. (Refer Fig. 7-20)

7-D-11. Connecting the Reverse Lamp Wiring

Connect the reverse lamp wiring to the switch.

7-E. INSTALLING THE TRANSMISSION

1. Shift the transmission into top gear. Support the transmission with a jack and a block of wood and move it under the vehicle.

2. Lower the rear end of the transmission and align the centers of the main drive shaft and the clutch disk by raising the jack.

3. Move the transmission forward until the spline on the main drive shaft contact the spline on the clutch disk. Align the splines properly by turning the **main shaft holder** (49 0223 331) and after aligning the knock pin, mount the transmission to the engine body. Tighten the bolts. The earth wire is attached and secured to the bolt.

4. Raise the jack and install the transmission supporter to the side frame member. Tightn the nuts.

5. Remove the jack and connect the propeller shaft

to the transmission.

6. Install the exhaust pipe to the manifold.

7. Connect the speedometer cable to the speedometer driven gear assembly.

8. Install the release cylinder to the clutch housing and the return spring. If necessary, adjust the free play on the release fork. (See Par. 6-B)

9. Move the lever end from top gear to neutral. Align the groove on the spherical surface of the shift lever with the set screw on the control case and insert the tip of the shift lever into the control lever end. Then, fit the bush into the control case. Install the cover plate with the packing and tighten the bolts.

The operation of the shift lever may be adjusted by inserting adjust shims on the 3 bolts between the cover plate and the packing. The standard force of the shift lever at the knob is 2.0~4.0 kg (4.4~8.8 lb). Install the dust boots to the case.

After installing the starting motor, Connect the wirings of the starting motor and reverse lamp switch.

10. Supply the transmission with the proper amount of transmission oil though the dipstick gauge inlet. The following transmission oil are available :

SAE EP 80 Below -18°C (0°F)

SAE EP 90 Above -18°C (0°F)

11. Connect the earth wire to the battery.

SPECIAL TOOLS

49 0223 331	Main shaft holder
49 0187 441A	Shift fork rod guide
49 0187 451	Interlock pin guide

PROPELLER SHAFT

8-A. REMOVING THE PROPELLER SHAFT.....	8 : 1
8-B. CHECKING THE PROPELLER SHAFT.....	8 : 1
8-C. DISASSEMBLING THE UNIVERSAL JOINT	8 : 1
8-D. CHECKING THE UNIVERSAL JOINT	8 : 2
8-E. ASSEMBLING THE UNIVERSAL JOINT	8 : 2
8-F. INSTALLING THE PROPELLER SHAFT.....	8 : 2

PROPELLER SHAFT

The propeller shaft is of a unitized type with universal joints on both ends. A sliding joint is provided at the rear of the transmission extension and permits fore and aft movement of the propeller shaft during vertical movement of the rear axle.

8-A. REMOVING THE PROPELLER SHAFT

Remove the bolts that attach the propeller shaft to the companion flange of the differential carrier and pull out the sliding joint of the front of the propeller shaft from the extension.

8-B. CHECKING THE PROPELLER SHAFT

1. Check the deflection of the propeller shaft by supporting both ends of the propeller shaft on V blocks and applying a dial indicator. The permissible deflection is less than 0.4 mm. (0.016 in.).

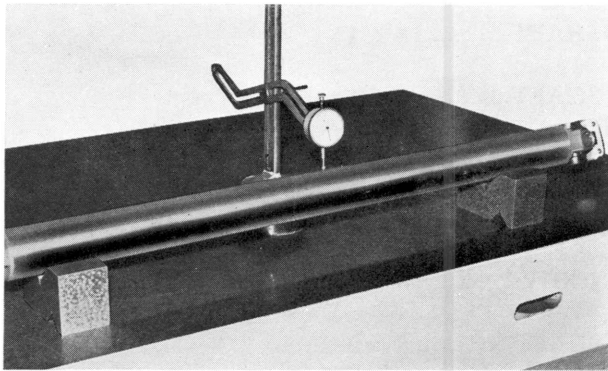

Fig. 8-1 Checking deflection

2. Check the propeller shaft for dynamic unbalance. If it is more than 15 cm-gr (0.20 in-oz) at 4,000 rpm, correct or replace the shaft. Excessive unbalance of the propeller shaft causes vibration and noise.

8-C. DISASSEMBLING THE UNIVERSAL JOINT

1. Punch mating marks on both the propeller shaft and the universal joint yoke.
 2. Remove the snap rings from the bearing cups.
 3. Install the **universal joint replacer** (49 0259 460) to the universal joint yoke as shown in Fig. 8-3.

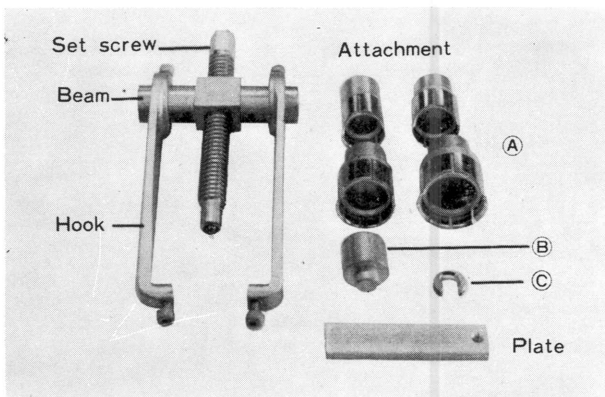

Fig. 8-2 Universal joint replacer

4. Screw in the set screw until the spider contacts with the yoke.

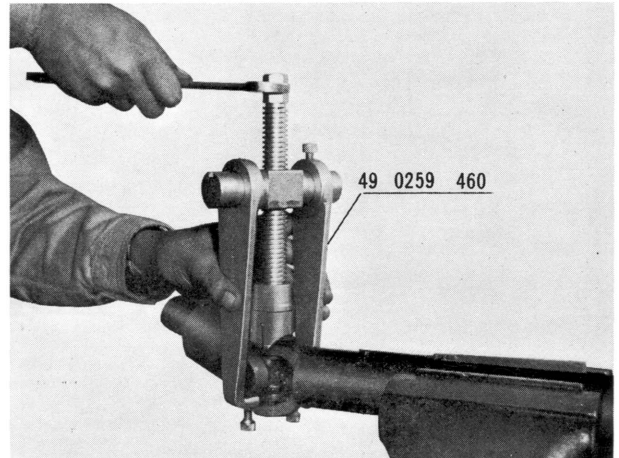

Fig. 8-3 Disassembling universal joint

5. Loosen the set screw and install the attachment (C) onto the spider as shown in Fig. 8-4.
 6. Screw in the set screw until the bearing cup protrudes from the yoke into the attachment (B).

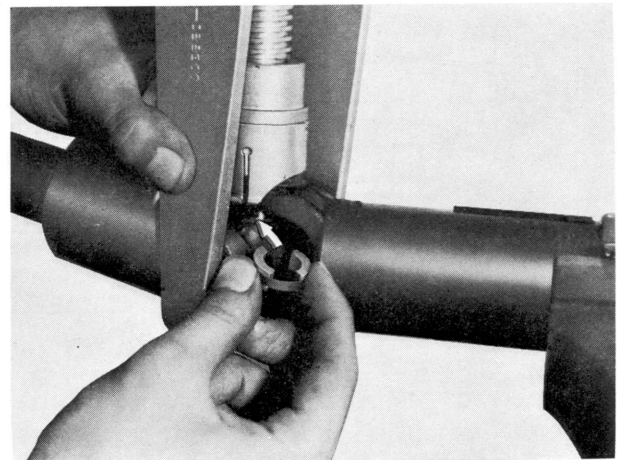

Fig. 8-4 Disassembling universal joint

7. Take out the bearing cup without dropping the needle roller bearings.
 8. Disassemble the other bearing cups in the same manner.

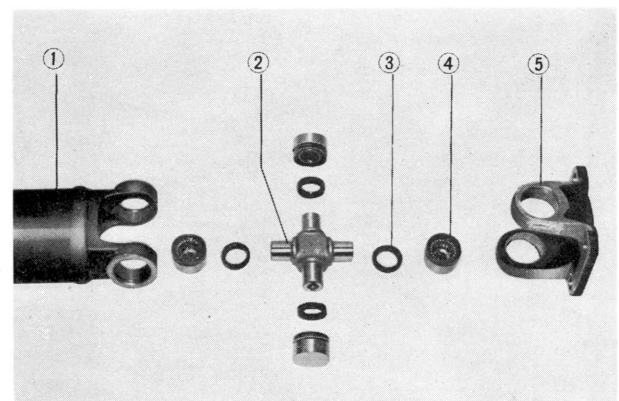

Fig. 8-5 Universal joint

- 1. Propeller shaft
- 2. Spider
- 3. Seal
- 4. Bearing
- 5. Yoke

8-D. CHECKING THE UNIVERSAL JOINT

1. Examine the bearing surfaces of the spider. They should be smooth and free from pits.
2. Measure the diameter of the spider. If the wear of the spider exceeds 0.1 mm. (0.04 in.), use a new one. The standard diameter is 14.72 mm. (0.5795 in.).

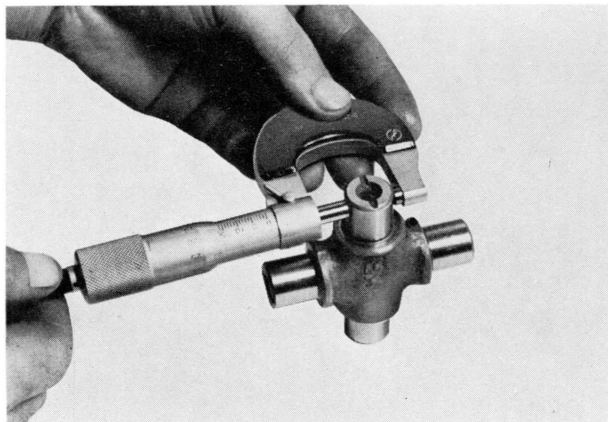

Fig. 8-6 Checking spider

3. Check the rollers in the bearing cups for wear or any damage. Rollers should have a uniformly good appearance and move freely inside the bearing cups.
4. Check the fit of the spider and bearing. If this clearance is more than 0.3 mm. (0.008 in.), replace the spider or bearing.

8-E. ASSEMBLING THE UNIVERSAL JOINT

1. Repack the bearing cup with grease, then place the needle rollers in the bearing cup.
2. Install the seal onto the bearing cup.
3. Place the spider in the yoke. Position the roller bearing assembly in the yoke.
4. Press-fit the roller bearing assembly into the yoke with the **universal joint replacer** while guiding the spider into the bearings until the snap ring can be installed in the grooves of the bearing cup.
5. Install the remaining two bearing assemblies on the spider as instructed above.

Note: When installing the joint yoke with the spider onto the propeller shaft, align the punched mating marks on both yokes.

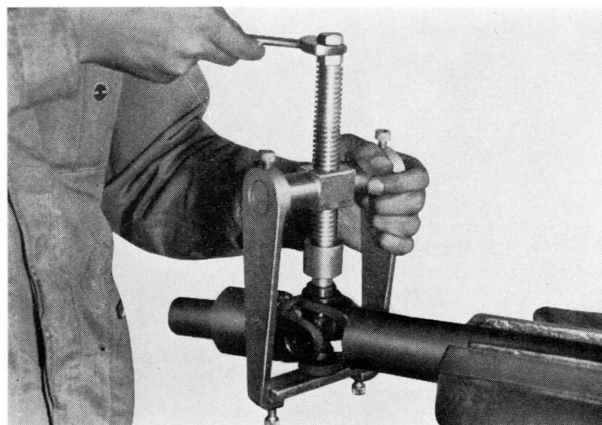

Fig. 8-7 Assembling universal joint

6. Install the snap rings to hold the bearing cups in the yokes. In this case, select properly sized snap rings so that the universal joint is placed in the center of the yokes.

The following snap rings are available :

1.20 mm. (0.047 in.)	1.45 mm. (0.057 in.)
1.25 mm. (0.049 in.)	1.50 mm. (0.059 in.)
1.30 mm. (0.051 in.)	1.55 mm. (0.061 in.)
1.35 mm. (0.053 in.)	1.60 mm. (0.063 in.)
1.40 mm. (0.055 in.)	

7. If necessary, check the dynamic balance of the propeller shaft assembly. The permissible unbalance on both centers of the universal joint at 4,000 rpm. is within 15 cm-gr (0.2 in-oz).

8-F. INSTALLING THE PROPELLER SHAFT

Attach the propeller shaft to the rear axle companion flange and the sliding joint on the transmission with bolts. Tighten the attaching bolts to 3.0 m·kg (21.7 ft·lb).

SPECIAL TOOL

49 0259 460 Universal joint replacer

REAR AXLE

9-A.	REAR AXLE SHAFT	9 : 1
9-A-1.	Removing the Rear Axle Shaft.....	9 : 1
9-A-2.	Disassembling the Rear Axle Shaft.....	9 : 1
9-A-3.	Checking the Bearing and Oil Seal.....	9 : 1
9-A-4.	Assembling the Rear Axle Shaft.....	9 : 2
9-A-5.	Installing the Rear Axle Shaft.....	9 : 2
9-B.	REMOVING AND DISASSEMBLING THE DIFFERENTIAL.....	9 : 2
9-B-1.	Removing the Differential Carrier.....	9 : 2
9-B-2.	Removing the Differential Assembly.....	9 : 2
9-B-3.	Disassembling the Differential Assembly.....	9 : 2
9-B-4.	Removing the Drive Pinion	9 : 3
9-B-5.	Removing the Pinion Bearing Outer Race.....	9 : 3
9-C.	DIFFERENTIAL INSPECTION.....	9 : 3
9-C-1.	Checking the Drive Pinion	9 : 3
9-C-2.	Checking the Ring Gear	9 : 3
9-C-3.	Checking the Differential Gears.....	9 : 3
9-C-4.	Checking the Bearings	9 : 3
9-C-5.	Checking the Companion Flange.....	9 : 4
9-C-6.	Checking the Oil Seal	9 : 4
9-D.	DIFFERENTIAL ASSEMBLY	9 : 4
9-D-1.	Adjusting the Pinion Height.....	9 : 4
9-D-2.	Adjusting the Pinion Bearing Preload.....	9 : 5
9-D-3.	Assembling the Differential	9 : 6
9-D-4.	Adjusting the Backlash	9 : 6
9-E.	INSTALLING THE REAR AXLE	9 : 7

REAR AXLE

MAZDA R100 Coupé is equipped with a semi-floating type rear axle with a hypoid ring gear and pinion set. The final reduction ratio is 4.111.

9-A. REAR AXLE SHAFT

9-A-1. Removing the Rear Axle Shaft

1. Remove the wheel and the brake drum.
2. Remove the brake shoe return springs.
3. Remove the brake shoes.
4. Remove the backing plate securing nuts and extract the axle shaft by using a **Puller** (49 0259 631 and 49 0223 630A), as shown in Fig. 9-1.

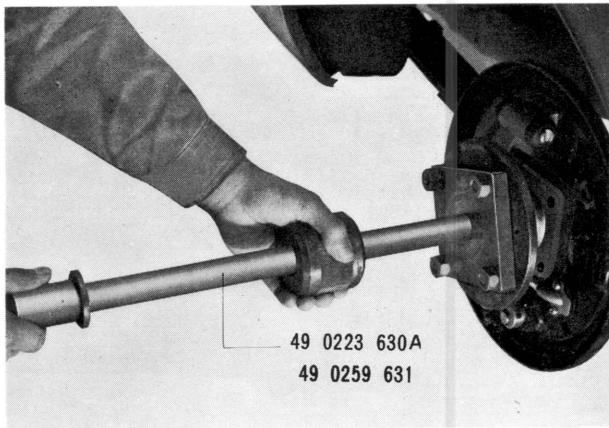

Fig. 9-1 Extracting rear axle shaft

5. Extract the rear axle shaft on the opposite side by the same method.

9-A-2. Disassembling the Rear Axle Shaft

1. Apply a thin coat of the engine oil to the rear axle shaft and press the shaft to extract slowly the spacer, bearing and bearing collar using the **bearing remover set** (49 0259 745).

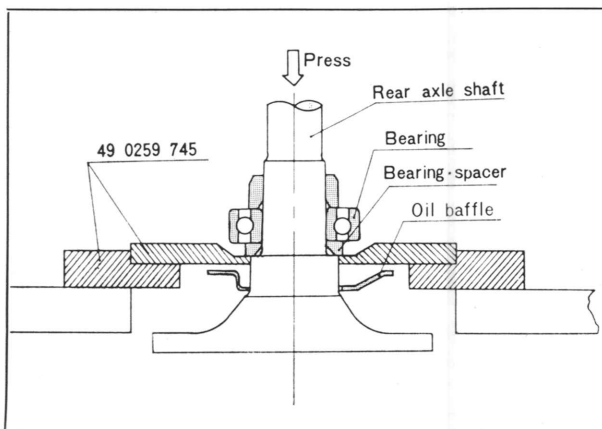

Fig. 9-2 Removing bearing collar and bearing

In case the pressure necessary to extract them exceeds 10 tons (22,000 lbs), remove the bearing collar following the method shown in Par. 9-A-2,2. When the bearing collar is re-usable but the pressing force of it is not within the range of 3~7 tons (6,600~15,400 lbs), it should be replaced with a new one.

2. If the bearing remover set is not available, remove it as follows:

- 1) Grind the bearing collar with a grinder and cut it with a chisel.



Fig. 9-3 Cutting bearing collar

- 2) Remove the bearing and the bearing spacer using a press.

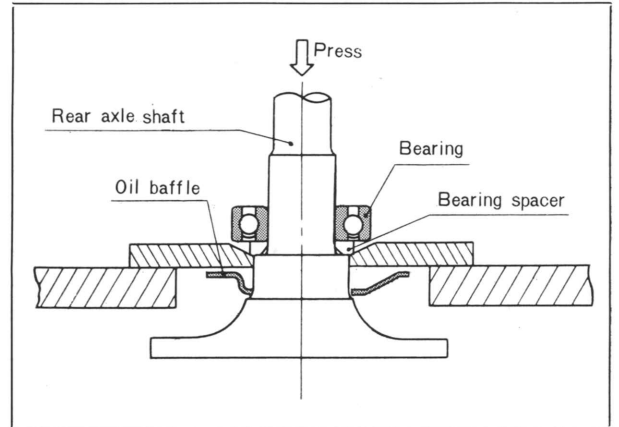

Fig. 9-4 Removing bearing

9-A-3. Checking the Bearing and Oil Seal

1. Check the bearing for roughness or noisy, and rotating the bearing outer race while applying pressure by hand. If excessive wear or damages are found, replace with new one.
2. Check the oil seal lip and replace it in case of

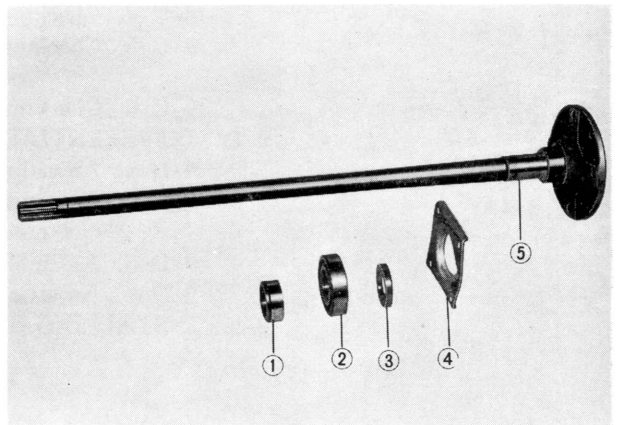

Fig. 9-5 Rear axle shaft assembly

- | | |
|-------------------|--------------------|
| 1. Bearing collar | 4. Oil baffle |
| 2. Bearing | 5. Rear axle shaft |
| 3. Bearing spacer | |

excessive wear or damage. And check the bearing collar contacts the oil seal. If excessive wear or score are found, replace with new one.

9-A-4. Assembling the Rear Axle Shaft

1. Insert the oil baffle and the bearing spacer.
2. Install the bearing onto the rear axle shaft with a press. The bearing should be fitted with the sealed side facing toward the wheel.
3. Install the bearing collar onto the rear axle shaft by using a press.

Note: Before press-fitting the bearing and the bearing collar, apply a thin coating of engine oil to the axle shaft to prevent damage, never use kerosene. If the bearing collar can be press-fitted with less than 3 tons (6,600 lbs) pressure, replace the bearing collar with a new one.

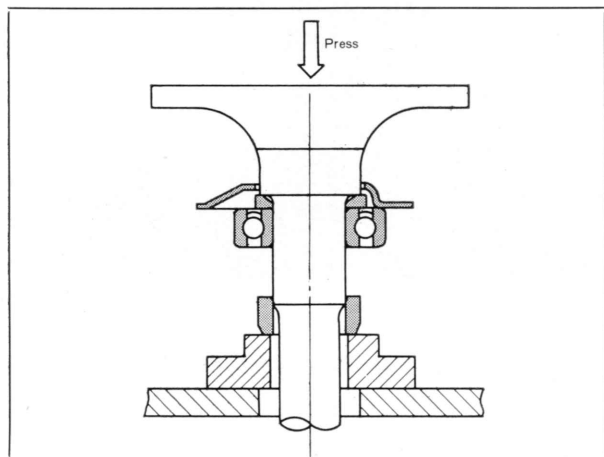

Fig. 9-6 Installing bearing and bearing collar

9-A-5. Installing the Rear Axle Shaft

1. Apply grease to the oil lip and install the oil seal into the rear axle casing by using a suitable installer.
 2. Install the rear axle shaft with the backing plate to the rear axle casing and fit the axle shaft spline to spline groove on the differential side gear.
 3. Check the fitting clearance between the rear axle casing and backing plate.
- Install an adjusting shim between the axle casing and

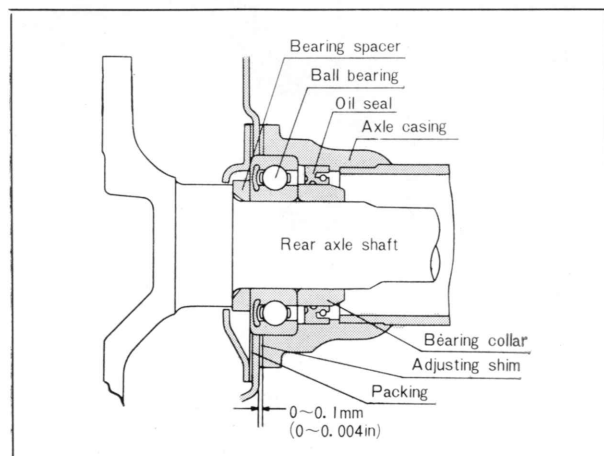

Fig. 9-7 Clearance of backing plate and housing

the backing plate so that the fitting clearance is 0~0.1 mm. (0~0.004 in.).

Adjusting shims are available in thicknesses of 0.1 mm. and 0.4 mm. (0.004 in. and 0.016 in.).

4. After adjusting the clearance, apply a thin coating of sealing agent to the adjusting shims and tighten the nuts securing the backing plate. The standard tightening torque is 2.5 m kg (18 ft-lb).
5. Install the brake shoe assemblies.
6. Install the brake drum and the wheel.

9-B. REMOVING AND DISASSEMBLING THE DIFFERENTIAL

9-B-1. Removing the Differential Carrier

1. Jack up the vehicle until the rear wheels are off the ground.
2. Drain the oil by removing the drain plug.
3. Remove the rear axle shafts, referring to Par. 9-A-1.
4. Disconnect the propeller shaft at the companion flange.
5. Remove the nuts supporting the carrier to the rear axle casing and remove the carrier.

9-B-2. Removing the Differential Assembly

Prior to disassembling the differential, check the ring gear for deflection, as detailed in Par. 9-C-2.

1. Mount the differential carrier on the **attachment** (49 0187 550) and **stand** (49 0164 550).
2. Punch matching marks on the bearing support of the carrier, the differential bearing cap and the adjuster for reassembly purposes.

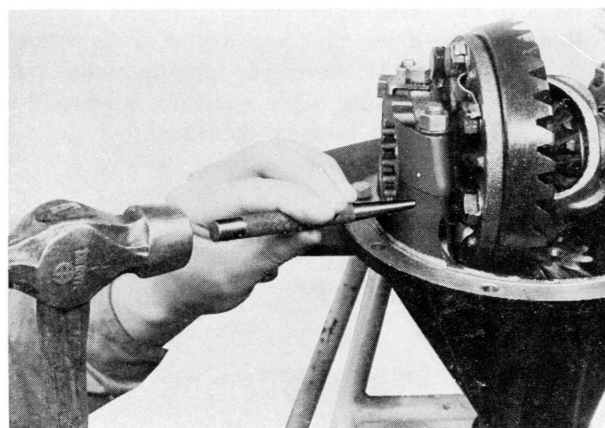

Fig. 9-8 Punching matching marks

3. Remove each bearing adjuster lock plate attaching bolt and remove the lock plates.
4. Loosen the bearing cap attaching nuts and back off the bearing adjusters slightly with a **adjust wrench** (49 0259 720) to remove the differential bearing preload.
5. Remove the nuts, bearing caps and bearing adjusters.
6. Remove the differential assembly with the bearing outer races. Make certain that each bearing outer race remains with its respective bearing.

9-B-3. Disassembling the Differential Assembly

1. Remove the differential bearings from the differential gear case with a suitable puller.
2. Straighten the tabs of lockwashers. Remove the

bolts and lockwashers that attach the ring gear case. Remove the ring gear.

3. Drive the pinion shaft lock pin out of the gear case from the back side of the ring gear flange with a suitable drift, as shown in Fig. 9-9.

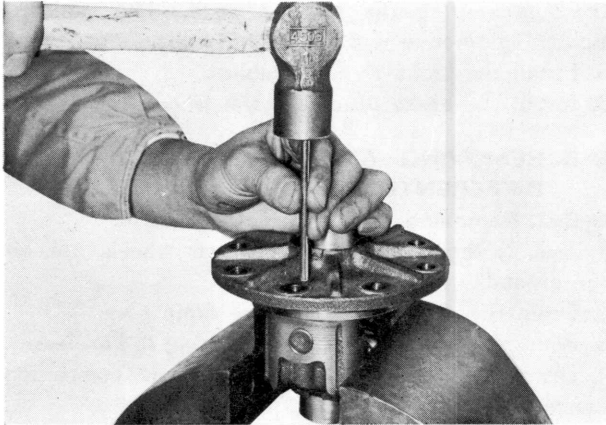

Fig. 9-9 Removing lock pin

4. Remove the pinion shaft.
5. Rotate the differential pinion gears 90 degrees and remove all pinion gears.
6. Remove the two differential side gears and the thrust washers.

9-B-4. Removing the Drive Pinion

1. Hold the companion flange with the **flange holder** (49 0259 710) and remove the drive pinion nut.
2. Remove the companion flange.
3. Remove the drive pinion and the rear bearing from the carrier. If necessary, tap the pinion out with a plastic hammer while carefully guiding the pinion with the hand to avoid damage.
4. Remove the oil seal and the front bearing.

9-B-5. Removing the Pinion Bearing Outer Race

The pinion bearing outer races can be removed from the carrier by using a brass drift in the slots provided for this purpose.

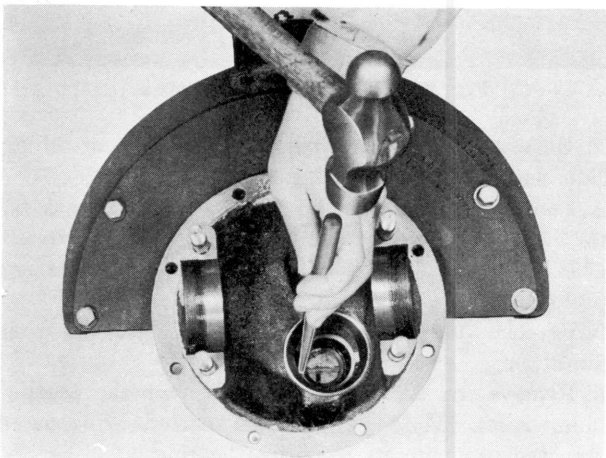

Fig. 9-10 Removing bearing outer race

9-C. INSPECTING THE DIFFERENTIAL

9-C-1. Checking the Drive Pinion

Check the drive pinion for damaged or excessively

worn teeth, damaged bearing journals and splines. If any of these conditions is found, replace both the drive pinion and ring gear as they are available only in matched sets.

9-C-2. Checking the Ring Gear

Inspect the ring gear for worn or chipped teeth. Check the deflection of the ring gear with a dial indicator while installed in the differential carrier. The permissible deflection is less than 0.1 mm. (0.004 in.). If replacement of the ring gear is necessary, both ring gear and drive pinion must be replaced.

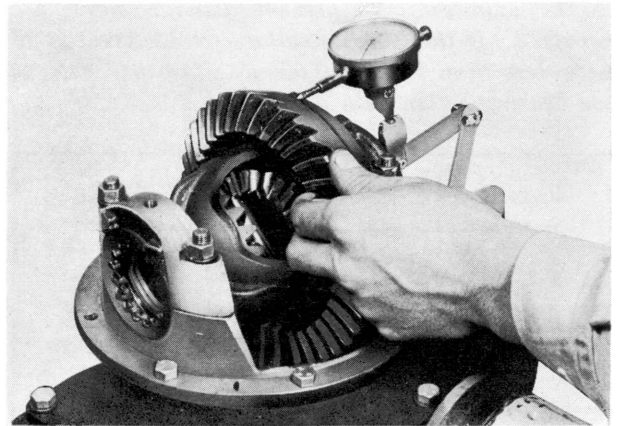

Fig. 9-11 Checking deflection

9-C-3. Checking the Differential Gears

Inspect the differential side gears and pinion gears for cracks, chipped teeth or any damage. Replace pinion gears, side gears or thrust washers if necessary. The pinion gear and pinion shaft are fitted with an allowance of 0.116~0.161 mm. (0.005~0.006 in.). If the clearance is considerable due to wear, replace with new parts. Check the spline-fit of the side gear and rear axle shaft. If it is 0.3 mm. (0.012 in.) or more, replace the side gear or rear axle shaft.

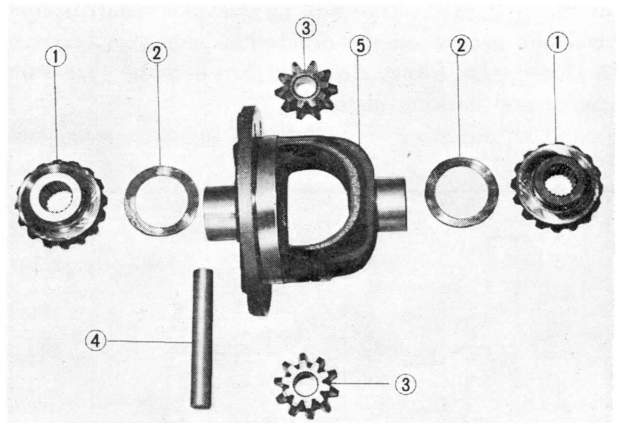

Fig. 9-12 Differential gear case assembly

- | | | |
|------------------|-----------------|--------------|
| 1. Side gear | 3. Pinion | 5. Gear case |
| 2. Thrust washer | 4. Pinion shaft | |

9-C-4. Checking the Bearings

Inspect the differential bearings and pinion bearings for wear, flaking or any damage. If inspection reveals that either bearing cone or outer race is unfit for

further service, replace the bearing.

9-C-5. Checking the Companion Flange

Check the companion flange for cracks, worn splines, or rough oil seal contacting surface. Repair or replace the companion flange if necessary.

9-C-6. Checking the Oil Seal

Check the oil seal for wear or damage. Excessive wear or damage causes oil leakages and eventually develops troubles due to oil shortage.

9-D. DIFFERENTIAL ASSEMBLY

9-D-1. Adjusting the Pinion Height

The drive pinion is correctly positioned in relation to the ring gear by the use of spacer which are placed between the drive pinion and pinion rear bearing.

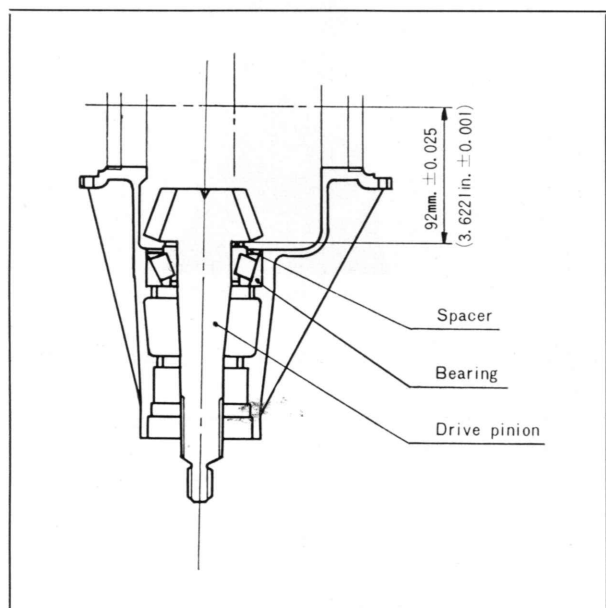

Fig. 9-13 Differential pinion height

The adjusting spacers are available in the following thickness, each marked with identification numbers:

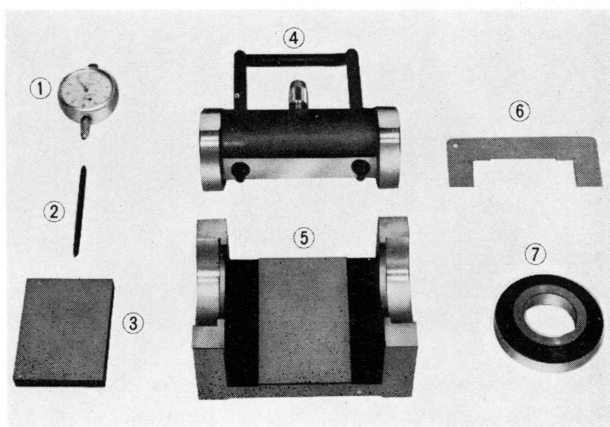

Fig. 9-14 Pinion height gauge

- 1. Dial indicator
- 2. Measuring rod
- 3. Gauge plate
- 4. Gauge body
- 5. Model
- 6. Gauge
- 7. Bearing model

No.	Thickness	No.	Thickness
08	3.08 mm. (0.1214 in.)	29	3.29 mm. (0.1298 in.)
11	3.11 mm. (0.1226 in.)	32	3.32 mm. (0.1310 in.)
14	3.14 mm. (0.1238 in.)	35	3.35 mm. (0.1322 in.)
17	3.17 mm. (0.1250 in.)	38	3.38 mm. (0.1334 in.)
20	3.20 mm. (0.1262 in.)	41	3.41 mm. (0.1346 in.)
23	3.23 mm. (0.1274 in.)	44	3.44 mm. (0.1358 in.)
26	3.26 mm. (0.1286 in.)	47	3.47 mm. (0.1370 in.)

The standard distance between the back of the drive pinion and the center of the ring gear (mounting distance) is 92 mm ± 0.025 (3.6221 in ± 0.0010). To adjust the pinion height, use the **pinion height gauge** (49 0221 570A) as instructed hereunder.

1. Insert the drive pinion with spacer into the bearing model and fit it in the carrier. Then install the spacer, front bearing, companion flange and tighten the nut to a torque of 18 m-kg (130 ft-lb).

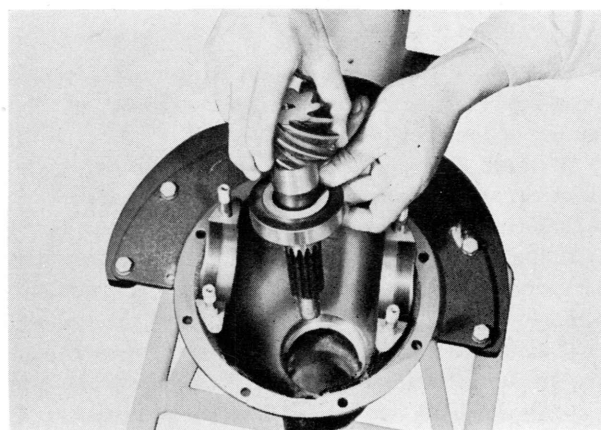

Fig. 9-15 Installing bearing pinion and model

2. Install the dial indicator and the measuring rod to the gauge body.

3. Set the gauge body on the surface plate and fix the dial indicator on the gauge body so that the pointer of the indicator to 1 or 2 mm. (0.04 or 0.08 in) Keep the gauge body at the position where the dial indicator reads the largest value by turning the gauge body slightly. At this position, set the reading to "0" by turning the outer ring of the dial indicator.

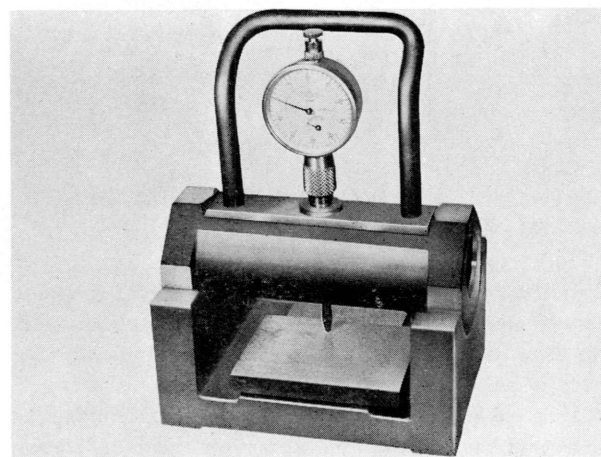

Fig. 9-16 Setting dial indicator

4. Place the gauge plate on the drive pinion, carefully place the gauge body as adjusted according to step 3, on the carrier and locate the pointer where the dial indicator reads the largest value by turning the gauge body slightly.

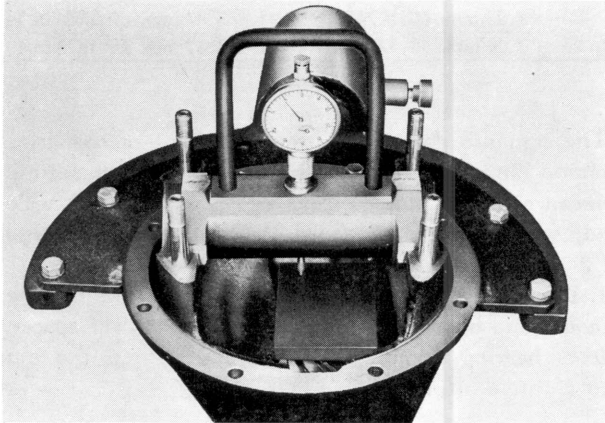

Fig. 9-17 Adjusting pinion height

5. Select an adjusting spacer with the proper thickness according to the direction and variation of the pointer of the dial indicator observed.

1) If there is no change in the readings of the indicator, the mounting distance is considered to be standard and there is no need for adjustment.

2) If the pointer moves clockwise, this indicates that the actual distance is shorter than the standard. Remove a spacer equal to the variation of the reading.

3) If the pointer moves counter-clockwise, this indicates that the actual distance is more than standard. Add a spacer equal to the variation of the reading.

6. Remove the drive pinion and the bearing model and place the bearing on a surface plate and set the gauge. Check the clearance between the gauge and the outer race surface of the bearing and between the gauge and the surface plate with a feeler gauge.

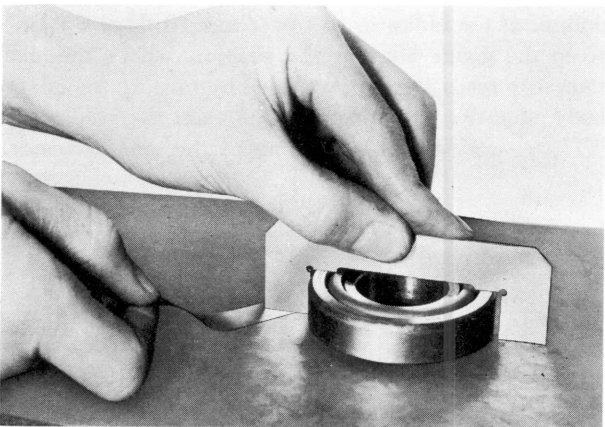

Fig. 9-18 Checking bearing model height

1) If the two surface in both cases are in complete contact and no clearance is found, this is indication that the bearing is of standard measurements and there is no need for adjustment.

2) If a clearance is found between the outer race surface of the bearing and the gauge, this is indication of the bearing being thinner than standard. Add a

suitable spacer equal in thickness to the clearance. 3) If a clearance is found between the gauge and the surface plate, this is indication of the bearing being thicker than standard. Remove a suitable spacer equal in thickness to the clearance.

7. Insert the spacer as determined in 5 and 6 into the rear side of the pinion gear, and press-fit the rear bearing to the drive pinion and insert both into the carrier.

9-D-2. Adjusting the Pinion Bearing Preload

1. Install the spacer and shims on the drive pinion.

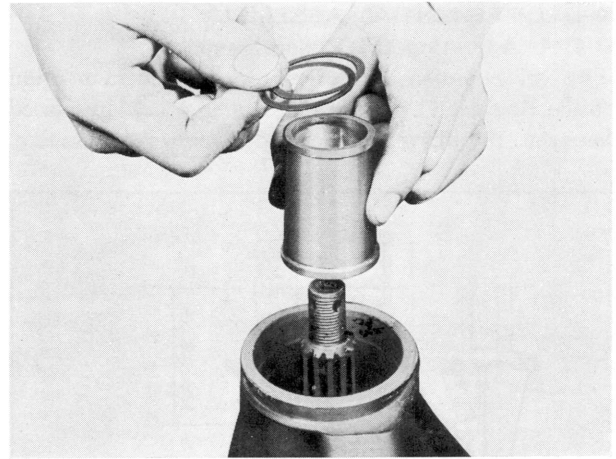

Fig. 9-19 Installing spacer and shims

2. Install the front bearing and companion flange (without the oil seal).

3. Tighten the companion flange attaching nut with a torque of 18 m·kg (130 ft·lb).

4. Test and adjust the bearing preload as follows: Use a torque wrench and read the torque during at least one full turn.



Fig. 9-20 Checking preload

The correct reading is 9~14 cm·kg (7.7~12 in·lb) and should be uniform during the full rotation.

If the preload is more than 14 cm·kg (12 in·lb), a thicker shim or longer spacer should be used under the front bearing. If the preload is less than 9 cm·kg (7.7 in·lb), a thinner shim or shorter spacer should be used.

The following shims are available.

Shims :

Identification mark	Thickness
4	0.34 mm. (0.0134 in.)
6	0.36 mm. (0.0142 in.)
8	0.38 mm. (0.015 in.)

Distance pieces :

Identification mark	Length
60	54.60 mm. (2.149 in.)
68	54.68 mm. (2.152 in.)
76	54.76 mm. (2.155 in.)
84	54.84 mm. (2.159 in.)

- After adjusting, install the oil seal and reassemble the companion flange.
- Tighten the companion flange attaching nut to 18 m-kG (130 ft-lb).

9-D-3. Assembling the Differential

- Install thrust washers on each of the differential side gears with oil pockets toward the gear, and position gears in the gear case.
- Insert both pinion gears through the opening of the gear housing. The two pinion gears must be located exactly 180° opposite each other.
- Then turn the pinion gears 90 degrees and align the holes on the pinion gears and the casing.
- Insert the pinion shaft through the case pinion gears. Check the backlash of the side gear and pinion gear.

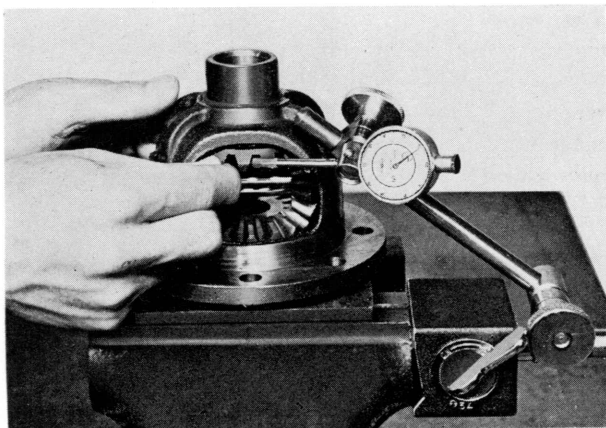

Fig. 9-21 Checking backlash

The backlash should be less than 0.1 mm. (0.004 in.). If it is more than 0.1 mm. (0.004 in.), adjust with side gear thrust washers.

The following thrust washers are available.

Identification mark	Thickness
6	1.6 mm. (0.063 in.)
7	1.7 mm. (0.066 in.)
8	1.8 mm. (0.070 in.)

- After adjusting, install the lock pin and secure it with a punch mark to prevent loosening during operation.
- Install the ring gear to the case.
- Insert the ring gear attaching bolts.

As there are two kinds of bolts, use those which fit the holes of the gear case flange. Tension each bolt to 5.0 m-kG (36 ft-lb).

- Bend the tabs of the lock plates to prevent loosening.
- Mount each differential bearing to the hubs of the gear case with an installing tool.
- Install the differential bearing outer races on its respective bearings, and place the differential gear assembly in the carrier, while making sure that the marks for backlash adjustment on the side faces of the pinion and ring gear teeth are aligned with each other.
- As there are two kinds of adjusters, right hand threaded and left hand threaded, note the identification marks on the adjusters and install each on the respective side.

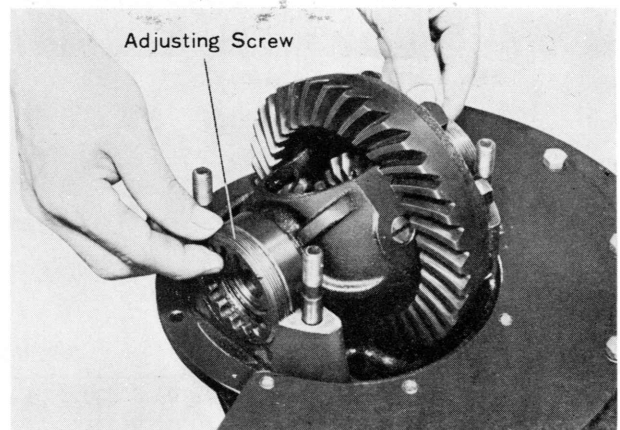

Fig. 9-22 Installing ring gear assembly

- Install the differential bearing caps and make sure that the identification marks on the caps correspond with those on the carrier. Install the attaching nuts.
- Turn the adjuster until the outer races are properly squared with the bearings and the end play is eliminated with some backlash remaining between the ring gear and drive pinion.
- Tighten one bearing cap nut on each side slightly and adjust the backlash, as described in Par. 9-D-4.

9-D-4. Adjusting the Backlash

- First verify that the marks for backlash adjust-

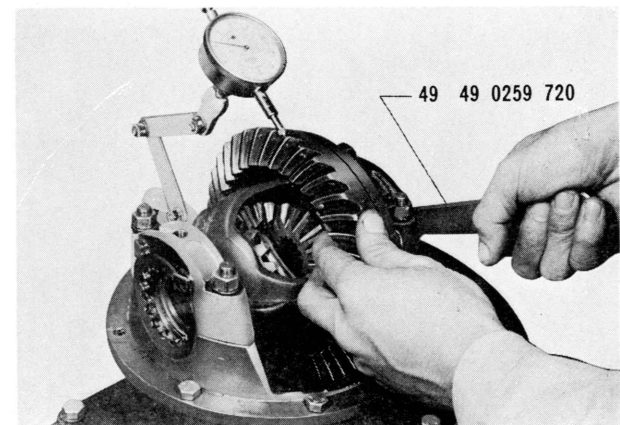

Fig. 9-23 Adjusting backlash

ments of the pinion and ring gears are matched each other.

2. Secure a dial indicator to the carrier flange so that the feeler squarely contacts one of the ring gear teeth.

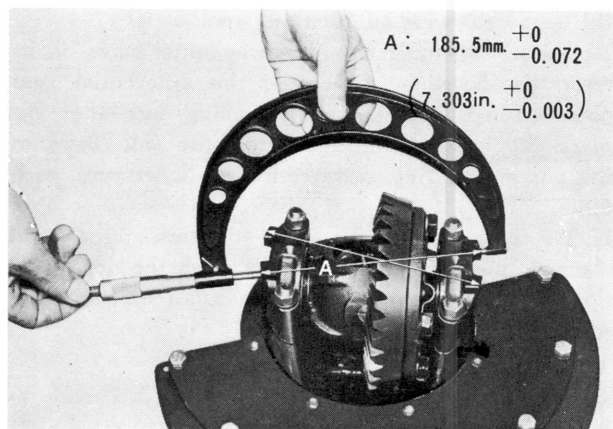

Fig. 9-24 Adjusting preload

3. By turning the adjusters evenly, adjust the backlash until it is 0.17~0.19 mm. (0.007~0.0075 in.), while tightening the adjusters to prestress the side bearings. Proper preload is obtained by tightening the adjusters until the diagonal at the bearing cap pilot portion reaches 185.5 mm. (7.303 in.). Check the backlash again after adjusting the preload.

4. Tighten the bearing cap nuts to 4.5 m-kg (32 ft-lb).

5. Install the adjuster lock plates on the bearing caps to prevent the adjuster from loosening.

9-E. INSTALLING THE REAR AXLE

1. Install the differential carrier assembly to the rear axle casing and attaching nuts.

2. Attach the propeller shaft to the companion flange of the carrier.

3. Install the rear axle shafts and adjust the end play, as described in Par. 9-A-5.

4. Refill the oil up to the level hole. (0.8 liters, 0.17 US. pints, 0.14 Imp pints)

SPECIAL TOOLS

49 0223 630A	Rear axle shaft puller
49 0259 631	Attachment (49 0223 630A)
49 0259 745	Bearing remover set
49 0187 550	Attachment
49 0164 550	Stand
49 0259 720	Adjust wrench
49 0259 710	Flange holder
49 0221 570A	Pinion height gauge

BRAKE

10-A.	BRAKE PEDAL ADJUSTMENT	10 : 3
10-B.	BRAKE MASTER CYLINDER	10 : 3
	10-B-1. Removing the Master Cylinder.....	10 : 4
	10-B-2. Disassembling the Master Cylinder.....	10 : 4
	10-B-3. Checking the Master Cylinder.....	10 : 4
	10-B-4. Assembling the Master Cylinder.....	10 : 4
	10-B-5. Installing the Master Cylinder.....	10 : 5
10-C.	FRONT BRAKE	10 : 5
	10-C-1. Replacing the Disk Brake Shoes	10 : 5
	10-C-2. Removing and Disassembling the Caliper...	10 : 6
	10-C-3. Inspecting the Caliper.....	10 : 6
	10-C-4. Assembling and Installing the Caliper.....	10 : 6
	10-C-5. Removing the Brake Disk.....	10 : 7
	10-C-6. Inspecting the Brake Disk.....	10 : 7
	10-C-7. Installing the Brake Disk	10 : 8
10-D.	REAR BRAKE	10 : 8
	10-D-1. Removing the Rear Brake Shoes	10 : 8
	10-D-2. Inspecting the Brake	10 : 8
	10-D-3. Installing the Rear Brake Shoes	10 : 8
	10-D-4. Adjusting the Rear Brake.....	10 : 9
	10-D-5. Removing and Disassembling the Wheel Cylinder...10 : 9	
	10-D-6. Checking the Wheel Cylinder	10 : 9
	10-D-7. Assembling and Installing the Wheel Cylinder...10 : 9	
10-E.	AIR BLEEDING	10 : 10
	10-E-1. Bleeding the Master Cylinder and Front Wheel Cylinder.....	10 : 10
	10-E-2. Bleeding the Rear Wheel Cylinder.....	10 : 10
10-F.	PARKING BRAKE	10 : 10

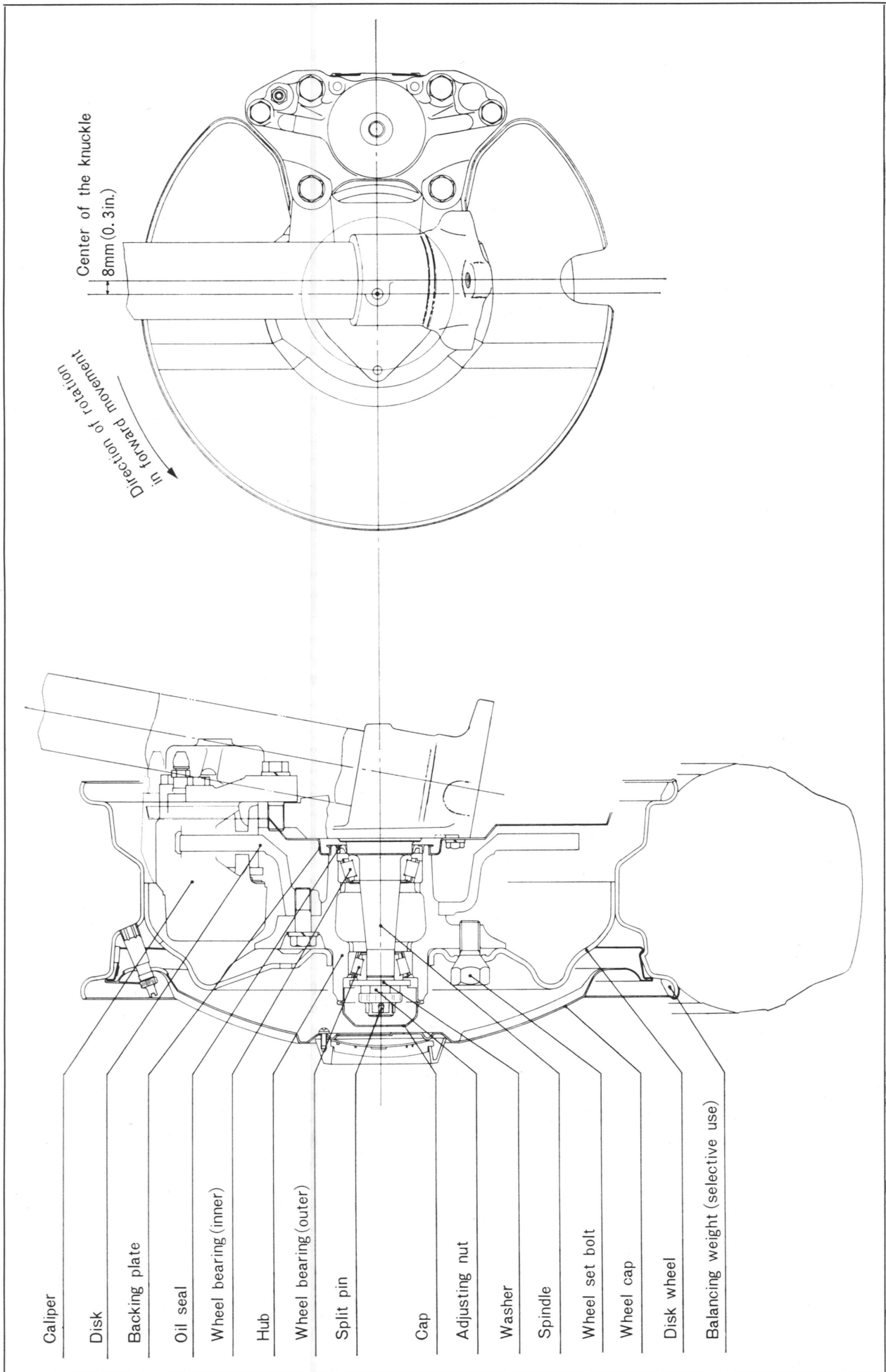

Fig. 10-1 Front brake

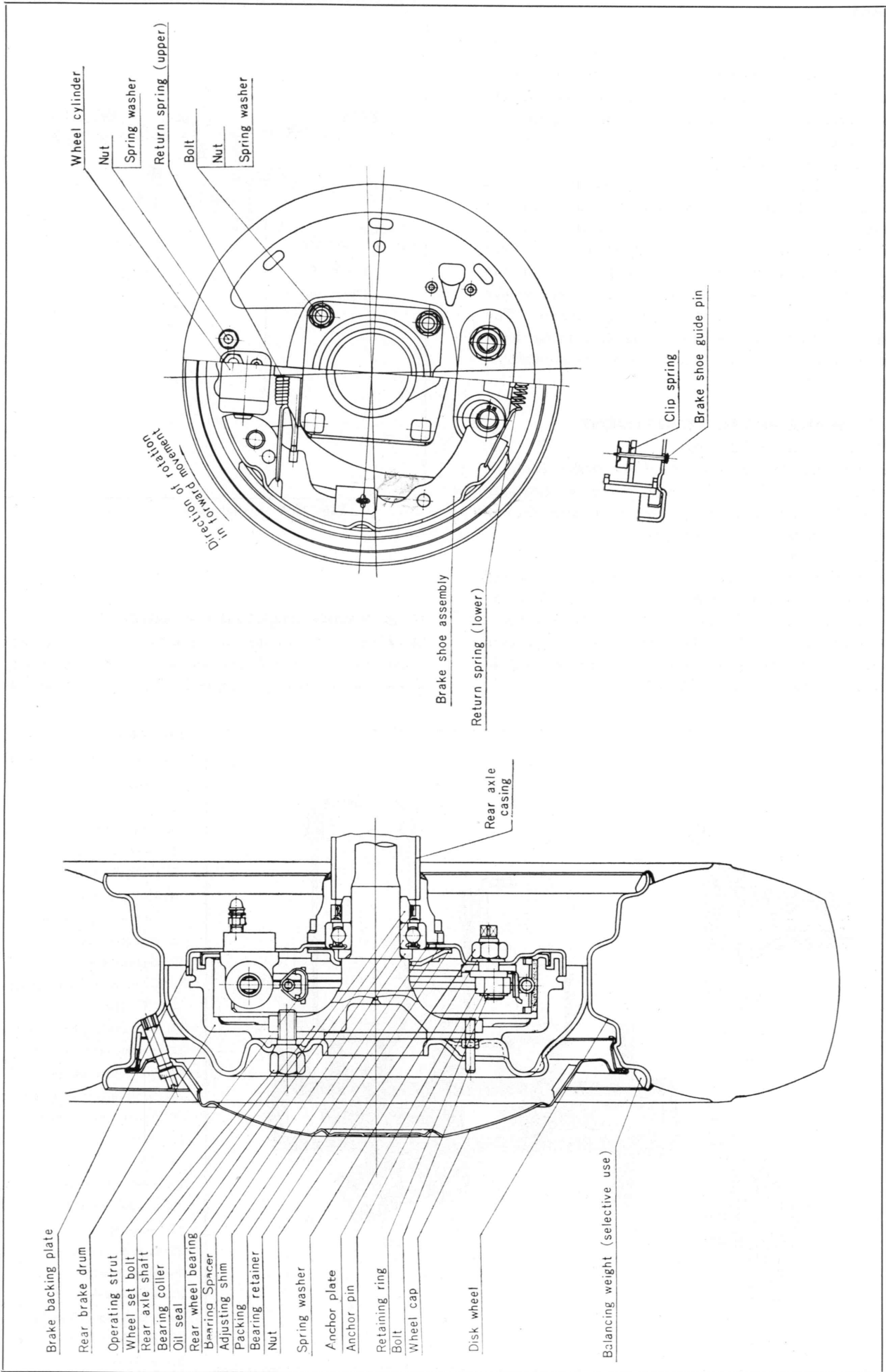

Fig. 10-2 Rear brake

BRAKE

The front brake units are of the disk brake type. The disks are attached to the hubs with which they rotate. A caliper is fitted at each steering knuckle. When braking, one of the pads is pressed against the inner side of the brake disk and other against the outer side, by each hydraulic piston.

When braking ceases, the pads are moved back just enough so that they are always at a certain minimum distance from the brake disk. This means that the front wheel brake units are self-adjusting. The rear brakes are of drum type. The upper end of the brake shoes rests against a double-acting wheel cylinder and the lower against the adjusting device. The parking brake is operated by means of a brake lever and influences both the rear wheels mechanically.

10-A. BRAKE PEDAL ADJUSTMENT

1. Adjusting the Pedal Height

The standard fitting position of the brake pedal is 175 mm. (68 in.) from the floor board as shown in Fig. 10-3. This adjustment is made by loosening the lock nut and turning the stopper bolt.

2. Adjusting the Free Play

The free play of the brake pedal before the oil compensating port on the master cylinder is closed by the piston cup should be 5~10 mm. (0.2~0.4 in.). To adjust the free play, loosen the lock nut and turn the master cylinder push rod. After proper adjustment is obtained, tighten the lock nut.

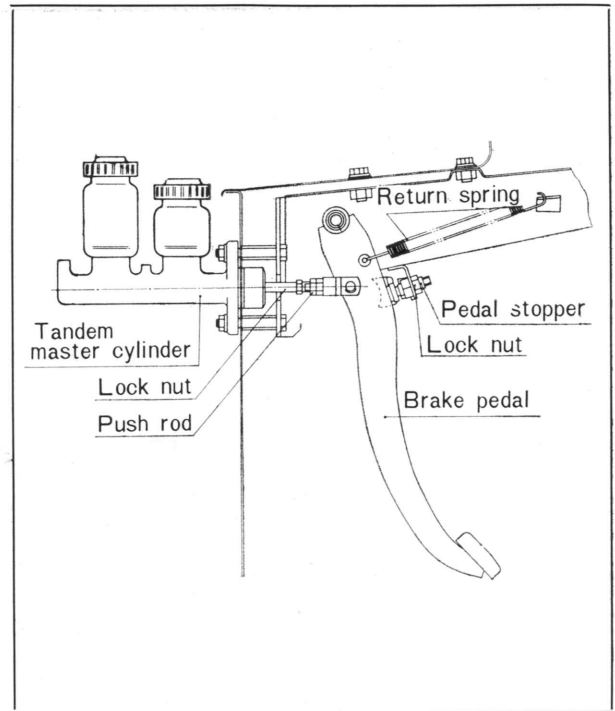

Fig. 10-3 Brake pedal

10-B. BRAKE MASTER CYLINDER

MAZDA R100 Coupé is equipped with a tandem master cylinder which assures you of still more safety when the brakes are applied. The tandem master

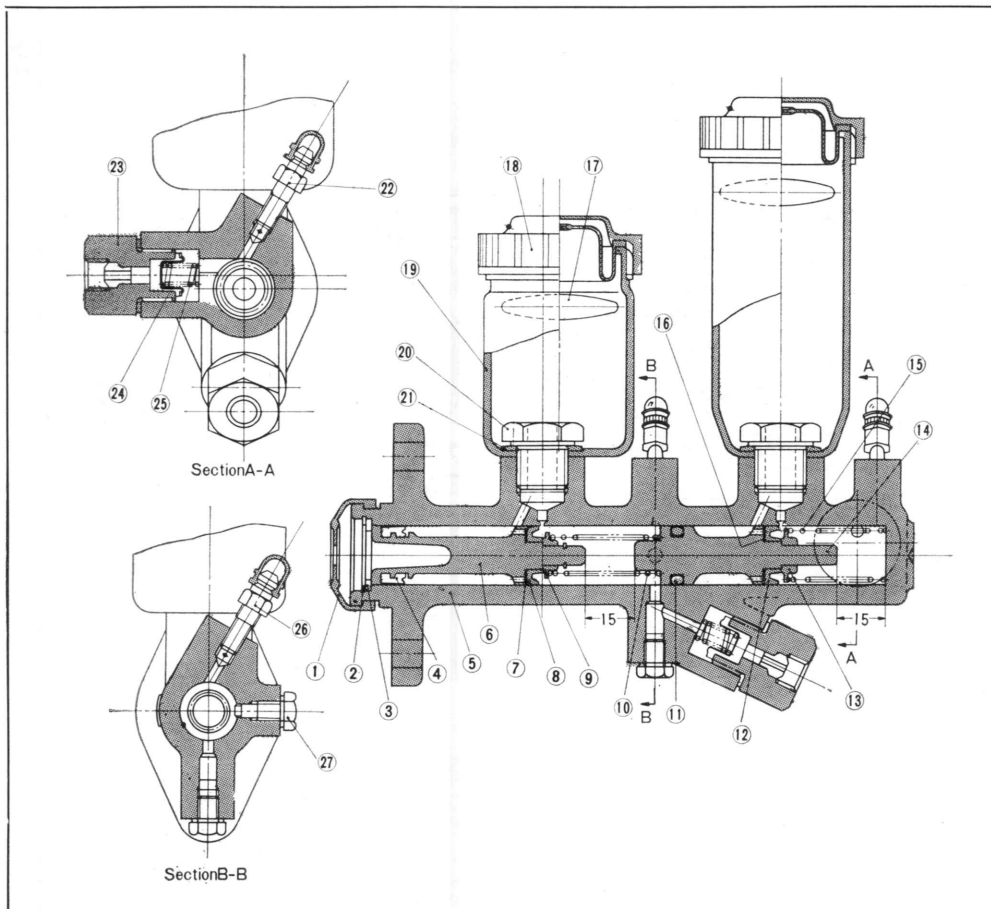

Fig. 10-4

Tandem master cylinder

1. Boot
2. Snap ring
3. Stop washer
4. Secondary cup
5. Cylinder body
6. Primary piston
7. Piston cup spacer
8. Primary piston cap
9. Spring seat
10. Primary return spring
11. "X" Ring
12. Secondary piston cup
13. Spring seat
14. Secondary piston
15. Secondary return spring
16. Piston cup spacer
17. Float
18. Cap
19. Reservoir tank
20. Connector bolt
21. Washer
22. Bleeder valve
23. Pipe fitting
24. Check valve
25. Check valve spring
26. Bleeder valve
27. Stop bolt

cylinder is so constructed that the front and rear brakes are independently actuated by oil pressure originated from the independent system, and that in the event of failure of one of the brakes, effective braking remains on two wheels, thus raising safety.

10-B-1. Removing the Master Cylinder

If it becomes necessary to remove the master cylinder for repair or overhaul, proceed as follows:

1. Disconnect the fluid pipes at the master cylinder outlets.
2. Remove the nuts that attach the master cylinder to the dash panel.
3. Pull the master cylinder straight out and away from the dash panel.

10-B-2. Disassembling the Master Cylinder.

1. Clean the outside of the master cylinder thoroughly and drain the brake fluid.
2. Remove the reservoir tanks from the cylinder.
3. Remove the dust boot from the cylinder.
4. With the snap ring pliers, remove the snap ring and remove the stop washer.
5. Remove the primary piston, piston cups, spring seat and return spring from the cylinder.
6. Loosen the secondary piston stop bolt.
7. Pushing in the secondary piston with a screwdriver, remove the stop bolt and insert the guide pin in its place.

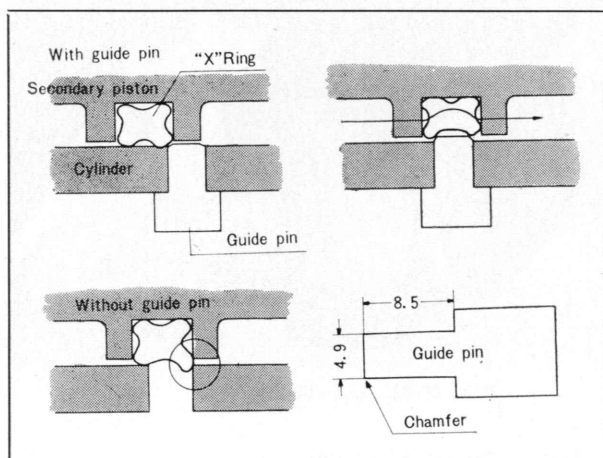

Fig. 10-5

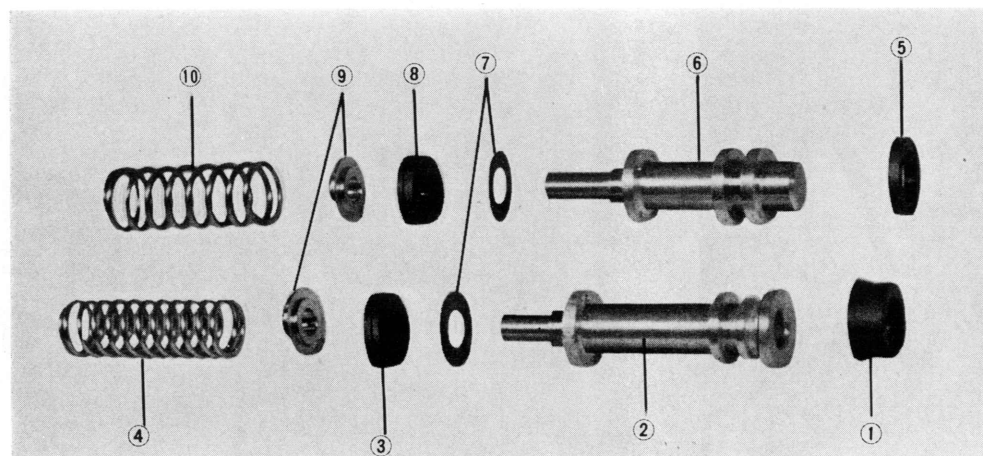

Fig. 10-7 Piston assembly

1. Secondary cup
2. Primary piston
3. Piston cup
4. Primary return spring
5. "X" Ring
6. Secondary piston
7. Piston spacer
8. Piston cup
9. Spring seat
10. Secondary return spring

Then, gradually take out the screwdriver and remove the secondary piston, piston cup, "X" ring, spring seat and return spring. If necessary, blow out with compressed air from the outlet hole.

8. Remove the fluid pipe fittings from the cylinder, and then remove the check valve and spring.

10-B-3. Checking the Master Cylinder

1. Wash the parts in clean alcohol or brake fluid. Never use gasoline or kerosene.
2. Check the cylinder bore and piston for wear, roughness or scoring.
3. Check the clearance between the cylinder bore and the piston. If it exceeds 0.1 mm. (0.004 in.), replace the piston or the cylinder.

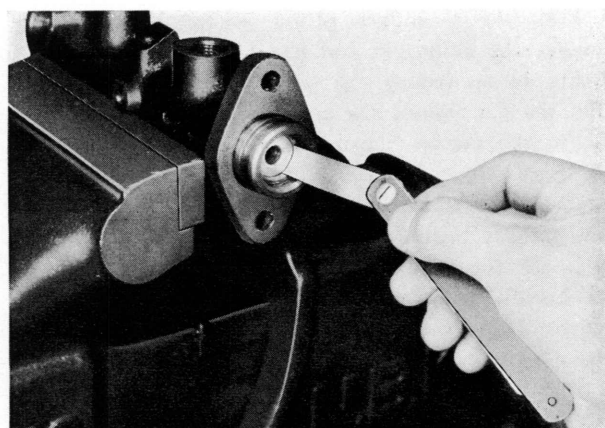

Fig. 10-6 Checking piston clearance

4. Make certain that the compensating port in the cylinder is clear.
5. Check the rubber cups and replace if they are damaged, worn, softened or swelled.

10-B-4. Assembling the Master Cylinder

1. Fit the check valve on the spring and place them in the outlet hole. Install the pipe fitting to the outlet hole. (Refer Fig. 10-8)
2. Insert the return spring of large coil diameter into the cylinder.
3. Fit the piston cup and "X" ring onto the secondary piston so that the flat side of the cup goes toward the piston.
4. Fit the guide pin into the stop bolt hole and insert

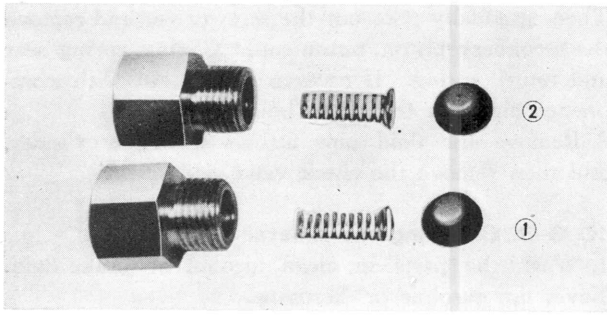

Fig. 10-8 Check valve

1. Primary check valve (rear brake)
2. Secondary check valve (front brake)

the secondary piston assembly with the spring seat into the cylinder.

5. Push the secondary piston as far as it will go, remove the guide pin and install the stop bolt.
6. Fit the secondary cup onto the primary piston so that the flat side of the cup goes toward the piston.
7. Fit the piston cup onto the primary piston, with the edge side of the cup facing the secondary piston.
8. Insert the return spring of small coil diameter and the primary piston assembly with the spring seat.
9. Install the stop washer and snap ring.
10. Install the dust boot to the cylinder.

Note: Make sure that the piston cups do not cover the compensating holes.

10-B-5. Installing the Master Cylinder

To install the master cylinder, carry out the removing operation in the reverse order. After installing, bleed the brake system, referring to Par. 10-E.

10-C. FRONT BRAKE

10-C-1. Replacing the Disk Brake Shoes

The lining should be inspected whenever the wheels are removed for any reason (tire rotation, etc.). The shoe and lining should be replaced, if the thickness of the shoe and lining is 7.5 mm. (0.3 in.) or less due to wear. To replace the disk brake shoes, proceed as follows:

1. Raise the vehicle and remove the wheel.
2. Remove the locking clips and pull out the guide pins.
3. Remove the shoe return spring and pull out the brake shoes.

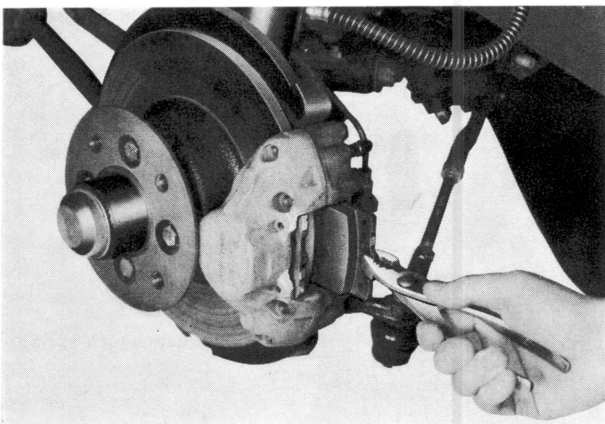

Fig. 10-9 Removing shoe

4. Attach a vinyl pipe to the bleeder valve and submerge other end of the pipe into a glass jar containing brake fluid.

5. Open the bleeder valve and press the pistons into the wheel cylinders with a **expanding tool** (49 0221 600B).

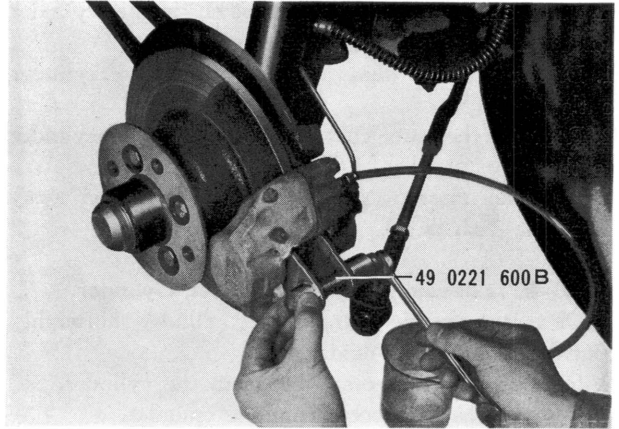

Fig. 10-10 Forcing back pistons

6. Tighten the bleeder valve and remove the vinyl pipe and the tool.

7. Insert the new brake shoes and shims in the caliper so that the arrow mark inscribed on the shim goes toward the direction of revolution of the disk.

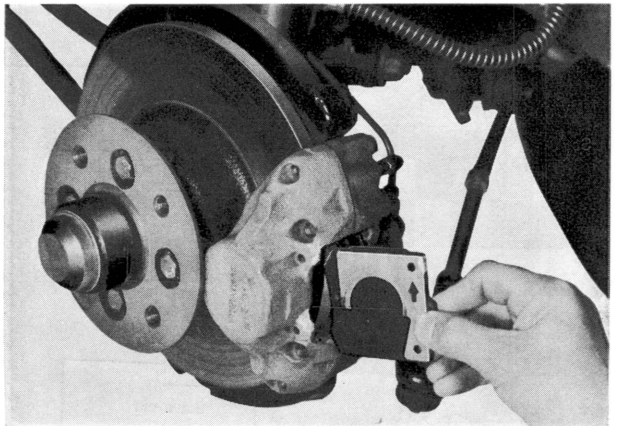

Fig. 10-11 Installing shim

8. Install the return spring.
9. Install the guide pins and the locking clips.

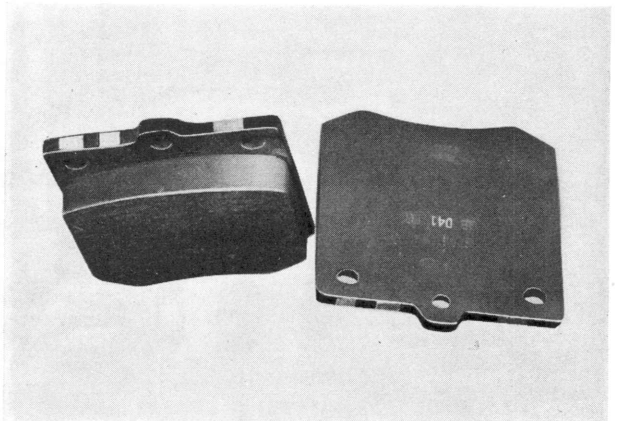

Fig. 10-12 Marks of shoe

10. Install the wheel and tighten the hub bolts to 9~10m·kg (65~72 ft·lb).

Note :

1. When the brake shoes are replaced, replace all the shoes on both wheels at the same time.
2. Do not mix different types of linings when replacing. Designated lining is marked D41 in letter code on the back of the shoe and the material of the lining is marked in color code of blue and yellow on the shoulder. (Refer Fig. 10-12)

10-C-2. Removing and Disassembling the Caliper

1. Jack up the vehicle and remove the wheel.
2. Disconnect the brake fluid pipe from the caliper. Plug the end of the fluid pipe to prevent entrance of dirt and loss of fluid.
3. Remove the attaching bolts and lift off the caliper.

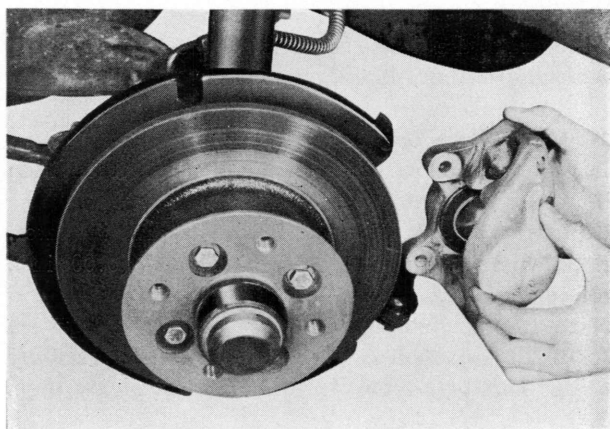

Fig. 10-13 Lifting off caliper

4. Clean the outside of the caliper and clamp the caliper in a vice.
5. Remove the brake shoes from the caliper. Mark the shoes so they can be reinstalled in their original positions.
6. Remove the four caliper bolts and separate the caliper halves.

Note : It usually is not advisable to separate the caliper halves unless oil leaks or any damages are found.

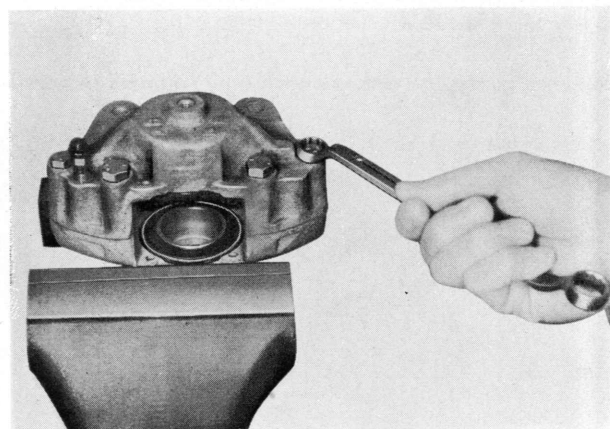

Fig. 10-14 Removing caliper bolt

7. Remove the dust seal retainer and the dust seal from the caliper and piston.

8. Gradually blow compressed air from the fluid pipe hole and remove the pistons out of each cylinder.
9. Remove the piston seal from the cylinder.

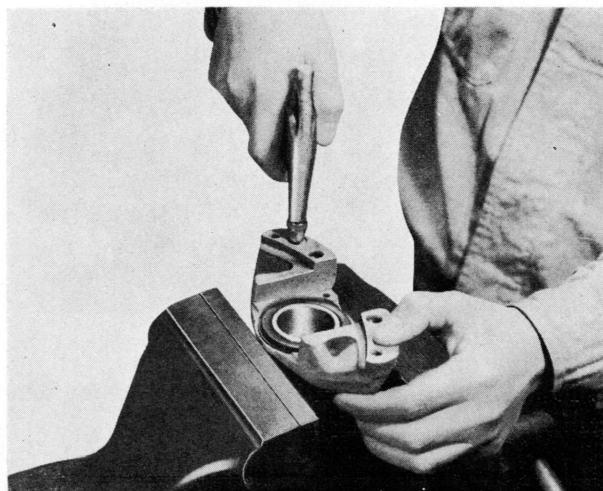

Fig. 10-15 Removing piston

10-C-3. Inspecting the Caliper

1. Before inspecting, wash all parts in clean alcohol or brake fluid. Never use gasoline or kerosene. Using a air hose, blow out the fluid passages in the caliper.
2. Inspect the cylinder bores and pistons for scoring, scratches or rust. If any of these conditions is found replace with new piston or caliper. Minor damage can be eliminated by means of polishing with crocus cloth.
3. The piston seals and dust boots should be replaced with new parts.

10-C-4. Assembling and Installing the Caliper

1. Apply brake fluid to the piston seal and install it into the cylinder groove.

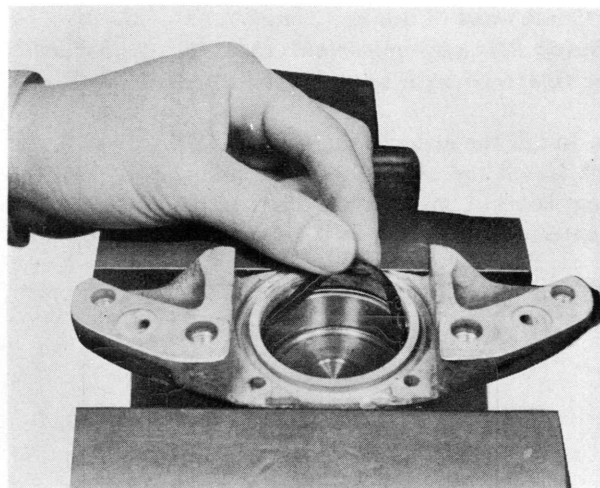

Fig. 10-16 Fitting piston seal

2. Install the dust boot in the piston groove.
3. Lubricate the cylinder bore and install the piston into the cylinder. (Refer Fig. 10-17)
4. Fit the outer bead of the dust boot to the caliper and secure it in position with the retainer.
5. Repeat steps 1 through 4 for other piston.

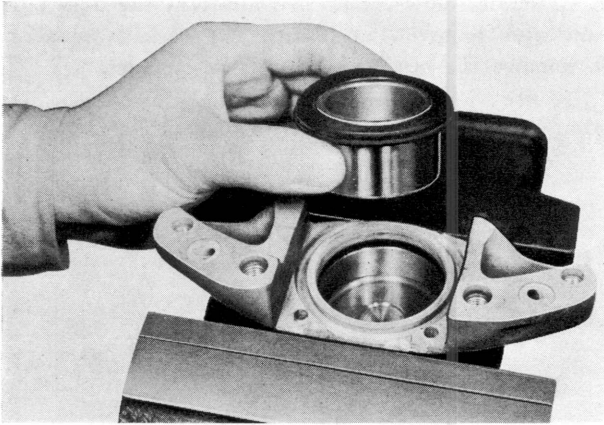

Fig. 10-17 Installing piston

6. Fit the "O" ring in small cavity around the fluid transfer hole of the caliper half.

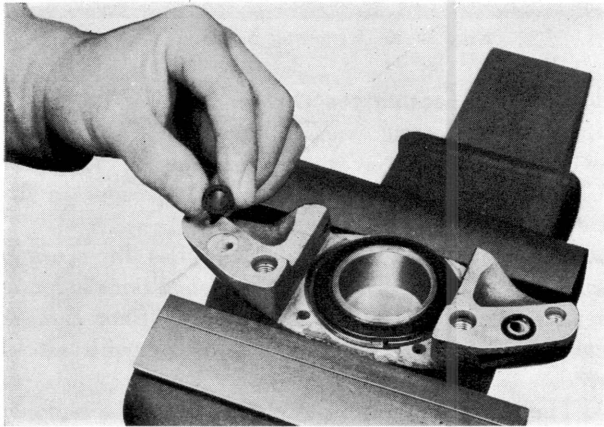

Fig. 10-18 Fitting "O" ring

7. Apply a thin coat of sealing agent to the mating surface of the caliper and fit the caliper halves together.

8. Install the caliper bolts and torque to 2.7 m-kg (19 ft-lb) and 5.5 m-kg (39 ft-lb.)

Note: It is very important that the caliper bolts be tightened with the specified torque.

9. Install the shoes in the caliper.

10. Install the caliper over the disk and to the steering knuckle so that the disk is positioned in the center of both linings. If necessary, insert the shim

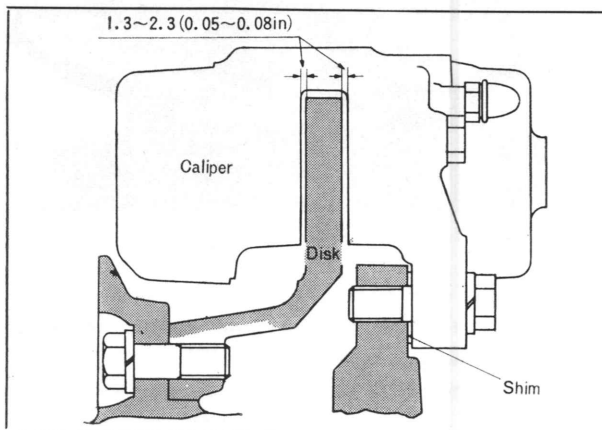

Fig. 10-19 Installing caliper

between the caliper and the steering knuckle. The shims are available in thicknesses of 0.2 mm. (0.008 in.), 0.6 mm. (0.024 in.) and 0.8 mm. (0.032 in.).

11. Tighten the caliper attaching bolts to 5.0 m-kg (35 ft-lb).

12. Connect the brake fluid pipe and bleed brake line, as described in Par. 10-E.

13. Install the wheel.

10-C-5. Removing the Brake Disk

To remove the brake disk, proceed as follows:

1. Jack up the vehicle and remove the wheel.

2. Remove the caliper.

3. Remove the grease cap, split pin and bearing adjusting nut.

4. Pull the wheel hub and brake disk assembly off the spindle.

5. Clamp the wheel hub and brake disk assembly in the vice.

6. Separates the brake disk from the wheel hub by removing the attaching bolts.

10-C-6. Inspecting the Brake Disk

Inspect the friction surface of the disk and recondition if it is scored, scratched or rusted.

Check the run-out of the disk with a dial indicator. If the run-out is more than 0.07 mm. (0.003 in.), reface the disk.

Note: Make certain that the wheel bearings are correctly adjusted and the disk is fitted securely on the hub, before checking the run-out of the disk.

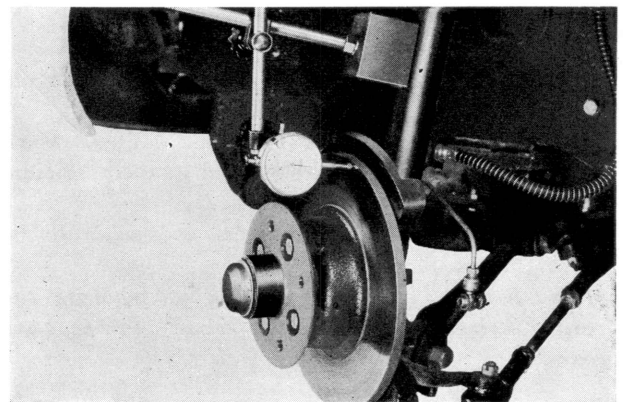

Fig. 10-20 Checking run-out

When refacing the disk, remove only so much material

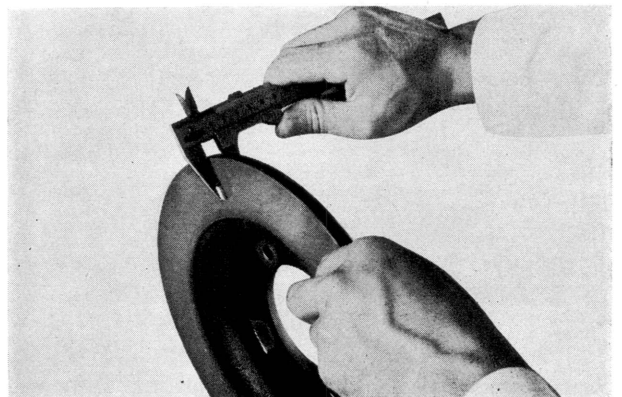

Fig. 10-21 Checking disk thickness

as is necessary to clean up the disk. The thickness of the disk after refacing must not be less than 7.0 mm. (2.755 in.).

10-C-7. Installing the Brake Disk

Carry out the removing operation in the reverse order. After installing, adjust the bearing preload.

The procedure for adjustment is as follows:

Tighten the wheel bearing adjusting nut with a wrench until the hub begins to turn with the torque of 0.02~0.05 m·kg (1.7~4.3 in·lb).

When measuring the preload with a spring scale at the hub bolt, it is 0.4~0.9kg (0.9~2.0 lb).

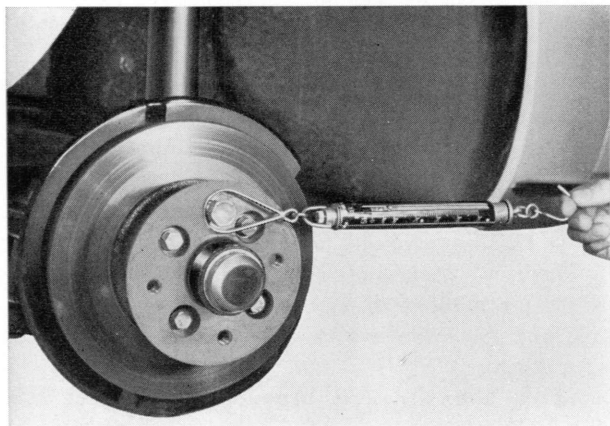

Fig. 10-22 Checking preload of wheel bearing

10-D. REAR BRAKE

10-D-1. Removing the Rear Brake Shoes

1. Raise the vehicle and remove the wheel.
2. Remove the drum attaching bolts and fit them into the tapped holes and screw them in evenly to force the drum away from the axle shaft flange.

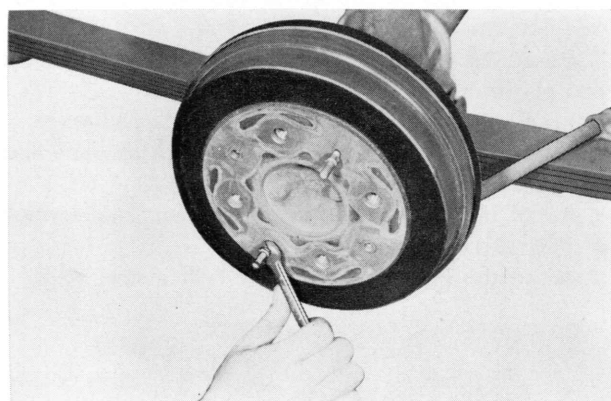

Fig. 10-23 Removing rear brake drum

3. Remove the brake shoe return springs.
 4. Remove the brake shoe guide pin and retaining spring by compressing the retaining spring and turning the guide pin 90 degrees.
 5. Disengage the parking brake cable from the operating lever on the brake shoe.
- Remove the brake shoes.

10-D-2. Inspecting the Brake

a. Inspecting the brake drum

Inspect the brake drum and recondition if it is rough

or scored. Check the out of round with a dial indicator. If it is 0.02 mm. (0.0008 in.) or more, reface the drum. When refacing the drum, remove only so much material as is necessary to obtain a smooth surface on the drum. Do not reface more than 1.0 mm. (0.0394 in.). The standard inner diameter of the drum is 200 mm. (7.84 in.).

b. Inspecting the brake lining

1. Inspect the brake linings and replace with new parts if the linings are badly burned or worn.
2. Examine the lining contact pattern. For inspection, chalk the entire inner surface of the brake drum and slide the lining along the chalked surface. The lining should show contact across the entire width, extending from toe to heel. Shoes showing contact only on one side should be replaced. Shoes having sufficient lining but lack of contact should be ground properly.
3. If oil or grease is evident on the lining, wash off oil or grease in a suitable solvent. Then, correct the cause of leakage. If the lining is saturated with oil or grease, replace it.

c. Inspecting the wheel cylinder

Examine whether exterior of the wheel cylinder boots is wet with brake fluid. Excessive amounts of fluid at these points indicate leakage past the piston cups. Therefore, the wheel cylinder must be overhauled.

d. Inspecting the brake line

Inspect all brake lines for leakage with the foot brake applied. Check all brake pipe, hoses and connections for signs of chafing, deterioration or other damage.

10-D-3. Installing the Rear Brake Shoes

1. Lubricate the mating surfaces of the shoes and backing plate ledges with a small amount of grease.
2. Install the eye of the parking brake cable onto the parking brake operating lever installed to the front side shoe with a clip.
3. Installing the operating strut between the slots of the shoes, engage the brake shoes with the slots in the wheel cylinder pistons.

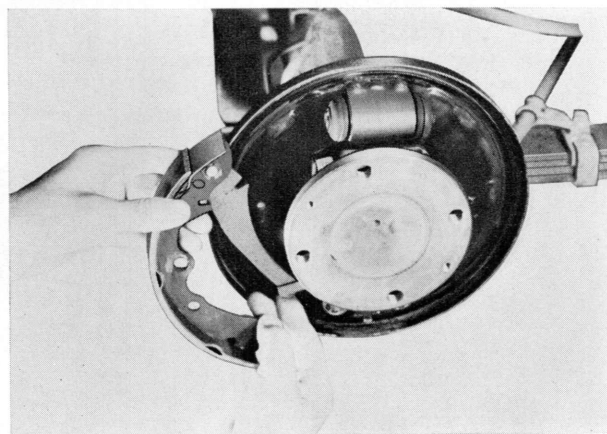

Fig. 10-24 Installing operating strut

4. Hold the brake shoes to the backing plate with the retaining springs and guide pins.
5. Install the shoe return springs.

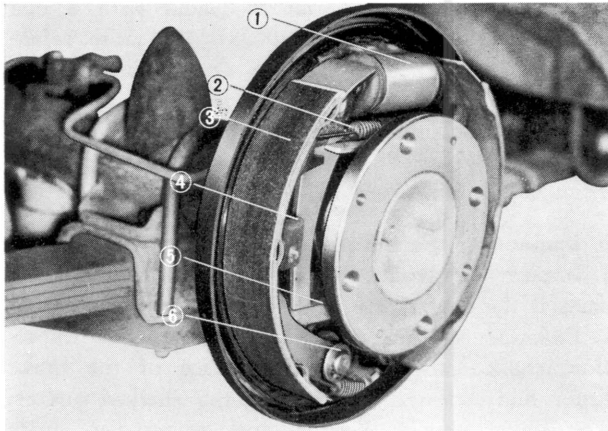

Fig. 10-25 Rear brake

- | | |
|----------------------------------|-----------------------|
| 1. Wheel cylinder | 4. Clip |
| 2. Operating strut return spring | 5. Parking brake wire |
| 3. Brake shoe | 6. Anchor pin |

6. Sand the linings lightly to remove any trace of dirt or grease.
7. Install the brake drum to the axle shaft flange.
8. Apply the brake pedal several times and adjust the brake, as instructed in Par. 10-D-4.
9. Install the wheel.

10-D-4. Adjusting the Rear Brake

1. Jack up the vehicle until the wheels are free to turn.
2. Loosen the lock nut with a wrench and holding the lock nut, turn the anchor pin toward the arrow

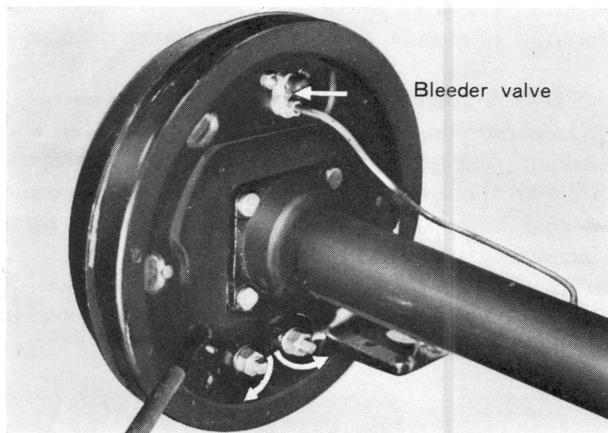

Fig. 10-26 Adjusting brake shoe

direction shown in Fig. 10-26, until the brake drum can not be rotated. Then, back off the anchor pin until the drum just turns freely.

3. Hold the anchor pin in this position and tighten the lock nut.
4. Repeat the above adjustment on each wheel. The adjustment should be equal at all wheels.

10-D-5. Removing and Disassembling the Wheel Cylinder

1. Remove the brake shoes, as described in Par. 10-D-1.
2. Disconnect the brake fluid pipe at the wheel cylinder. Plug the end of the brake fluid pipe.
3. Remove the nuts attaching the wheel cylinder to the backing plate. Remove the wheel cylinder.
4. Remove the dust boots and pistons from both ends of the cylinder.
5. Press in the piston cup and force out the piston cup, filling blocks and return spring.

10-D-6. Checking the Wheel Cylinder

1. Wash all parts in clean alcohol or brake fluid. Never use gasoline or kerosene.
2. Check the cylinder bore and pistons for roughness or scoring.
3. Check the clearance between the cylinder and piston. If it is more than 0.1 mm. (0.004 in.), replace with new parts.
4. Check the piston cups and replace if they are damaged, worn, softened or swelled.

10-D-7. Assembling and Installing the Wheel Cylinder

1. Dip the pistons, piston cups, filling blocks and return spring in brake fluid.
2. Install the piston cup in the cylinder with the flat side outward.
3. Install the filling block, return spring, filling block and piston cup in sequence.
4. Install the pistons and boots onto the cylinder.
5. Install the wheel cylinder to the backing plate and tighten the nuts. Connect the fluid pipe.
6. Install the brake shoes and the drum, as described in Par. 10-D-3.
7. Bleed the brake line, as described in Par. 10-E.

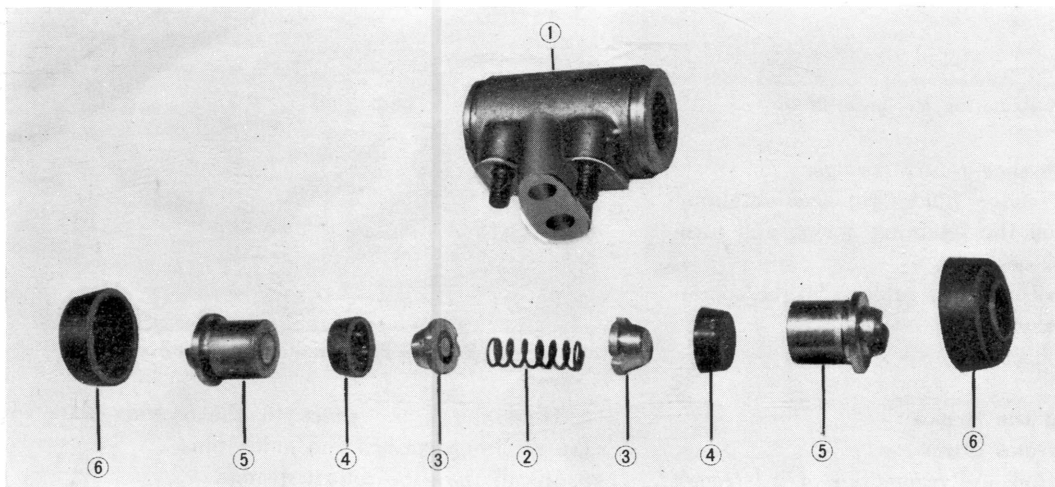

Fig. 10-27

Rear wheel cylinder

1. Wheel cylinder
2. Spring
3. Filling block
4. Piston cup
5. Piston
6. Dust cover

10-E. AIR BLEEDING

Whenever the wheel cylinder or master cylinder is overhauled or air enters the system, air bleeding must be carried out. The correct sequence of bleeding is to bleed master cylinder first and either front or rear wheel cylinder second.

10-E-1. Bleeding the Master Cylinder and Front Wheel Cylinder

To bleed the master cylinder and the front wheel cylinder, proceed as follows:

1. Fill the reservoirs.
2. Remove the bleeder valve cap and connect a vinyl pipe to the bleeder valve. Submerge the other end of the pipe in the brake fluid in a glass jar.
3. Open the bleeder valve. Depress the brake pedal a full stroke and allow it to return slowly. Continue this pumping action until air bubbles cease to appear in the jar.
4. When bleeding operation is completed, close the bleeder valve, remove the vinyl pipe and fit the cap to the bleeder valve.

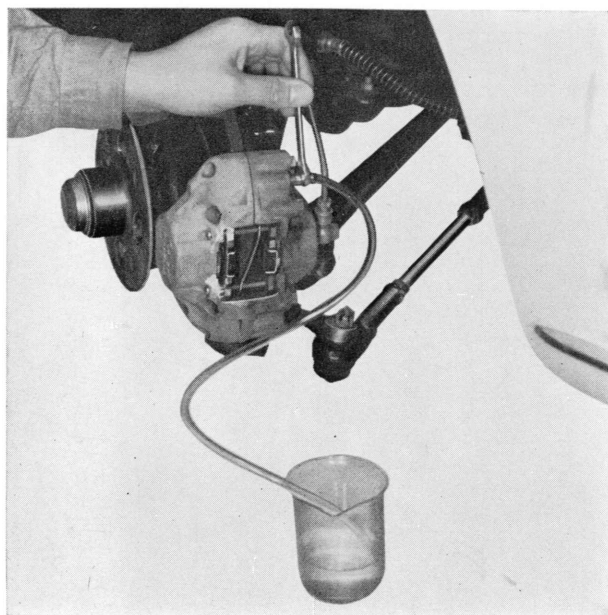

Fig. 10-28 Air bleeding

Note: During bleeding operation, the reservoirs of the master cylinder must be kept at least $3/4$ full of the brake fluid.

10-E-2. Bleeding the Rear Wheel Cylinder

1. Fill the reservoirs.
2. Depress the brake pedal several times quickly. And then, with the brake pedal depressed, open the bleeder valve to expel the air. Close the valve before releasing the pedal.
3. Repeat above operation until the brake fluid is expelled in a solid stream, without any air bubbles.

10-F. PARKING BRAKE

Parking Brake Adjustment

Adjust the parking brake as follows.

1. After adjusting the rear brake, adjust the adjusting nut of the equalizer so that the brake begins to apply when pulling the parking brake lever two or three notches.

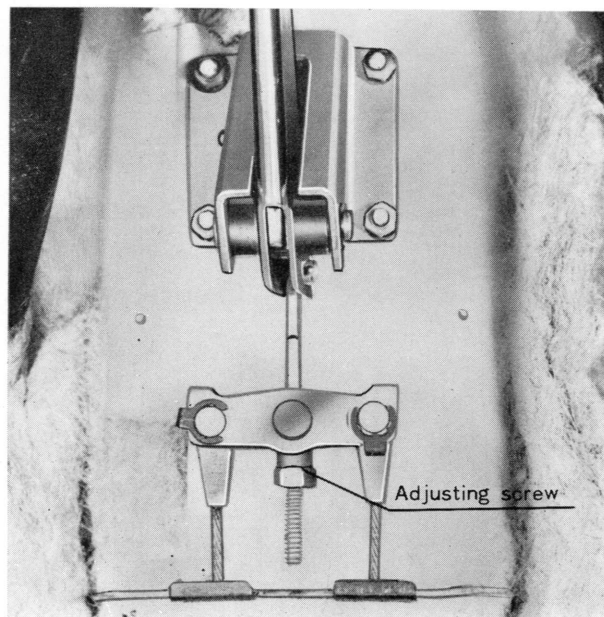

Fig. 10-29 Adjusting parking brake

SPECIAL TOOLS

49 0221 600B Expanding tool

STEERING

11-A. CHECKING THE STEERING WHEEL PLAY ...	11 : 1
11-B. REMOVING THE STEERING GEAR.....	11 : 1
11-C. DISASSEMBLING THE STEERING GEAR.....	11 : 2
11-D. INSPECTING THE STEERING GEAR.....	11 : 2
11-E. ASSEMBLING THE STEERING GEAR.....	11 : 2
11-F. ADJUSTING THE STEERING GEAR.....	11 : 3
11-F-1. Adjusting the Worm Bearing Preload.....	11 : 3
11-F-2. Adjusting the Sector Gear and Ball Nut Backlash...	11 : 3
11-G. INSTALLING THE STEERING GEAR.....	11 : 3
11-H. STEERING GEAR OIL	11 : 3
11-I. STEERING LINKAGE	11 : 3
11-I-1. Checking the Ball Joints.....	11 : 3
11-I-2. Greasing the Steering Linkage.....	11 : 3
11-I-3. Idler Arm	11 : 4
11-I-4. Replacing the Tie Rod	11 : 4
11-I-5. Replacing the Center Link...	11 : 4
11-J. FRONT WHEEL ALIGNMENT.....	11 : 5
11-J-1. Inspection Before Checking Front Wheel Alignment...	11 : 5
11-J-2. Toe-in	11 : 5
11-J-3. Camber	11 : 5
11-J-4. Caster	11 : 5
11-J-5. Adjusting the Steering Angle	11 : 5
11-J-6. Correcting the Front wheel Alignment...	11 : 5

STEERING

The steering system consists of the steering gear, steering column, steering wheel, and the steering linkage. The steering gear is of the recirculating ball nut type. This steering gear provides easy steering with a minimum of friction in the steering gear.

11-A. CHECKING THE STEERING WHEEL PLAY

The free play at the outer circumference of the steering wheel should be 15~25mm. (0.6~1.0 in.). To check the free play of the steering wheel, face the front wheels straight ahead and turn the steering wheel slowly. The value of the free play is taken when the front wheels begin to move. If excessive play is found, the following points should be carefully

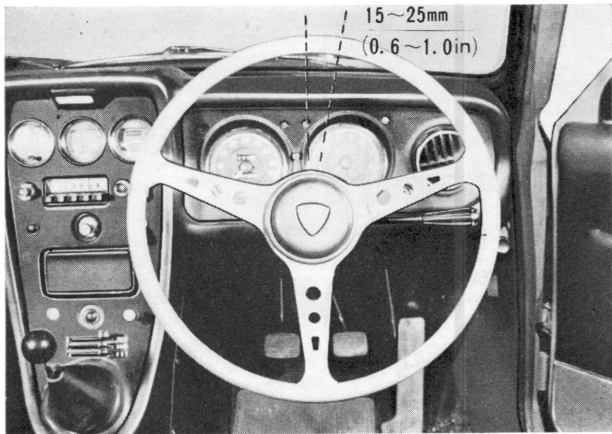

Fig. 11-1 Steering wheel play

checked, because this could cause steering instability when driving.

1. Fit of the ball joints of the drag link and those of the tie rod.
2. Looseness of the wheel bearings.
3. Backlash between the sector gear and ball nut.

11-B. REMOVING THE STEERING GEAR

1. Loosen the worm shaft securing bolt.

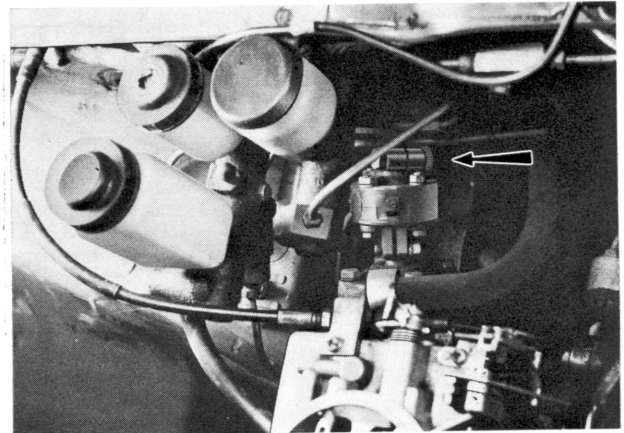

Fig. 11-2 Worm shaft securing bolt

2. Pull out the lights and horn lead wirings from the coupler on the instrument panel.
3. Pull the steering wheel and disconnect the steering joint from the worm shaft. Take out the spring

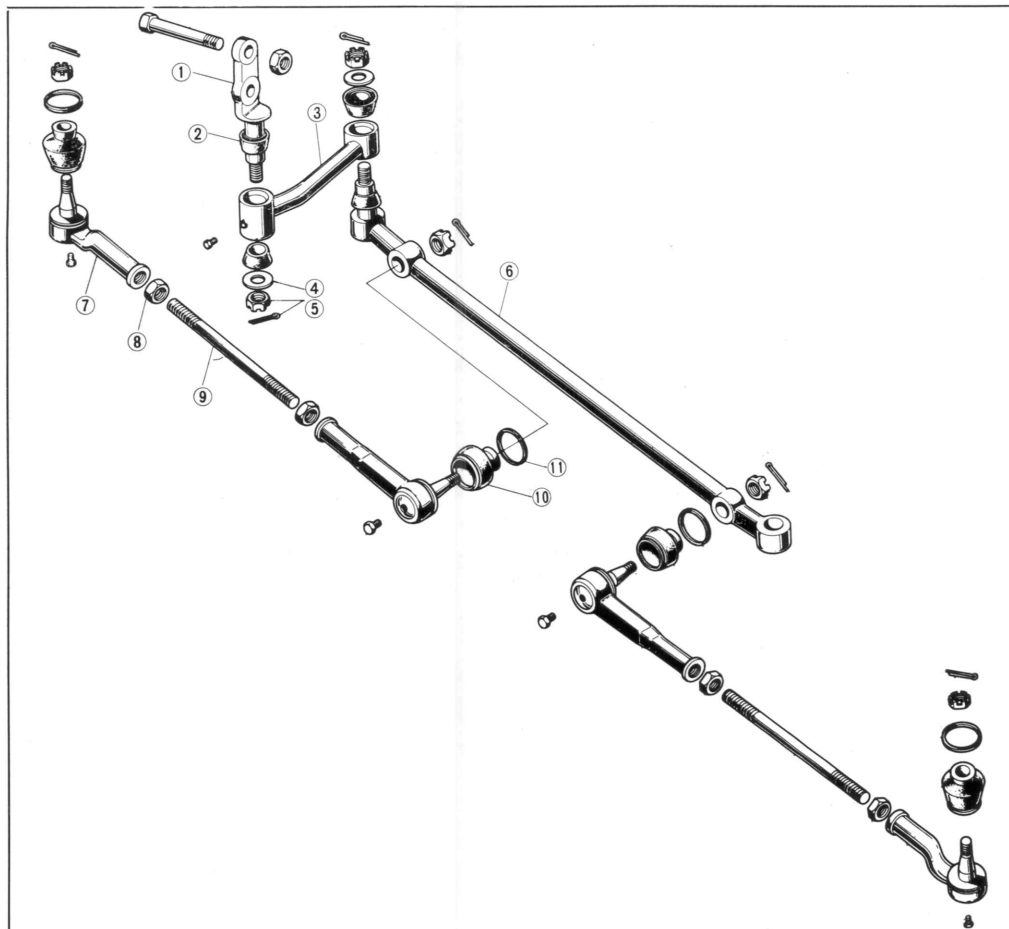

Fig. 11-3

Steering linkage

1. Spindle
2. Taper bush
3. Idler arm
4. Washer
5. Nut and split pin
6. Center link ass'y
7. Socket ass'y
8. Lock nut
9. Tie rod
10. Dust seal
11. Set ring

Fig. 11-3

from the steering joint.

4. Jack up the vehicle and remove the wheel.
5. Disconnect the center link from the pitman arm by using a **ball joint puller** (49 0118 850B).
6. Remove the bolts and nuts supporting the gear housing to the frame. Remove the steering gear from the vehicle.

Note: *Confirm the position of the shim for convenience when readjusting the column shaft alignment.*

11-C. DISASSEMBLING THE STEERING GEAR

Before disassembling thoroughly clean the outside of the steering gear housing.

1. Drain oil by removing the plug.
2. Unscrew the nut holding the pitman arm and remove the pitman arm with a suitable extractor.
3. Remove the sector shaft adjusting screw lock nut.
4. Unscrew the side cover bolts and remove the side cover and gasket by turning the adjusting screw clockwise through the cover.

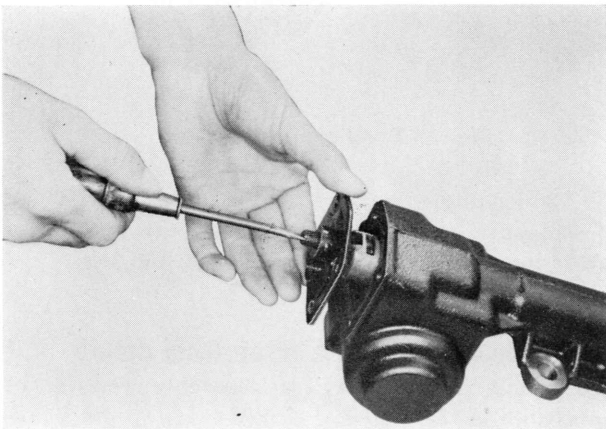

Fig. 11-4 Removing side cover

5. Remove the adjusting screw and shims from the slot at the end of the sector shaft.
6. Remove the sector shaft from the gear housing with care so as not to damage the oil seal.
7. Remove the end cover and shims by unscrewing the bolts.
8. Remove the worm shaft and ball nut assembly through the bottom of the gear housing.

11-D. INSPECTING THE STEERING GEAR

1. Check operation of the ball nut assembly on the worm shaft. If the ball nut does not travel smoothly and freely on the worm shaft and there is roughness, the ball nut and worm shaft assembly should be replaced.

Note: *The worm shaft and ball nut are serviced as an assembly only.*

2. Check the bearings for wear, looseness or any damage.
3. Check the oil seal for wear, flaws, or any damage. If there is any possibility of oil leakage, replace the oil seal.

11-E. ASSEMBLING THE STEERING GEAR

1. Insert the worm shaft and ball nut assembly into the gear housing.
2. Install the end cover with the shims, and adjust the bearing preload to 1.0~4.0 cm·kg (0.8~3.4 in·lb), by following the procedure explained in Par. 12-F-1.

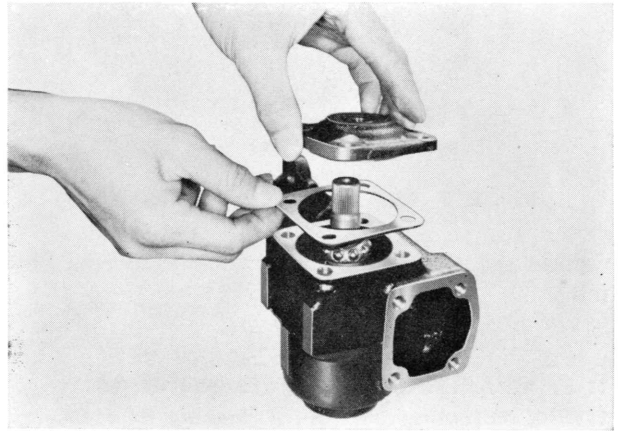

Fig. 11-5 Fitting end cover and shims

3. Install the adjusting screw into the slot at the end of the sector shaft. Check the end clearance with a feeler gauge, as shown in Fig. 11-6, and adjust this clearance to 0.02~0.08 mm. (0.0008~0.0031 in.) by inserting appropriate shims. The shims are available in the following four thicknesses:

- | | |
|----------------------|----------------------|
| 1.95 mm. (0.077 in.) | 2.05 mm. (0.081 in.) |
| 2.00 mm. (0.079 in.) | 2.10 mm. (0.083 in.) |

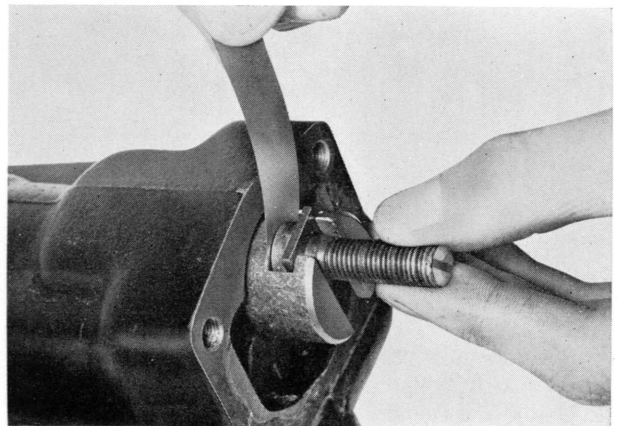

Fig. 11-6 Checking end clearance

4. Turn the worm shaft and place the rack in the center position of the worm. Insert the sector shaft and adjusting screw into the gear housing, being careful not to damage the oil seal, and ensuring that the center of the sector gear is aligned with the center of the rack as shown in Fig. 11-7.

5. Place the side cover and the gasket on to the adjusting screw and turn the adjusting screw counter-clockwise until it is screwed into proper position.
6. Install the side cover bolts.
7. Adjust the backlash between the sector gear and rack by applying the procedure explained in Par. 12-F-2. Tighten the adjusting screw lock nut securely.
8. Install the pitman arm onto the sector shaft and

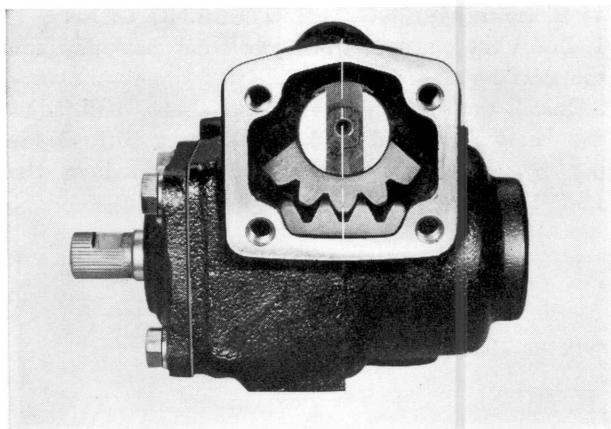

Fig. 11-7 Align center of rack and sector gear

tighten the nut. Tightening torque is 14 m·kg (100 ft·lb)

11-F. ADJUSTING THE STEERING GEAR

11-F-1. Adjusting the Worm Bearing Preload

To adjust the worm bearing preload, remove the steering gear from the vehicle. Rotate the worm shaft with a torque wrench and check the torque. The rotating torque (preload) should be between 6.0 ~ 8.0 cm·kg (5.2 ~ 6.9 in·lb)

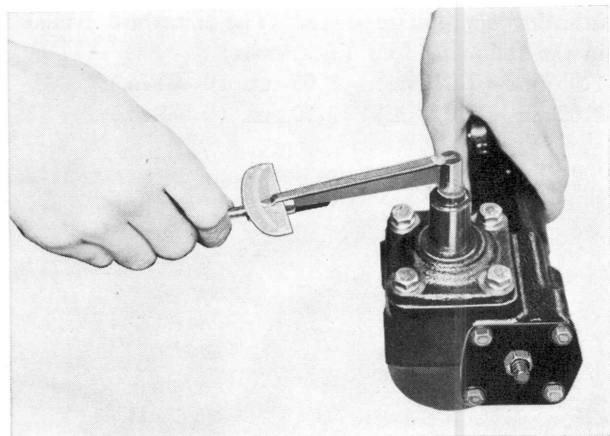

Fig. 11-8 Checking preload

If the reading is not within these limits, adjust the preload as follows:

1. Unscrew the end cover bolts and remove the end cover with shims.
2. If the preload is less than 6.0 cm·kg (5.2 in·lb), reduce the shim, add a shim if the preload is more than 8.0 cm·kg (6.9 in·lb).

The following shims are available:

0.050 mm. (0.020 in.)	0.100 mm. (0.004 in.)
0.075 mm. (0.003 in.)	0.200 mm. (0.008 in.)

3. Install the end cover and recheck the preload.

Note: The preload before installing the sector shaft should be between 1.0 ~ 4.0 cm·kg (0.8 ~ 3.4 in·lb).

11-F-2. Adjusting the Sector Gear and Ball Nut Backlash

The adjusting screw on the side cover raises or lowers the sector shaft to provide proper meshing of the

tapered teeth of the sector gear and the rack of the ball nut. This adjustment can be accurately made only after proper worm bearing preload has been established.

Adjust the backlash as follows:

1. Turn the worm shaft slowly and stop at the center position.
2. Loosen the lock nut of the adjusting screw and turn the adjusting screw until correct adjustment is obtained. The backlash should be 0. This is equivalent to a movement of about 2 degrees on the worm shaft.

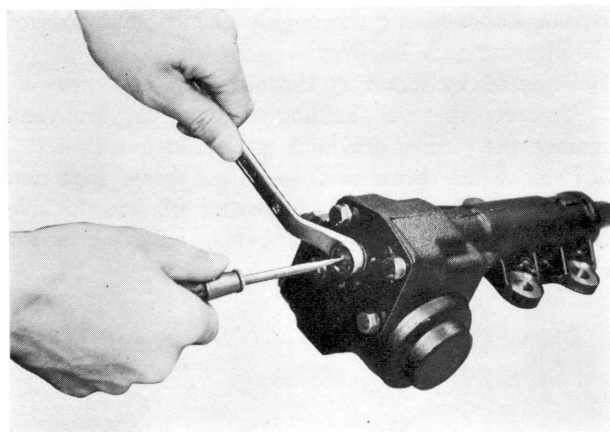

Fig. 11-9 Adjusting backlash

3. Tighten the adjusting screw lock nut.
4. Rotate the worm shaft and ensure that the sector shaft turns smoothly 40° to the right and left.

11-G. INSTALLING THE STEERING GEAR

To install the steering gear assembly, reverse the procedure in Par. 11-B.

Note: To protect from the rust, coat the grease on the spring which should be installed into the steering joint.

11-H. STEERING GEAR OIL

Oil SAE. EP 90 should be used for the steering gear during both summer and winter. The oil is supplied from the filler hole, with the steering gear installed in the vehicle, until the oil overflows from the filler hole. Check the steering gear oil every 18,000 km (12,000 miles) and top up if necessary.

11-I. STEERING LINKAGE

11-I-1. Checking the Ball Joints

1. Check the dust seals for wear, flaws, or any damage. If the dust seals are defective, this will allow entry of water and dirt and result in ball joint wear.
2. The end play of the ball stud is preadjusted at the factory to be between 0 ~ 0.20 mm. (0 ~ 0.008 in.). Check the end play and if it exceeds 0.5 mm. (0.020 in.), replace the ball joint in its assembled form.

11-I-2. Greasing the Steering Linkage

The ball joints of the steering linkage are designed

for maintenance free operation for 48,000 km (30,000 miles). Therefore, no greasing is necessary during this period. When greasing of the ball joints becomes necessary, proceed as follows:

1. Before supplying grease, check the dust seal and the dust seal set ring for any dislocation, deterioration of quality, crack, or damage. These defects will quicken the wear on the ball joint due to entry of dust, water, etc. Therefore, if these defects are found, replace with new ones immediately.

2. Remove the set ring from the groove on the dust seal and turn the dust seal inside out.

3. Remove the plug and fit the grease nipple in its tap hole. Remove all of the used grease in the socket and the dust seal by gradually supplying new lithium grease through the grease nipple.

4. When the used grease is thoroughly removed, fit the dust seal to the groove on the socket and secure it in place with the set ring.

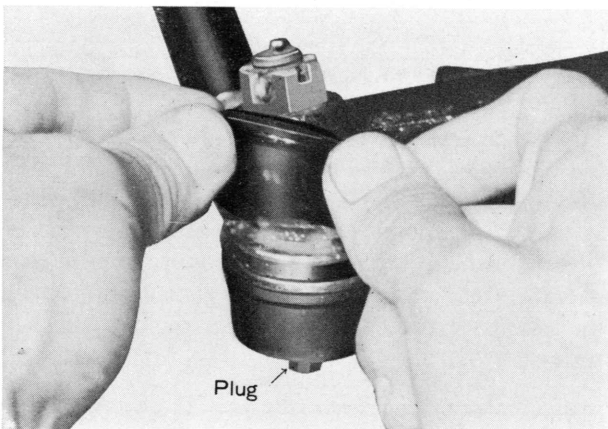

Fig. 11-10 Removing used grease

5. Add new grease until the dust seal begins to balloon. Then, depress the dust seal with the fingers so that about half of the grease remains in the dust seal.

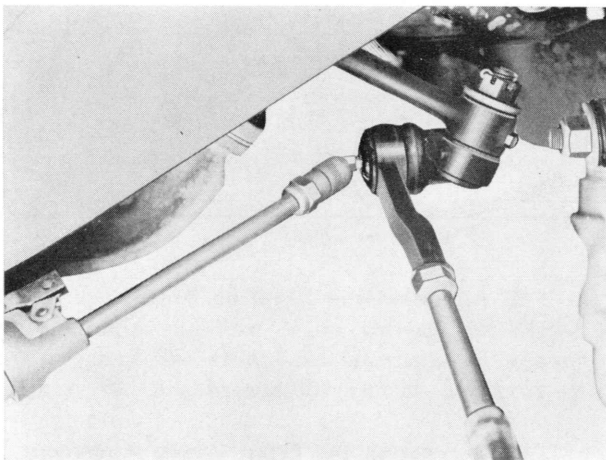

Fig. 11-11 Greasing ball joint

6. Wipe off excess grease around the ball joint. Special care should be taken, as excessive greasing may cause the dust seal to come off while the vehicle is in operation.

7. Remove the grease nipple and fit the plug.

11-I-3. Idler Arm

1. Checking the Idler Arm

After disconnecting the center link from the idler arm, the idler arm can be removed by removing the nuts attaching the idler arm to the side frame. Excessively worn bushes must be replaced. Install the idler arm and tighten the nut to 4.5~5.7 m-kg (32~40 ft-lb).

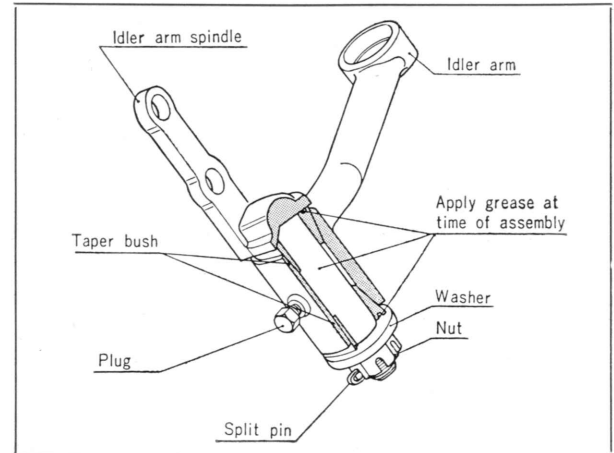

Fig. 11-12 Idler arm assembly

2. Greasing the Idler Arm

When lubricating, remove the plug and temporarily install the grease nipple. Loosen the nut that holds the idler arm to the bracket, and then, feed **lithium grease** until the grease appears from the brim of the bush. Remove the grease nipple and reinstall the plug.

11-I-4. Replacing the Tie Rod

The tie rod can be removed from the center link and knuckle arm by removing the ball joint nut and using the **ball joint puller** (49 0118 850B). Install the tie rod to the center link and steering knuckle. Whenever the tie rods or ball joints are replaced, toe-in must be reset.

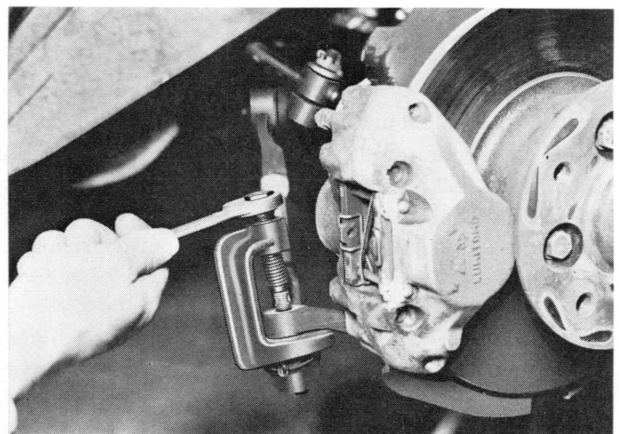

Fig. 11-13 Removing ball joint

11-I-5. Replacing the Center Link

The steering center link can be removed from both tie rods, pitman arm and idler arm by removing the ball joint nut and using the **puller** (49 0118 850B). The center link can be replaced by installing a new

one and connecting it to the pitman arm, idler arm and tie rods.

11-J. FRONT WHEEL ALIGNMENT

11-J-1. Inspection Before Checking Front Wheel Alignment

Proper alignment of front wheels must be maintained in order to insure safe steering and satisfactory tire wear. Before checking or correcting front wheel alignment, the following points which affect steering should be inspected.

1. Check the tire inflation and bring to the recommended pressure.
2. Inspect the front wheel bearing adjustment and correct, if necessary.
3. Inspect the wheel and tire deflection and balance.
4. Inspect the ball joints of the front suspension and steering linkage for excessive play.
5. The vehicle must be on a level floor and without luggage or passenger load.

11-J-2. Toe-in

Toe-in is the difference in the distance between the front wheels, measured at the front and at the rear of the tires and is 1.0 ~ 3.0 mm. (0.04 ~ 0.12 in.). Toe-in is necessary to offset the effect of camber.

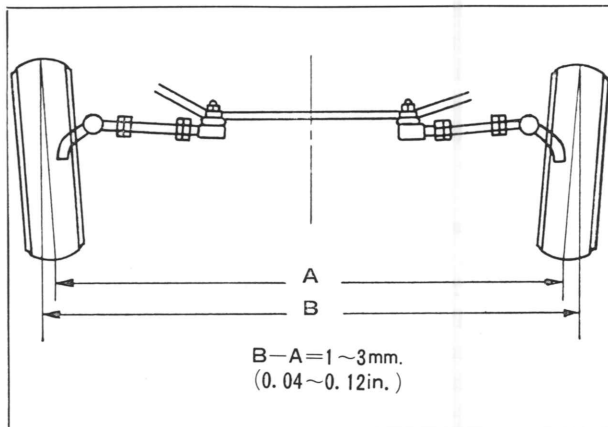

Fig. 11-14 Toe-in

Check and adjust the toe-in as follows:

Raise the front of the vehicle until the wheels are off the ground. Turning the wheels by hand, mark a line in the center of the each tire tread by using a scribing block. Measure the distances between the marked lines at the front and rear of the wheels. Both measurements must be taken at equal distances from the ground. If the distance between the wheels at the rear is greater than that at the front by 1.0 ~ 3.0 mm (0.04 ~ 0.12 in.), it is correct. If it is found to be incorrect, adjust the toe-in by loosening the lock nut and turning the tie rods. One complete turn of the tie rod alters the toe-in to the amount of 12 mm. (0.5 in.)

11-J-3. Camber

Camber is the vertical outward tilting of the front wheels at the top from the vertical as shown in Fig. 11-15. The standard camber angle is $0^{\circ}59'$. The purpose of camber is to place the weight of the

vehicle, as nearly as possible, directly above the tire surface contacting the road to facilitate an ease of steering. Excessive camber tends to cause uneven wear of the tires, and negative camber hard steering and possibly wandering conditions. Tires then wear out at the inside shoulders.

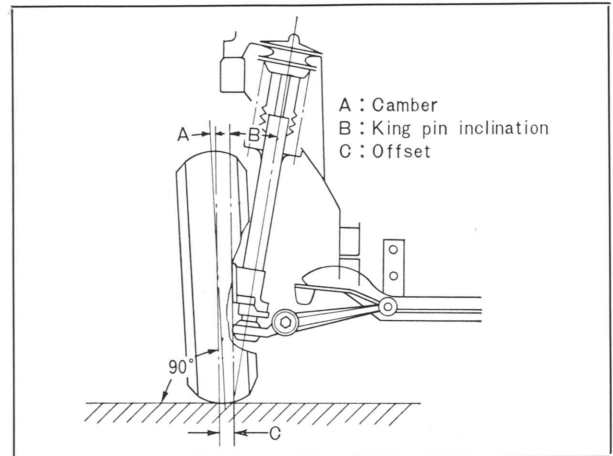

Fig. 11-15 Camber

11-J-4. Caster

Caster is the inclination of the upper ball joint towards the rear of the vehicle. The standard caster angle is 2° . The purpose of the caster is to provide steering stability by keeping the front wheels in a straight ahead position and also assisting in returning the wheels to straight ahead when coming out of a turn.

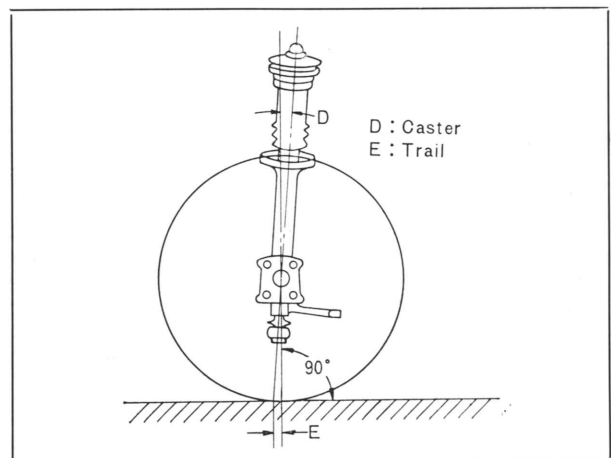

Fig. 11-16 Caster

11-J-5. Adjustment the Steering Angle

Adjust the steering angle with the adjusting bolts fitted onto the pitman arm and the side frame, so that the front wheels turn 40° inward and 30° outward.

11-J-6. Correcting the Front Wheel Alignment

The front wheel alignment, due to its structure, will change if the position of the suspension upper support is changed. Thus if, through a collision or other accidents, the front fender should become deformed, the relative positions of the front fender side frame and the suspension upper support mounting must be restored properly to their original positions. When

restoring these to their original positions, use the **tire house setting tool** (49 0259 845) and make the corrections in the following manner :

1. Preparation before using the tire house setting tool
 - 1) Dismount the complete engine from the vehicle.
 - 2) Remove the front suspension together with the front cross member.
 - 3) Make corrections on the side frame beforehand in accordance with the FRAME CHECKING DIMENSION (for MAZDA R 100 coupé) in section 14.

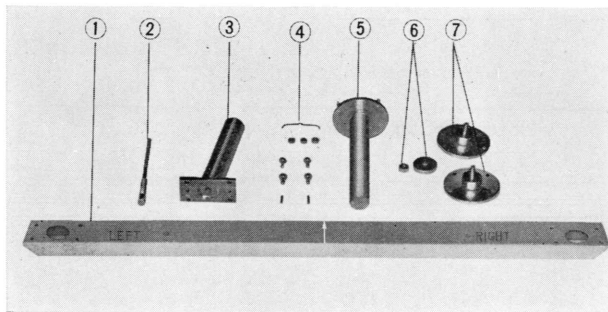

Fig. 11-17 Tire setting tool

- | | | |
|-------------------|-----------------|----------------|
| 1. Datum base | 4. Bolt & nuts | 7. Angle plate |
| 2. Adjusting bolt | 5. Slide post | |
| 3. Datum post | 6. Washer & nut | |

2. Installing the tire house setting tool and checking

- 1) Install the datum base onto the rear bolt of the side frame cross member mounting bolts. Ensure that the right and left sides of the base are properly set as seen from the rear of the vehicle.

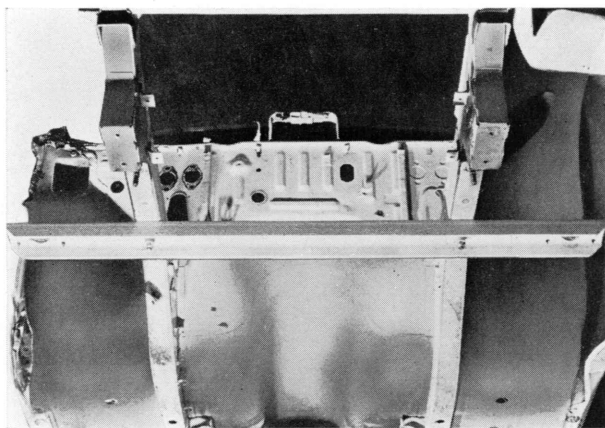

Fig. 11-18 Installing tire setting tool

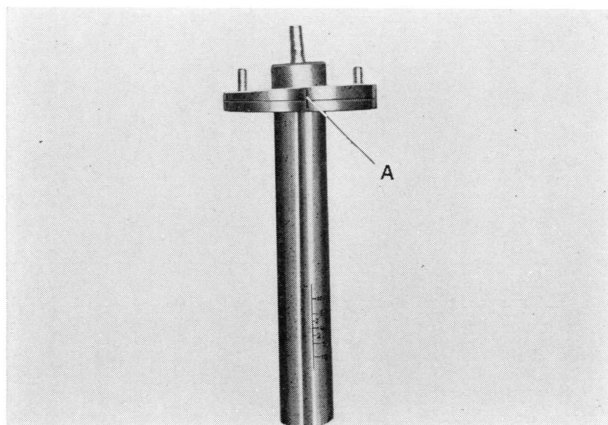

Fig. 11-19 Installing angle plate

- 2) Intall the angle plate (right or left) corresponding to the side to be corrected onto the slide post so that it is in line with A as shown in Fig. 11-19.
- 3) Install the slide post onto the datum post.
- 4) Align the knock pin on the datum post with the knock pin hole on the datum base and secure with bolts in four places.

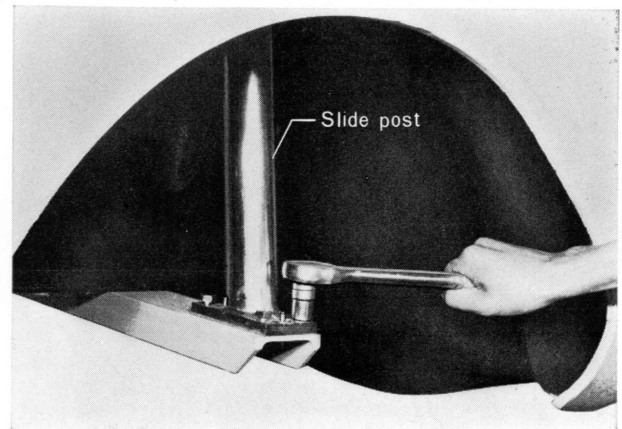

Fig. 11-20 Installing slide post

- 5) Raise the slide post with the adjusting bolt from under the datum post and set into position by inserting the three bolts on the angle plate into the bolt holes on the upper support of the wheel apron panel. If the angle of inclination on the upper support coincides with that on the angle plate and the readings on both the slide post and the datum post are zero, the distance between the lower end of the side frame and the upper support may be considered as being satisfactory. The standard distance between these two points is 450 mm ± 2 (17.7 in. ± 0.08).

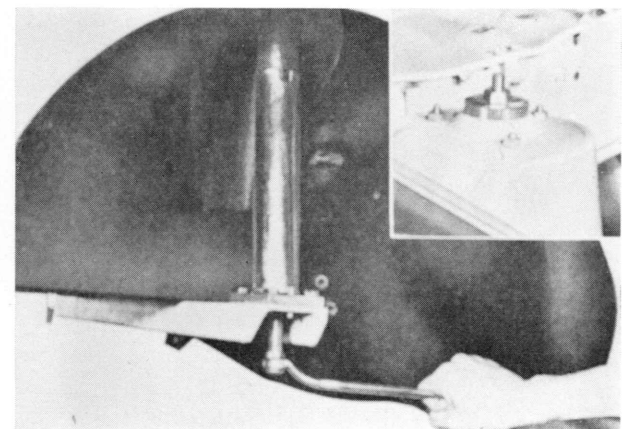

Fig. 11-21 Raising slide post

If the readings on both the slide post and the datum post do not come to zero, remove the tire house setting tool and, in the case the sheet metal or the upper support assembly has been replaced, renew the weld so that the readings will become zero.

3. Replacing the wheel apron panel

Install the tire house setting tool in the same manner as the above. Set the height of the slide post at 450 mm. (17.7 in.) and secure the wheel apron panel onto the tool with bolts. Bring the wheel apron panel into proper position by aligning it to the tool

and, after securing it with hand vices, weld into position.

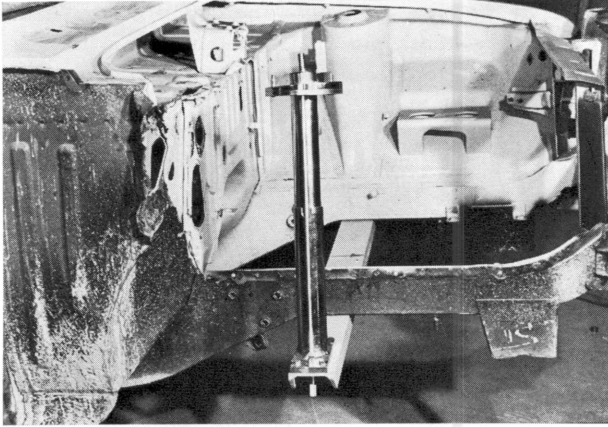

Fig. 11-22

SPECIAL TOOLS

49 0118 850B	Ball joint puller
49 0259 845	Tire house setting tool

WHEEL AND TIRES

12-A. INFLATING THE TIRES	12 : 1
12-B. TIRE ROTATION	12 : 1
12-C. CHANGING THE WHEELS	12 : 1
12-D. WHEEL AND TIRE RUNOUT	12 : 1
12-E. WHEEL BALANCING	12 : 1
12-F. FRONT WHEEL BEARINGS	12 : 1
12-F-1. Checking the Front Wheel Bearings	12 : 1
12-F-2. Removing the Front Wheel Bearings	12 : 2
12-F-3. Installing the Front Wheel Bearings	12 : 2
12-F-4. Front Wheel Bearing Adjustment	12 : 2

WHEELS AND TIRES

12-A. INFLATING THE TIRES

Maintenance of correct tire pressure is one of the most important elements of tire care.

Excessive inflation will cause :

1. Hard rides
2. Damage to tire carcass
3. Poor traction
4. Premature tread wear in center of tire

Low inflation will cause :

1. Hard steering
2. Rapid and uneven wear on the edges of tire tread
3. Increased cord fatigue or broken tire cords
4. High tire temperature
5. Blow outs

Check the inflation pressure with a reliable gauge when the tires are cold. The standard pressure is as follows :

	Tire size	Inflation pressure
Front Wheel	145 SR 14	1.8 kg/cm ² (26 lb/in)
Rear Wheel	145 SR 14	1.8 kg/cm ² (26 lb/in)

After checking or increasing the pressure, place the valve cap back and tighten with fingers. It helps to maintain the air pressure in the tires in case of valve leaking and keeps dust and water out of the valve.

12-B. TIRE ROTATION

To equalize wear and to obtain longer tire life, it is recommended that the tires be rotated as shown in Fig. 12-1, every 6,000 km (4,000 miles). When rotating the tires, check for signs of abnormal wear, bulging or any attached stones, nails, glass, etc.

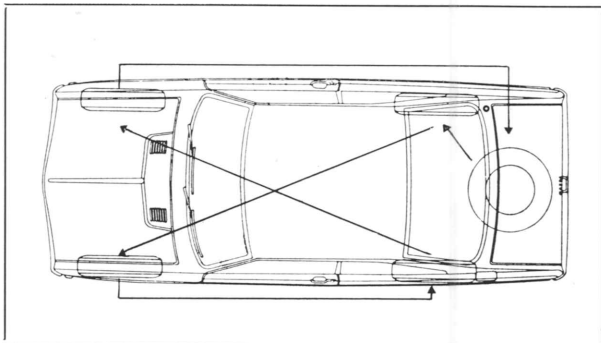

Fig. 12-1 Tire rotation

12-C. CHANGING THE WHEELS

1. Apply the parking brake and block the front and back of the wheel with wheel stoppers.
2. Remove the hub cap and loosen the hub nuts. All hub nuts are right handed screws which are loosened by turning counter-clockwise.
3. Use the spare tire clamp-seat as a jack stand. Support the concave part under the bumper and lift

up the vehicle by turning the jack handle clockwise until the wheels are off the ground.

4. Remove the wheel attaching nuts and change wheels.
5. Install the wheel attaching nuts and tighten diametrically opposite in turn so that the wheel is in even contact with the hub flange.
6. Lower the vehicle, and retighten the nuts to 9.5 m-kp (68.4 ft-lb) evenly.
7. Refit the hub cap.

12-D. WHEEL AND TIRE RUNOUT

Wheel and tire should be measured for both radial and lateral runout. The radial runout is the difference between the high and low points on the tread of tire; while the lateral runout is the wobble of the wheel. To measure the radial runout, apply a dial indicator against the center rib of the tire tread and rotate the wheel slowly. This measurement should not exceed 2.0 mm. (0.08 in.). To measure the lateral runout, position a dial indicator against the side of the tire. The reading of the indicator should be within 2.5 mm. (0.10 in.).

12-E. WHEEL BALANCING

The allowable unbalance is 360 cm-gr (5.0 in-oz), which is less than 20 gr. (0.7 oz) at the rim. Excessive wheel unbalance causes shimmy at high speed. If unbalance exceeds 360 cm-gr (5.0 in-oz) or when a tire is disassembled for repair, the tire and wheel assembly should be statically and dynamically balanced in accordance with the manufacturer's instructions. When balancing, the amount of weights needed to compensate for static unbalance should be equally divided into two, one each for the inside and outside of the rim. This will eliminate the necessity of adding weights to compensate for dynamic balance.

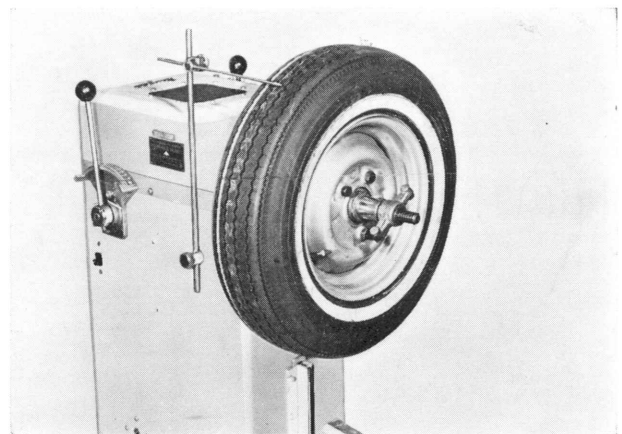

Fig. 12-2 Checking wheel balance

12-F. FRONT WHEEL BEARINGS

12-F-1. Checking the Front Wheel Bearings

To check the front wheel bearings, raise the vehicle with a jack until the wheels clear the ground. Hold the tire and shake it sideways. If considerable play is noticed, this indicates that the bearings are worn.

When disassembled, check the wheel bearings for pits, brinell marks or any damage. If any of the above conditions is found, use new bearings.

12-F-2. Removing the Front Wheel Bearings

1. Raise the vehicle until the front wheel is free off the ground.
2. Remove the hub cap and wheel.
3. Remove the caliper together with the brake fluid hose by loosening the two attaching bolts.
4. Remove the grease cap, split pin and bearing adjusting nut.
5. Remove the outer bearing from the hub.
6. Slide the hub assembly off the spindle.
7. Drive out the oil seal and remove the bearing.

12-F-3. Installing the Front Wheel Bearings

Install the wheel bearings in the reverse order of removing, and observe the following points.

1. Clean the bearings thoroughly and repack them with lithium grease. Do not overpack.
2. Fill the hub cavity with lithium grease.
3. Adjust the bearing preload as described in Par. 12-F-4.

12-F-4. Front Wheel Bearing Adjustment

- 1 Tighten the wheel bearing adjusting nut with a

wrench until the hub begins to turn with a torque of 2~5 cm-kg (1.7~4.3 in-lb). When measuring with a spring scale at the hub bolt, it should be 0.4~0.9 kg, (0.9~2.0 lb).

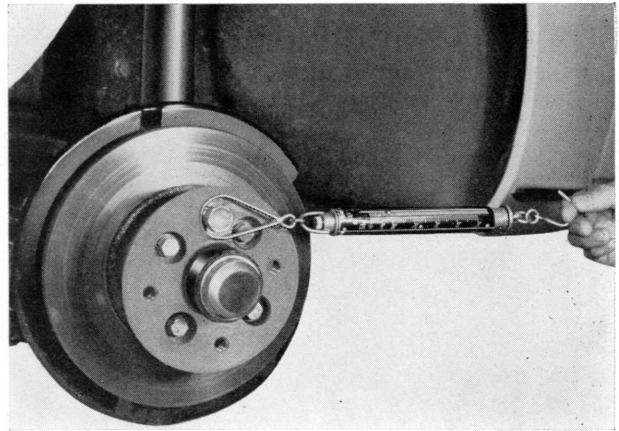

Fig. 12-3 Checking preload

2. Align the split pin slots of the adjusting nut with the pin hole in the spindle and install the split pin.
3. Clean the grease cap, coat the inside with lithium grease and install the cap.
4. Install the caliper, wheel and hub cap.

SUSPENSION

13-A. FRONT SUSPENSION	
(STRUT TYPE).....	13 : 2
13-A-1. Removing the Front	
Suspension.....	13 : 2
13-A-2. Checking the Front	
Suspension.....	13 : 3
13-A-3. Ball Joint	13 : 3
13-A-4. Replacing the Ball Joint	13 : 3
13-A-5. Disassembling the Front	
Shock Absorber.....	13 : 4
13-A-6. Checking the Front	
Shock Absorber.....	13 : 4
13-A-7. Assembling the Front	
Shock Absorber.....	13 : 6
13-A-8. Installing the Front	
Suspension.....	13 : 7
13-B. REAR SUSPENSION	13 : 7
13-B-1. Removing the Rear	
Shock Absorber.....	13 : 7
13-B-2. Checking the Rear	
Shock Absorber.....	13 : 7
13-B-3. Installing the Rear	
Shock Absorber.....	13 : 7
13-B-4. Removing the Rear Spring ...	13 : 7
13-B-5. Checking the Rear Spring.....	13 : 9
13-B-6. Installing the Rear Spring.....	13 : 9

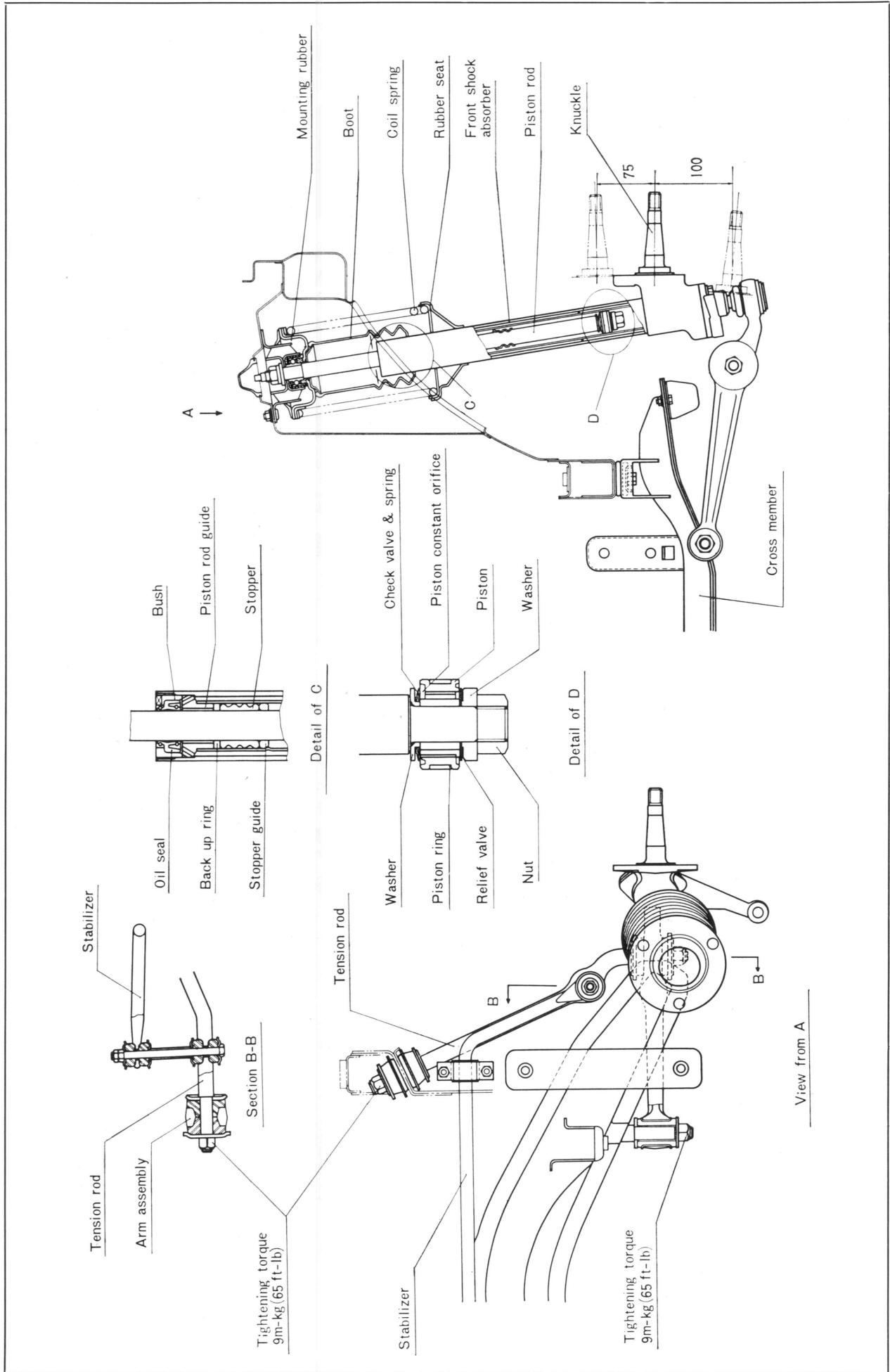

Fig. 13-1 Front suspension (strut type)

13-A. FRONT SUSPENSION (STRUT TYPE)

The main components of the front suspension are the double acting shock absorbers at each steering knuckles, coil springs, tensin rods, suspension arms, and the stabilizer bars as shown in Fig. 13-1. The front shock absorbers installed on MAZDA R100 Coupé front suspension have king pin characteristics in addition to shock absorbing characteristics.

13-A-1. Removing the Front Suspension

1. Jack up the front cross member and remove the front wheels.
2. Disconnect the brake flexible hose from the flexible hose fixing clip of the reservoir tube. Plug the end of the flexible hose to prevent the entrance of the dirt and fluid.
3. Remove the attaching bolts and lift off the caliper.
4. Remove the hub grease cap, split pin and bearing adjusting nut from the spindle.
5. Pull the wheel hub and brake disk assembly off the spindle.
6. Remove the three bolts attaching the mounting rubber to the front fender apron.



Fig. 13-2 Removing bolts

7. Disconnect the stabilizer bar from the tension rod.
8. Disconnect the tie rod end from the steering knuckle arm.
9. Loosen the nuts at both ends of the tension rod.
10. Loosen the suspension arm attaching nut from the rod on the front cross member, and remove the front

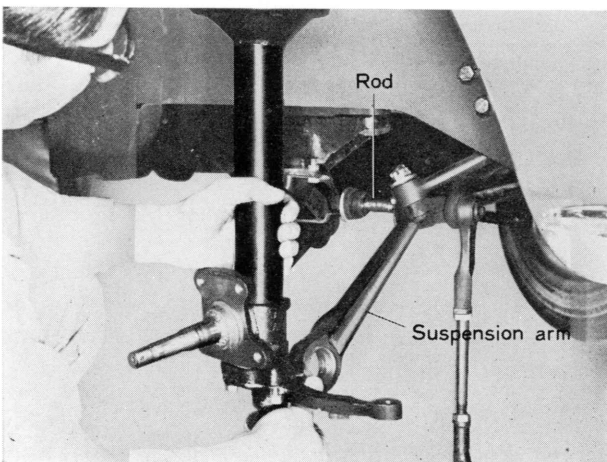

Fig. 13-3 Removing suspension

- shock absorber with the suspension arm assembly.
11. Hold the shock absorber in a vise.
12. Compress the coil spring with the **front suspension coil spring holder** (49 0223 640). Hold the upper end of the piston rod with a spanner and remove the lock nut.

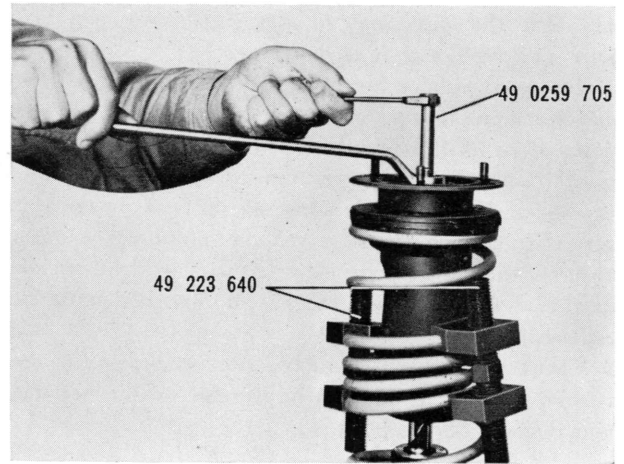

Fig. 13-4 Removing coil spring

13. Remove the washer, mounting rubber, spacer, seal, boot and spring seat upper, rubber seat upper, adjusting plate, and the coil spring in that order.

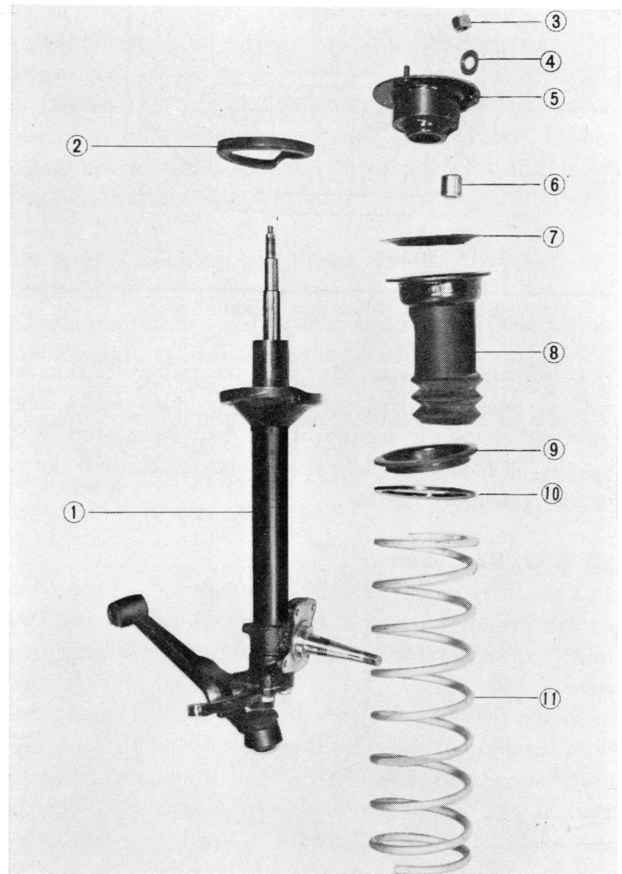

Fig. 13-5 Front suspension assembly

- | | |
|----------------------|-------------------------------|
| 1. Shock absorber | 7. Seal |
| 2. Rubber seat lower | 8. Boot and spring seat upper |
| 3. Lock nut | 9. Rubber seat upper |
| 4. Washer | 10. Adjusting plate |
| 5. Mounting rubber | 11. Coil spring |
| 6. Spacer | |

13-A-2. Checking the Front Suspension

1. Check the suspension component parts for any cracks or damages.
2. Check the rubber bushes for weakness, wear or damage. If necessary, install new ones.
3. Check the coil spring for signs of fatigue, cracks or any damage.
4. Check the dust seal of the suspension arm ball joint and replace if it is defective.
5. To test the shock absorber, hold the shock absorber and work the piston rod four or five times up and down over its full length of travel.
If a strong resistance is felt due to hydraulic pressure, the shock absorber is functioning proper. If there is no resistance or excessively loose motion, the shock absorber should be repaired. If oil is evident outside of the shock absorber, the shock absorber must be repaired.
6. Check the mounting rubber for weakness at the rubber cushion, roughness or damage at the bearing, and damage of the bolts.

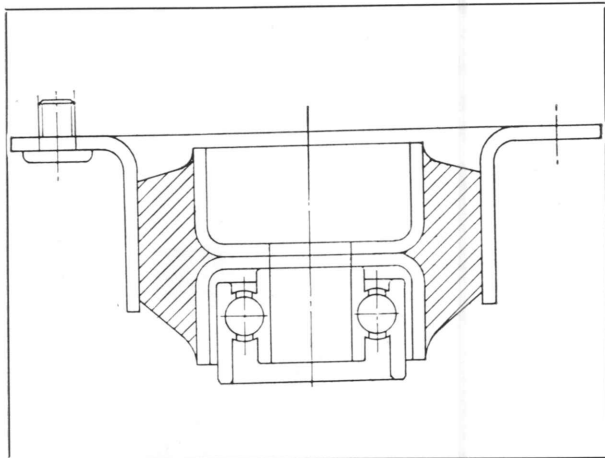

Fig. 13-6 Mounting rubber

7. Check the ball stud play and its radial friction as well as tearing or dislocation of the dust seal. The standard revolving torque of the ball joint stud is 4 kg-cm (30 ft-lb). If defective, replace the ball joint in its assembled form.

13-A-3. Ball Joint

1. The ball joints for the suspension arm on this model are maintenance free for 48,000 km (30,000 miles) and, therefore, requires no greasing during this period.
2. When greasing becomes necessary, supply molybdenum disulfide grease (Lithium grease + more than 3% molybdenum disulfide) to the ball joints, referring to Par. 11-I-2. Never use multipurpose grease or chassis grease. If the wrong grease is used, this will deteriorate the durability of the mechanism.

13-A-4. Replacing the Ball Joint

When it becomes necessary to replace the ball joint, proceed as follows:

1. Loosen the three bolts attaching the knuckle arm, and remove the knuckle arm assembly from the shock absorber reservoir tube assembly.

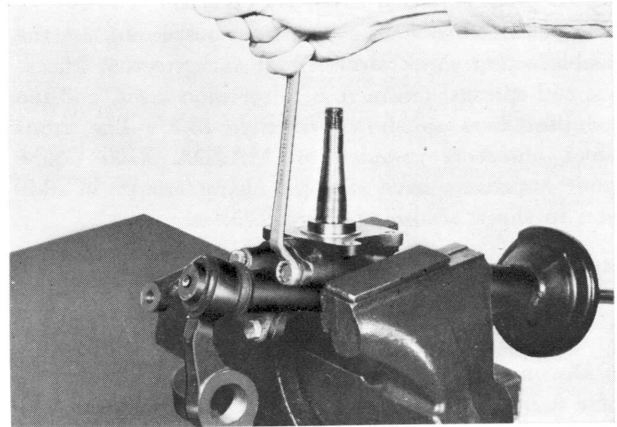

Fig. 13-7 Removing knuckle arm

2. Remove the ball joint nut, and then remove the ball joint and suspension arm assembly from the knuckle arm.
3. Remove the set ring and the dust boot from the ball joint.
4. Using the **ball joint remover and installer** (49 0259 860), press the ball joint out of the suspension arm.

Note: Before pressing out the ball joint, clean the ball joint and suspension arm so as not to damage the mounting bore of the suspension arm.

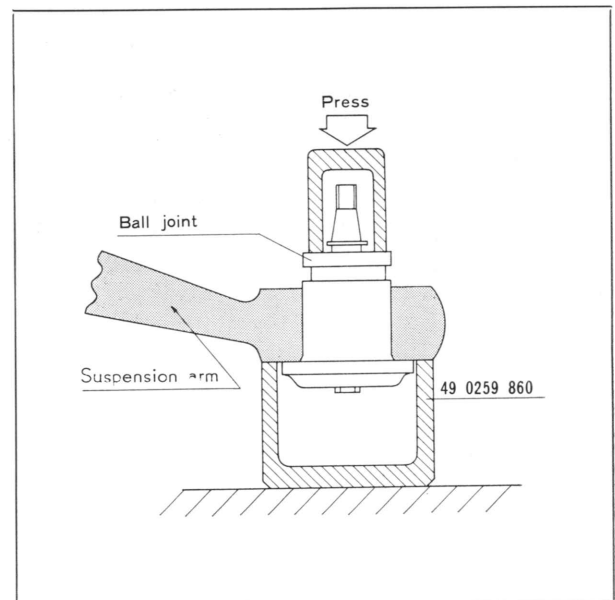

Fig. 13-8 Removing ball joint

5. Clean the mounting bore of the suspension arm and apply kerosene.
6. Press fit the ball joint to the suspension arm with the **ball joint remover and installer** (49 0259 860). Refer Fig. 13-9.

Note: If the pressure necessary to press in the ball joint is less than 1.500 kg (3.300 lb), the suspension arm should be replaced.

7. Install the ball joint and suspension arm assembly to the knuckle arm and tighten the nut to 9 m-kg (6.5 ft-lb).

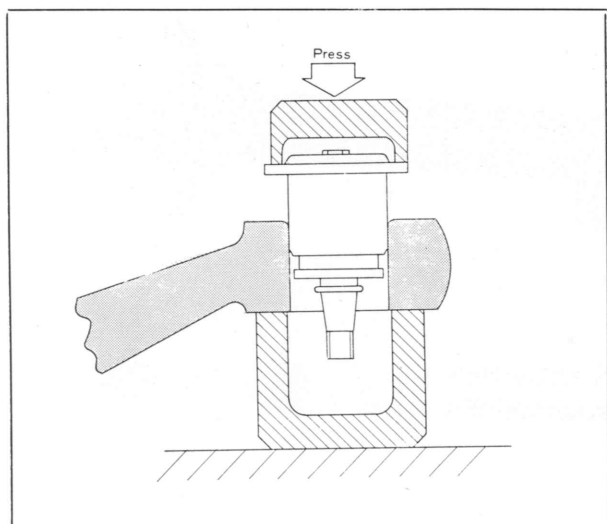

Fig. 13-9 Installing ball joint

13-A-5. Disassembling the Front Shock Absorber

1. Clamp the reservoir tube in a vise equipped with the soft jaws.
2. Remove the bolts attaching the knuckle arm to the shock adsorber and remove the knuckle arm.
3. Flatten the upper end of the reservoir tube which is caulked, and remove the cap nut and seal from the reservoir tube by using the **cap nut wrench** (49 0259 700).

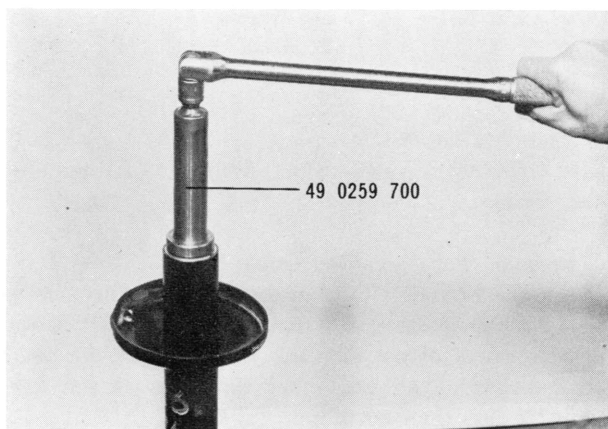

Fig. 13-10 Loosening cap nut

4. Remove the "O" ring installed on the piston rod guide with a suitable tool.



Fig. 13-11 Removing "O" ring

5. Take out the pressure tube together with the piston rod assembly from the reservoir tube.
6. Remove the bottom valve assembly from the bottom of the pressure tube. And then take out the piston rod assembly.
7. Remove the piston rod guide, back up ring, stopper and the stopper guide from the pressure tube.
8. Disassemble the piston rod assembly.
 - 1) Install the upper end of the piston rod or the A of the piston rod in a vise, and loosen the nut.

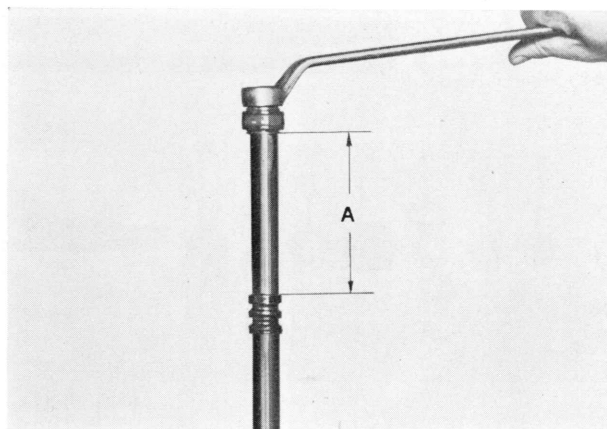

Fig. 13-12 Removing piston

- 2) Remove the washer, relief valves, piston, check valve, check valve spring, and the washer from the piston rod.
9. Loosen the bolt and the nut of the bottom valve assembly, and remove the seats, relief valve, orifice valve, check valve, and the check valve spring from the base valve casing.

13-A-6. Checking the Front Shock Absorber

1. Piston Rod

Check the piston rod for wear and scores. The piston rod diameter should be more than 19.94 mm. (0.785 in.). The standard diameter is 20.0 mm. (0.788 in.). Check the deflection of the piston rod by supporting both ends of the piston rod on the V blocks and applying a dial indicator. The allowable deflection is less than 0.15 mm. (0.006 in.).

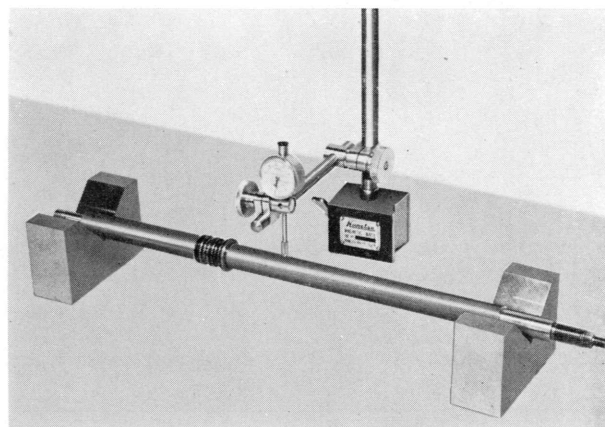

Fig. 13-13 Checking deflection

2. Piston and Piston Ring

Check the contact surface of the piston with the

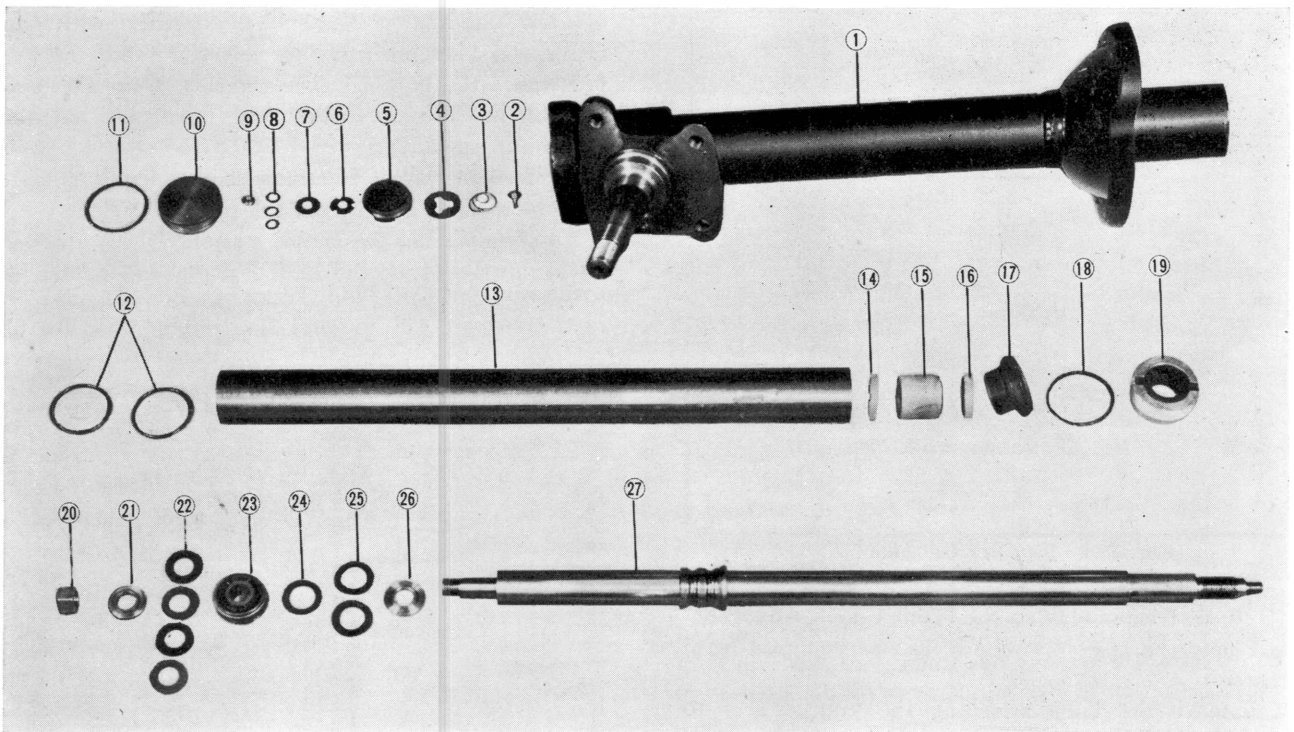

Fig. 13-14 Front shock absorber

- | | | | |
|-----------------------|-------------------|----------------------|--------------------------|
| 1. Reservoir tube | 8. Seal | 15. Stopper | 22. Relief valve |
| 2. Bolt | 9. Nut | 16. Back up ring | 23. Piston & piston ring |
| 3. Check valve spring | 10. Bottom | 17. Piston rod guide | 24. Check valve |
| 4. Check valve | 11. "O" Ring | 18. "O" Ring | 25. Check valve spring |
| 5. Base valve casing | 12. Oil stop ring | 19. Cap nut & seal | 26. Washer |
| 6. Orifice valve | 13. Pressure tube | 20. Nut | 27. Piston rod |
| 7. Relief valve | 14. Stopper guide | 21. Washer | |

check valve and the relief for wear or damage. If excessive wear or damage is found, install a new one. Check the piston ring for wear or damage.

damage and flatness. Check the check valve spring for signs of fatigue or any damage.

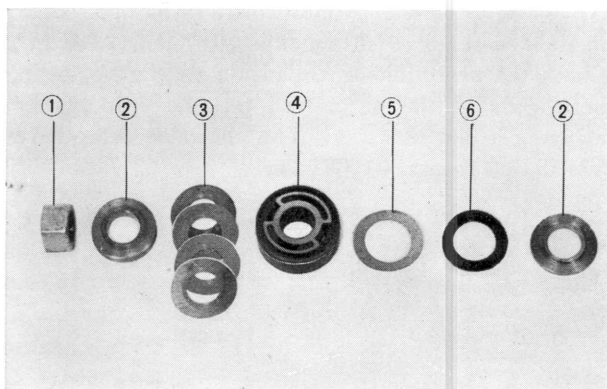

Fig. 13-15 Piston assembly

- | | |
|-----------------|-------------------------|
| 1. Nut | 4. Piston & piston ring |
| 2. Washer | 5. Check valve |
| 3. Relief valve | 6. Check valve spring |

Check the relief valve and the check valve for wear,

3. Pressure Tube and Rod Guide
Check the run-out of the pressure tube. The permissible run-out is under 0.2 mm. (0.008 in.). Check the inner surfaces of the tube and the rod guide for wear or damages. And the inner diameter of the tube should be less than 30.07 mm. (1.184 in.).

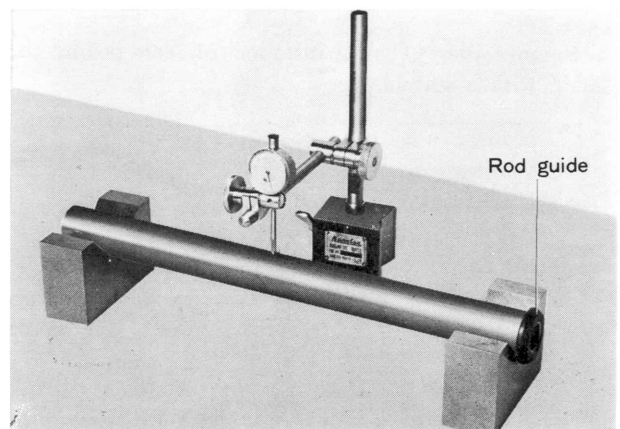

Fig. 13-16 Checking run-out

	Thickness	Flatness
Relief valve	0.15 mm. (0.006 in.)	less than 0.02 mm. (0.0008 in.)
Check valve	0.40 mm. (0.016 in.)	less than 0.02 mm. (0.0008 in.)

4. Cap Nut and Seal
Check the cap nut and seal for damage at the thread, and check the lip of the oil seal for wear or damage.

If necessary, use a new one.

5. Bottom Valve and Bottom

Check the bottom and the "O" ring for wear or damage. Check the check valve spring for signs of fatigue or damage. The standard free length of the check valve spring is 5.5 mm. (0.217 in.).

Check the base valve casing, check valve, relief, orifice valve, and the seat for wear or damage.

	Thickness	Flatness
Check valve	0.4 mm. (0.016 in.)	less than 0.04 mm. (0.020 in.)
Orifice valve	0.2 mm. (0.006 in.)	"
Relief valve	0.2 mm. (0.006 in.)	"
Seat	0.1 mm. (0.004 in.)	less than 0.02 mm. (0.008 in.)

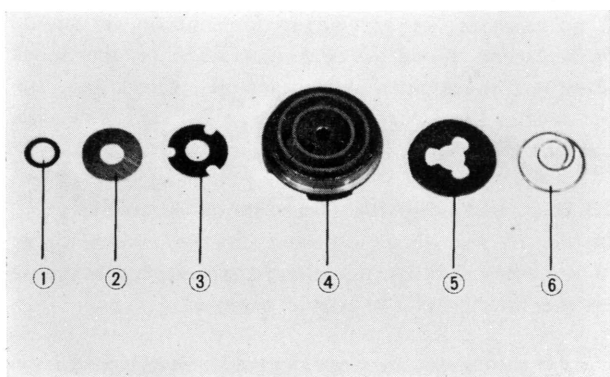

Fig. 13-17 Bottom valve assembly

- 1. Seat
- 2. Relief valve
- 3. Orifice valve
- 4. Base valve casing
- 5. Check valve
- 6. Check valve spring

13-A-7. Assembling the Front Shock Absorber

1. Place the piston rod in a vise equipped with aluminum plates, and install the washer, the check valve spring, the check valve, piston, the four relief valves, the washer, and the nut on the lower end of the piston rod. Tighten the nut to 1.5 m-kg (11 ft-lb), while taking care of the mounting position of the check valve and the check valve springs.

Note: The piston assembly should be fitted with the constant orifice side face toward the upper end of the piston rod.

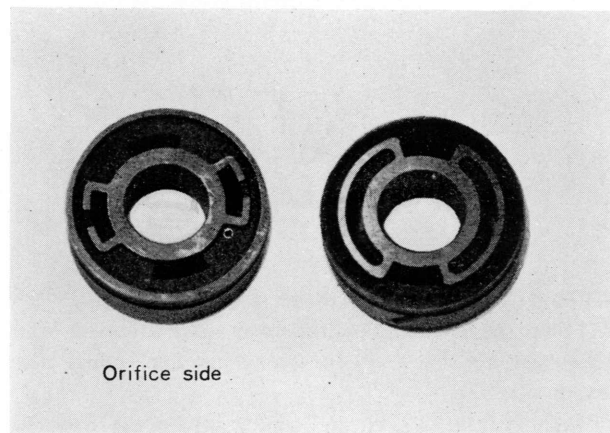

Fig. 13-18 Direction of piston

2. Secure the nut by punch marking two portions of the thread between the nut and the piston rod to prevent loosening of the nut.

3. Assemble the bottom valve assembly.

1) Install the check valve spring and the check valve onto the bolt.

2) Install the bolt in the base valve casing, and install the orifice valve, the relief valve, three seats, and the nut. Tighten the nut to 0.25 m-kg (1.8 ft-lb).

4. After tightening the nut, secure it with a punch mark at the center of the bolt.

5. Insert the stopper guide, stopper, back up ring, and the piston rod guide into the pressure tube.

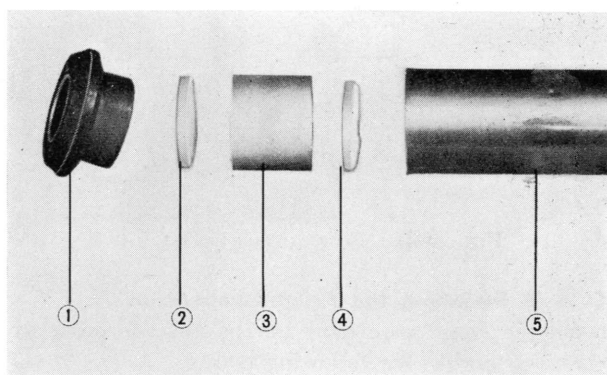

Fig. 13-19 Piston rod guide and stopper

- 1. Piston rod guide
- 2. Back up ring
- 3. Stopper
- 4. Stopper guide
- 5. Pressure tube

Note: Ensure that two oil stop rings fitted on the pressure tube are located in about 60 mm. (2.36 in.) and 130 mm. (5.1 in.) respectively from the base of pressure tube.

6. Insert the piston rod assembly into the pressure tube from the bottom side and insert the bottom valve assembly into the bottom of the pressure tube.

7. Apply a thin coat of sealing agent to the contact surfaces of the reservoir tube and the knuckle arm. Install the knuckle arm to the reservoir tube, and tighten the three bolts to 6.5 m-kg (47 ft-lb).

8. Insert the pressure tube assembly into the reservoir tube.

9. Fill the reservoir tube with shock absorber fluid. The capacity of fluid should be exactly 230 cc (0.49 US pints, 0.43 Imp. pints).

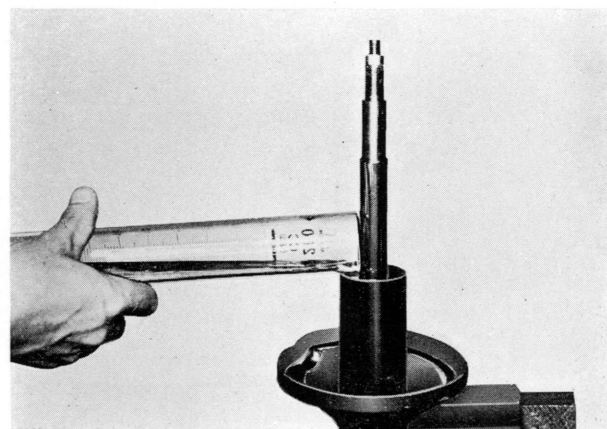

Fig. 13-20 Filling shock absorber fluid

10. Apply grease to the lip of the oil seal. Install the "O" ring and place the cap nut slowly onto the piston rod. Tighten the cap nut to 6.5 m-kg (47 ft.-lb) with the **cap nut wrench** (49 0259 700).
11. After tightening the cap nut, secure it at two portions of the tube with punch marks to prevent loosening of the cap nut.

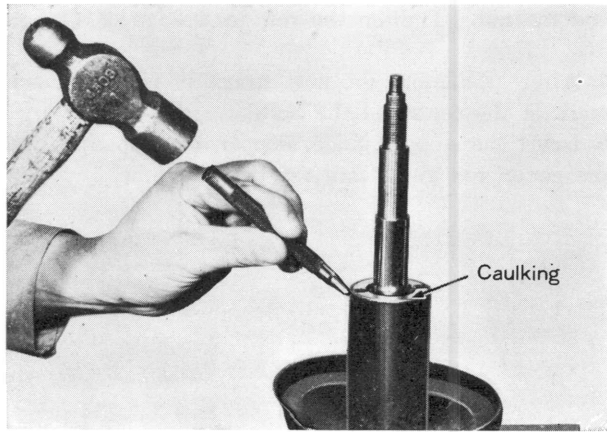

Fig. 13-21 Making punch marks

13-A-8. Installing the Front Suspension

Install the front suspension in the reverse order of removing, noting the following points:

1. Adjust the vehicle height by using the proper combination of the coil spring and adjusting plate. The coil springs are available in three sizes according to the strength of the spring.

Coil Spring Identification	
Mark	Load required to reduce coil spring length from 343 mm. (13.5 in.) to 205 mm. (8.0 in.)
1 dot	246~252 kg (541~554 lb)
2 dots	252~258 kg (554~567 lb)
3 dots	258~264 kg (567~580 lb)

If possible, use spring with the same identification mark on both sides.

2. When installing, use vegetable grease for the interior of the rubber bushes.

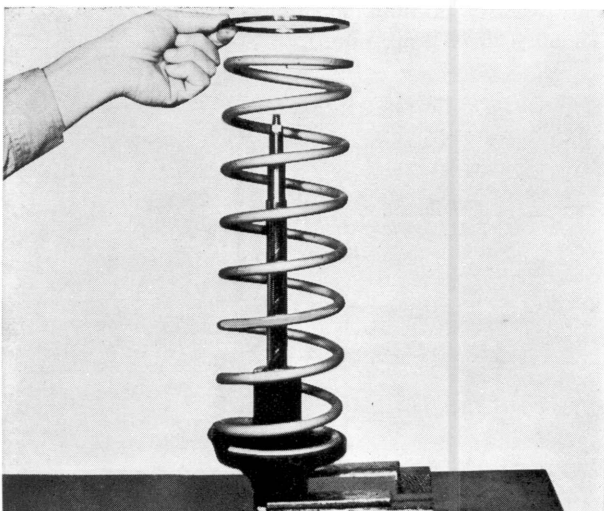

Fig. 13-22 Installing coil spring

13-B. REAR SUSPENSION

The rear springs are of the semi-elliptic type with rubber bushes on the eye of each end of the main leaf. The double acting shock absorbers are fitted with rubber bushes at each end.

13-B-1. Removing the Rear Shock Absorber

1. Remove the rear seat.
2. Remove the nuts, retainers, and rubber bushes from both ends of the shock absorber.
3. Compress the shock absorber and remove it from the vehicle.

13-B-2. Checking the Rear Shock Absorber

To test the shock absorber, hold the shock absorber in an upright position and work it four or five times up and down over its full length of travel. If a strong resistance is felt due to hydraulic pressure, the shock absorber is functioning properly. If there is no resistance or excessively lax motion, it should be replaced. If oil is evident outside of the shock absorber, it should also be replaced. Check the rubber bushes for wear or damage. If found defective, install new ones.

13-B-3. Installing the Rear Shock Absorber

Install the rear shock absorber in the reverse order of removing. When installing, apply vegetable grease on the interior of the rubber bushes.

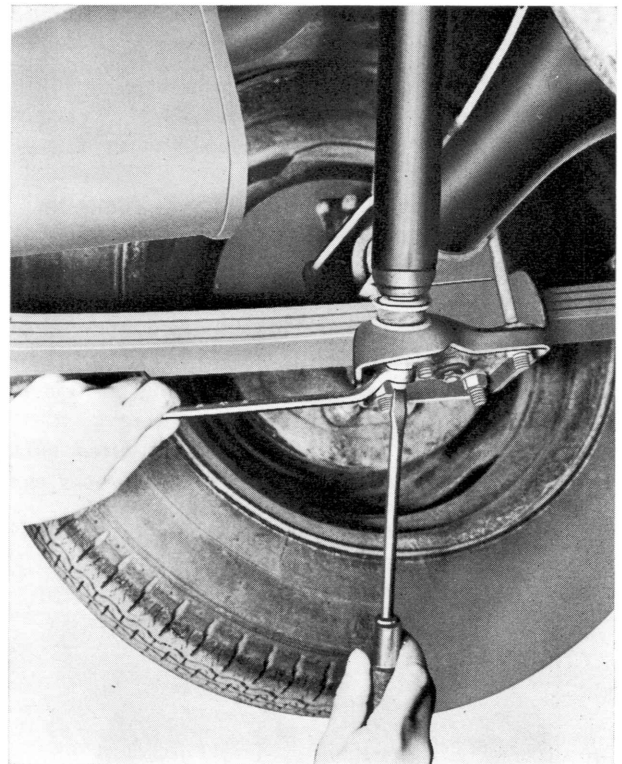

Fig. 13-23 Installing shock absorber

13-B-4. Removing the Rear Spring

1. Place the jack under the rear axle housing and raise the vehicle. Then, place a stand under the frame side rail.
2. Remove the wheel and then, lower the jack so that the load is relieved from the spring.

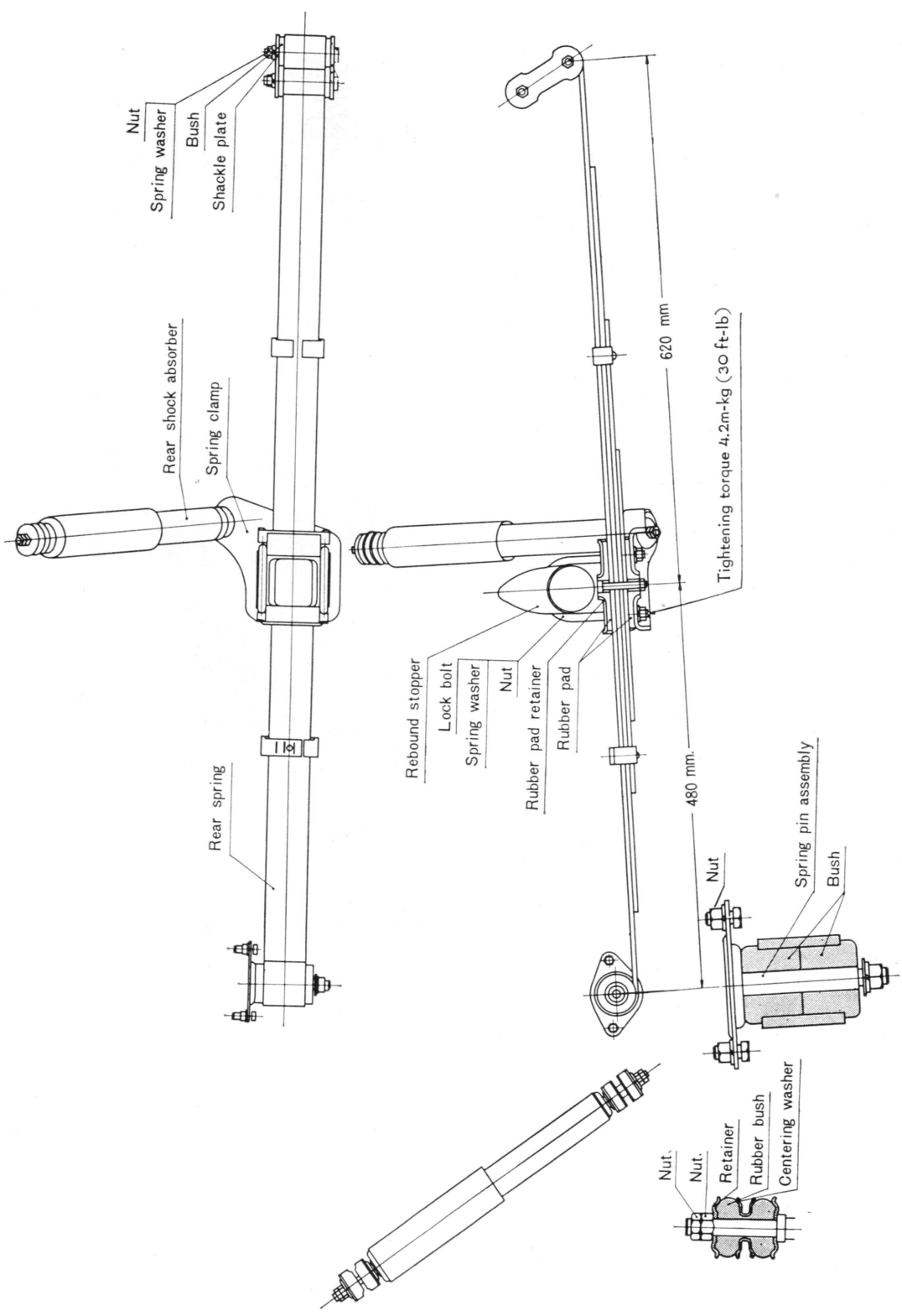

Fig. 13-24 Rear suspension

3. Disconnect the rear shock absorber at the lower mounting stud.
4. Remove the "U" bolt nuts and spring clamp.
5. Remove the spring pin nut, and remove two bolts and nuts attaching spring pin hanger to the frame bracket.
6. Remove the spring pin and remove the front end of the spring from the vehicle.
7. Remove the shackle pin nuts and shackle and remove the rear end of the spring from the vehicle.

13-B-5. Checking the Rear Spring

1. Check the rear springs for wear, fatigue, corrosion or damage. If found to be defective, repair or replace.
 2. Check the center bolt of the spring for looseness.
 3. Measure the diameter of the shackle pin and check the clearance between the shackle pin and the bush. Excessive clearance, due to wear, causes noise and affects steering stability. If it exceeds 0.5 mm. (0.020 in.), replace the bush or the shackle pin. If wear of the pin is more than 0.3 mm. (0.012 in.), install a new pin.
- The standard diameter is 13 mm. (0.511 in.).

13-B-6. Installing the Rear Spring

The springs are classified into three types, -, 0, +, according to the amount of camber and identified by marks on the main leaf surface. Spring with the same marking should be used on both sides.

The spring pins are fitted at the front first and then at the rear. In order to prevent the rubber bush from receiving torsion under standard load, fit the spring pin and the shackle plate temporarily, and fix the rear axle casing together with the spring, with

"U" bolts. Then tighten the spring pins to 4.0 m-kg (29 ft-lb).

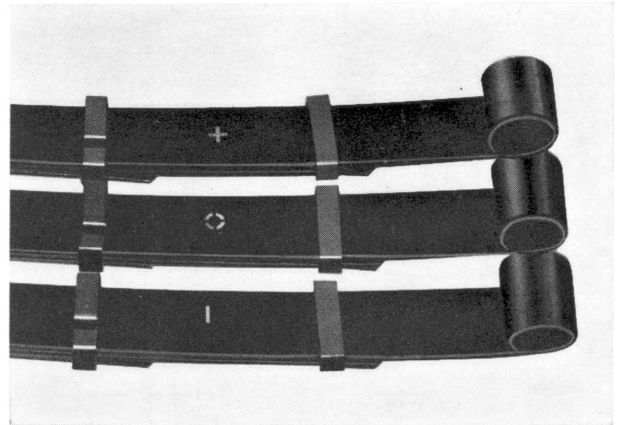

Fig. 13-25 Rear spring

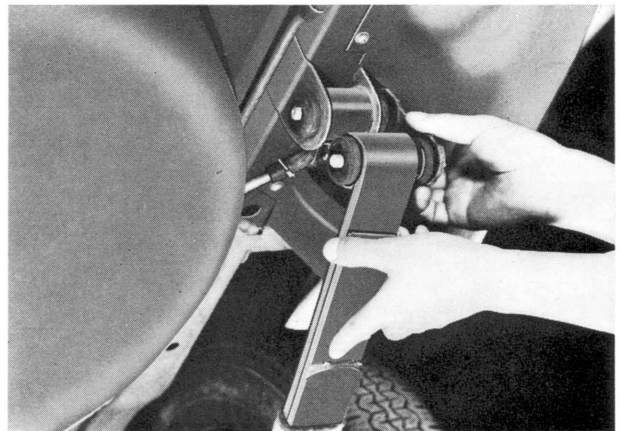

Fig. 13-26 Installing rear side of the rear spring

SPECIAL TOOLS

49 0223 640	Front suspension coil spring holder
49 0259 700	Cap nut wrench
49 0259 860	Ball joint remover and installer

BODY

14-A.	WINDSHIELD GLASS	14 : 3
14-A-1.	Removing the Windshield Glass.....	14 : 3
14-A-2.	Installing the Windshield Glass.....	14 : 3
14-A-3.	Intalling the Mould.....	14 : 4
14-B.	TOP CEILING	14 : 4
14-B-1.	Removing the Top Ceiling ...	14 : 4
14-B-2.	Installing the Top Ceiling.....	14 : 4
14-C.	DOOR	
14-C-1.	Disassembling the Door.....	14 : 5
14-C-2.	Assembling the Door.....	14 : 5

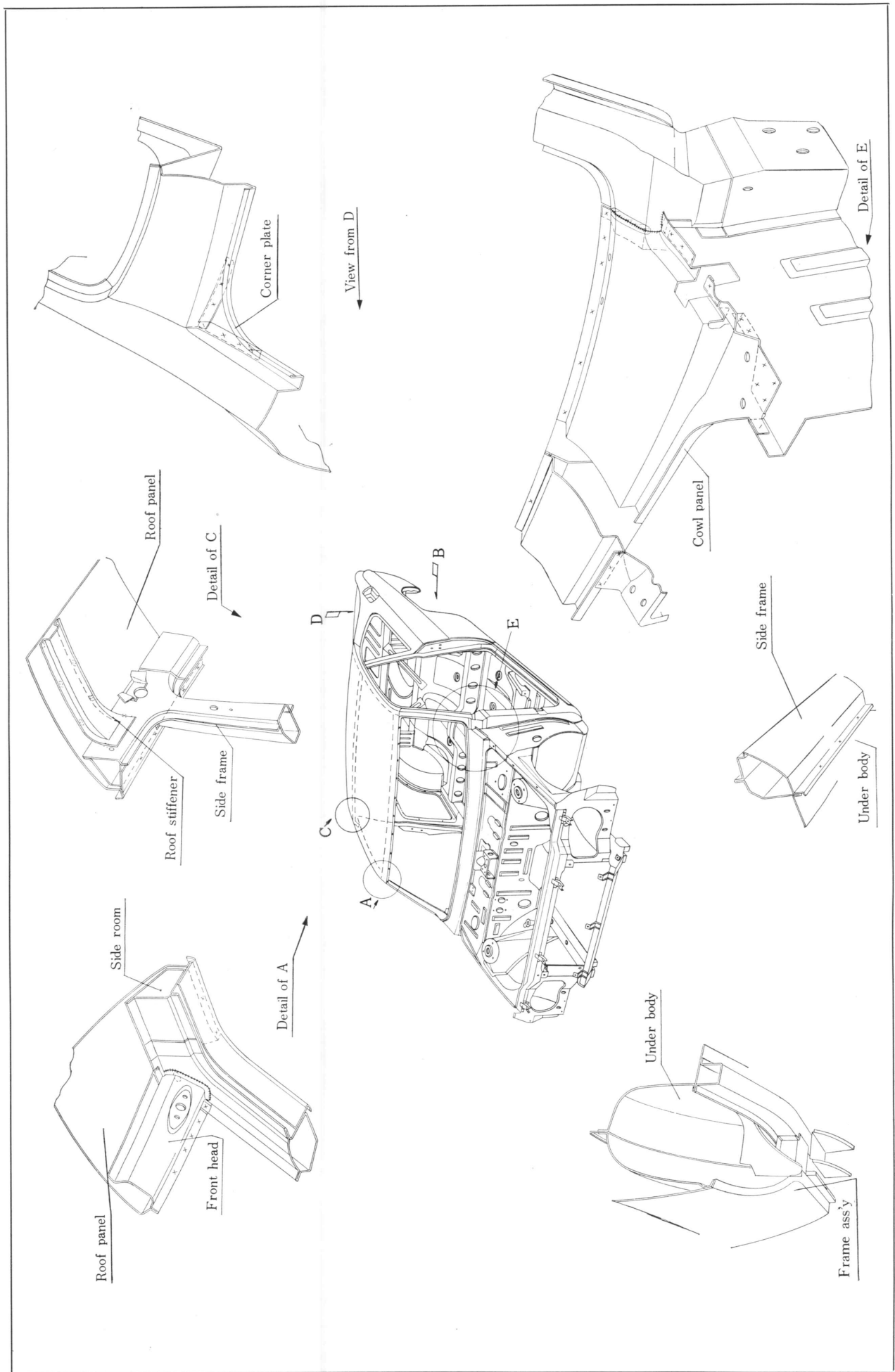

Fig. 14-1

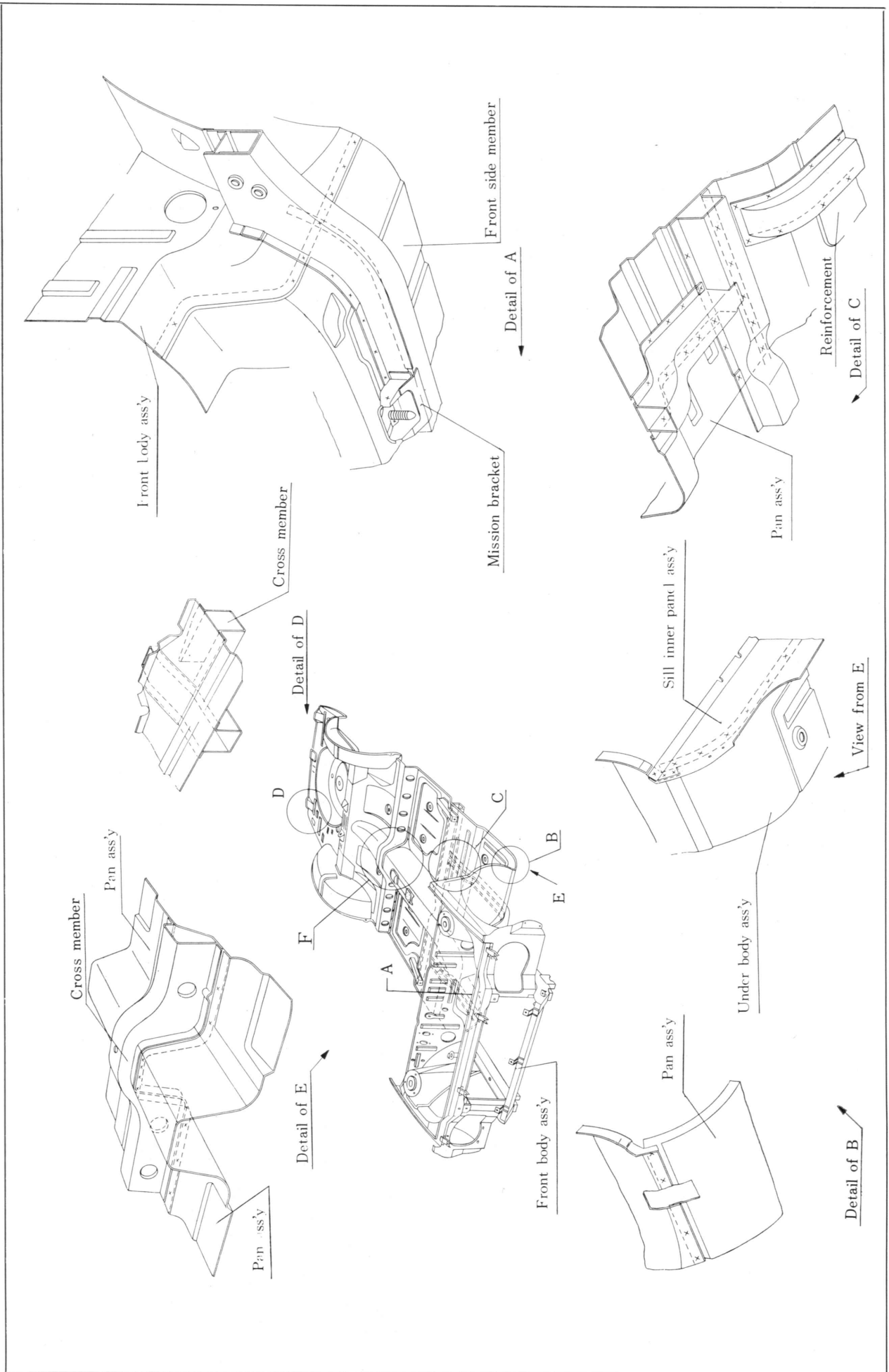

Fig. 14-2

14-A. WINDSHIELD GLASS

14-A-1. Removing the Windshield Glass

1. Remove the windshield wiper arms.
2. Remove the windshield mould from the weatherstrip.
3. Detach the adhesive cement between the weather strip and the body flange with a wooden spatula.



Fig. 14-3 Detaching adhesive cement

4. Drive out the inner lip of the weatherstrip along the edge of the windshield with a suitable tool from inside the vehicle while pushing the windshield glass outwards.

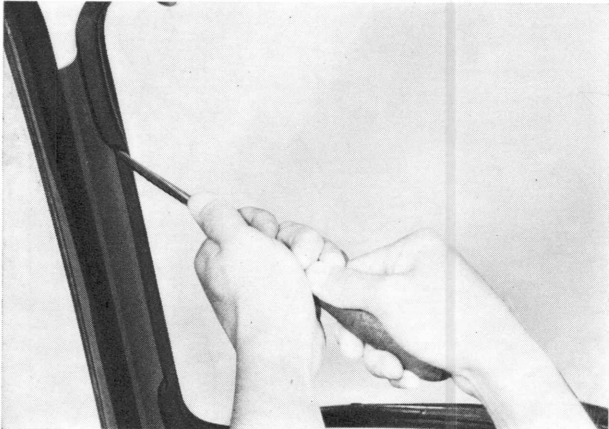

Fig. 14-4 Removing weatherstrip

5. Remove the windshield glass with the weatherstrip from the vehicle.
6. Remove the weather strip from the windshield glass.

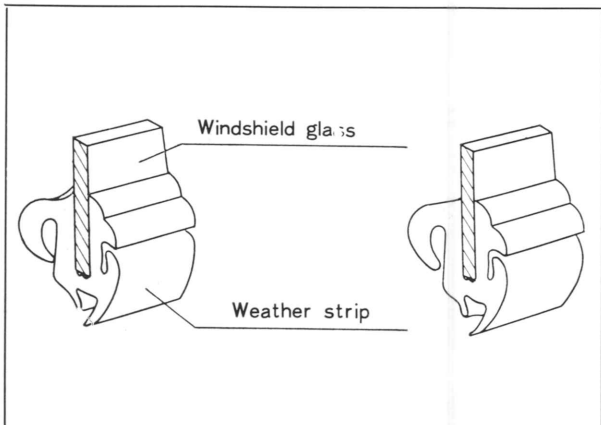

Fig. 14-5 Windshield glass and weatherstrip

14-A-2. Installing the Windshield Glass

Before installing the windshield glass, clean off the old adhesive cement thoroughly from the windshield glass and the body.

1. Install the weatherstrip along the edge of the windshield glass.

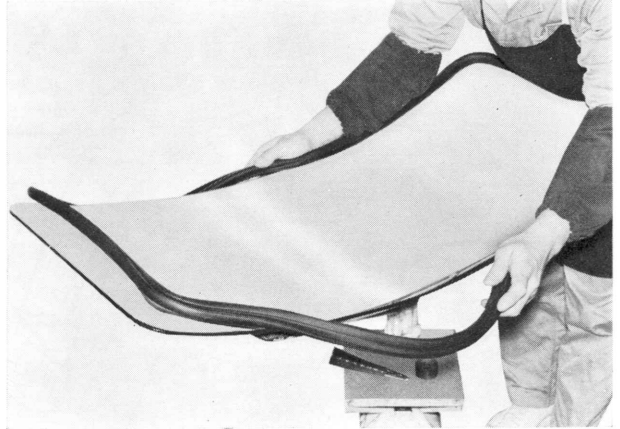

Fig. 14-6 Installing weatherstrip

2. Fit string of 4 mm. (0.16 in.) diameter into the groove of the weatherstrip, by using the **string fitting tool** (49 0118 801B).

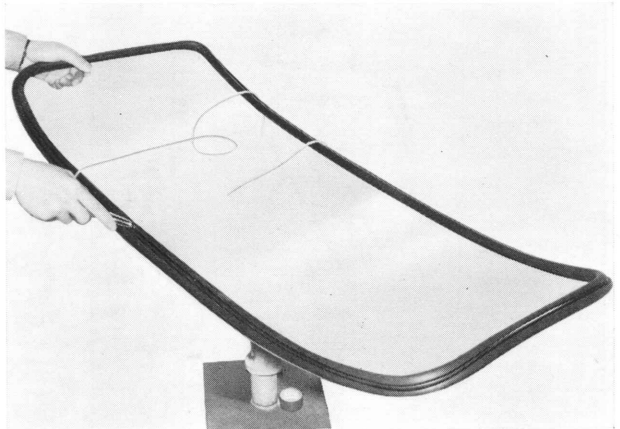

Fig. 14-7 Fitting string

3. Before fitting the windshield on the body, apply a liberal amount of liquid soap on the body flange, so as to make the body flange and the weatherstrip contact properly.



Fig. 14-8 Applying liquid soap

4. Place the windshield glass and the weatherstrip assembly into position on the body flange.
5. Pull the string so as to place the inner lip of the weather strip over the body flange. At the same time, tap the windshield with the hand from the outside as the inner lip is being settled on the body flange.

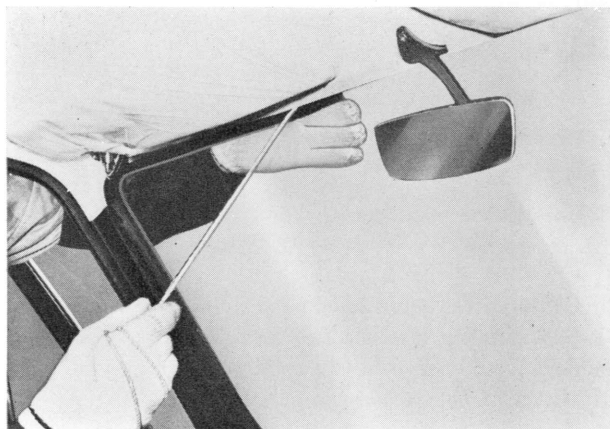

Fig. 14-9 Installing windshield glass

6. Make the weather strip and the body flange contact properly with the **insert pusher** (49 0118 750).



Fig. 14-10

7. Apply adhesive cement between the body flange and the weather strip, and also between the weather strip and the windshield glass.

14-A-3. Installing the Mould

1. After installation of windshield glass, apply a

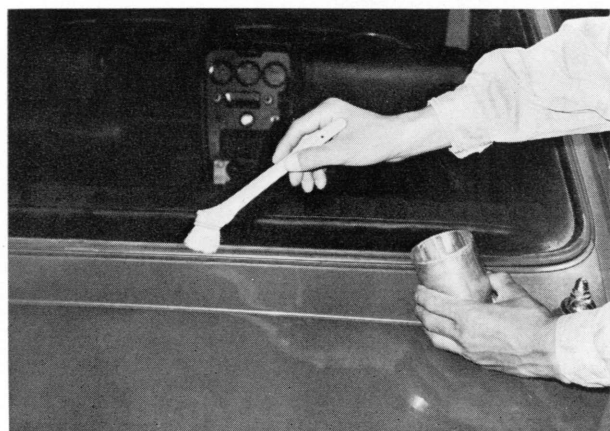

Fig. 14-11 Applying liquid soap

liberal amount of liquid soap to the mould fitting portion.

2. Fit string into the mould fitting groove of the weatherstrip, by using the **string fitting tool** (49 0118 801B).

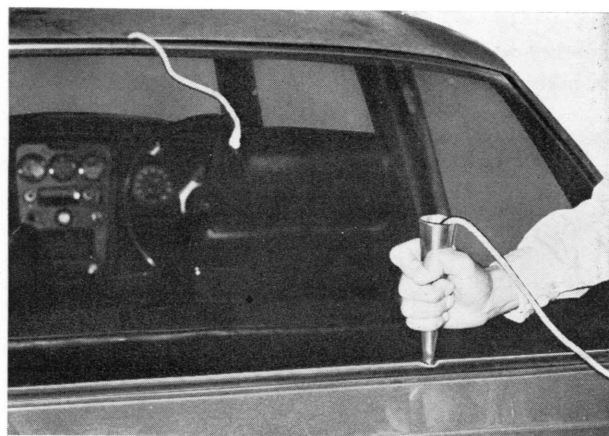

Fig. 14-12 Fitting string

3. Connect the upper, right, and left moulds with three joints. Push these against the groove of the weatherstrip and pull the string to fit the mould.

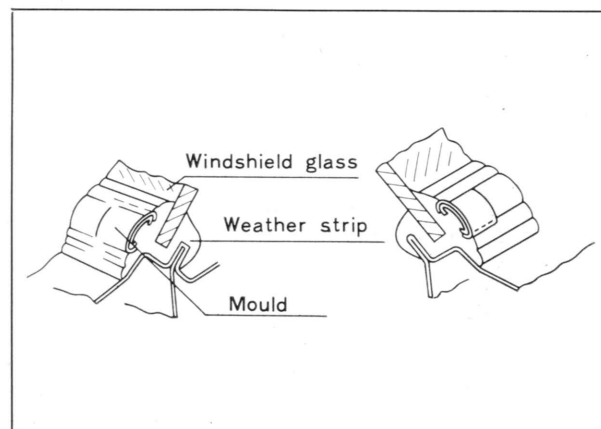

Fig. 14-13 Mould and weatherstrip

14-B. TOP CEILING

14-B-1. Removing the Top Ceiling

1. Remove the windshield glass and rear window glass. (Refer to Par. 14-A-1.)
2. Strip off the seaming welts and the weatherstrips from the body flange, being careful not to damage these.
3. Remove the rear view mirror, sun visor, interior lamp, etc.
4. Strip off the top ceiling (vinyl leatherette) from the end and remove the listing wires in successive order.

14-B-2. Installing the Top Ceiling

1. Affix the top insulations onto the body ceiling beforehand with adhesive cement and preheat the new top ceiling to a temperature of $30^{\circ} \sim 50^{\circ}\text{C}$ ($80^{\circ} \sim 120^{\circ}\text{F}$).
2. Insert both ends of each of the listing wires to their proper position in successive order beginning

wires do not swing down.

3. Apply neoprene adhesive cement to the outside of the body roof cowl flange.

4. After one or two minutes, pull the top ceiling from the front and back to avoid any slackening and glue both side onto the body flange, which is for fitting the window glass. When doing so, cut out notches on each corner of the top ceiling to prevent wrinkles.

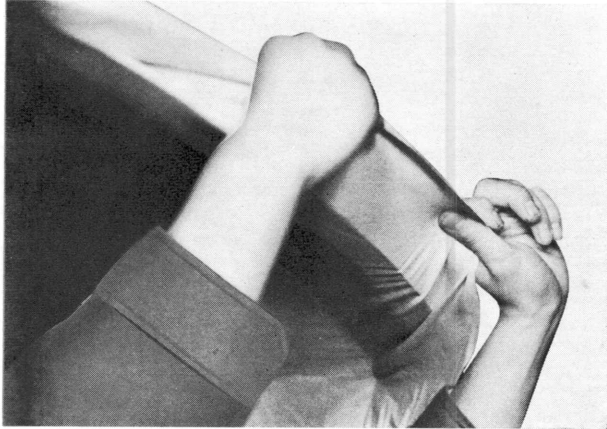

Fig. 14-14 Installing top ceiling

5. After the top ceiling is properly attached to the body flange, clip off all protruding edges.

6. Reinstall the rear view mirror, sun visor, etc.

14-C. DOOR

14-C-1. Disassembling the Door

1. Remove the arm rest and pull handle.
2. Remove the regulator handle and the door escutcheon.
3. Remove the door trim board.
4. Remove the inside screens (vinyl), which are installed to prevent water leakages.
5. Remove the inner and outer weatherstrips from the door body.

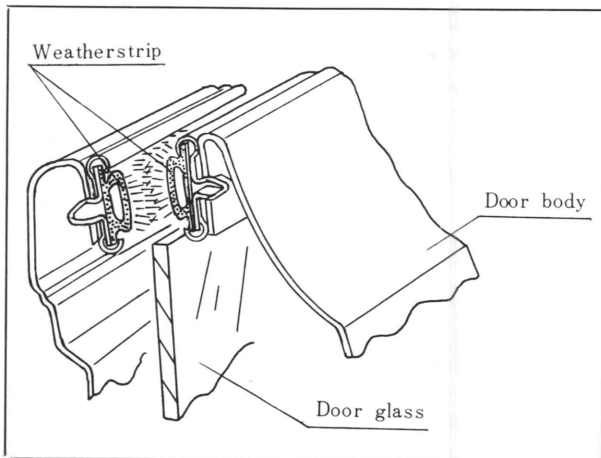

Fig. 14-15 Door and weatherstrip

6. Remove the door window glass. With the window glass lowered to half-opened position, it can be easily taken out.

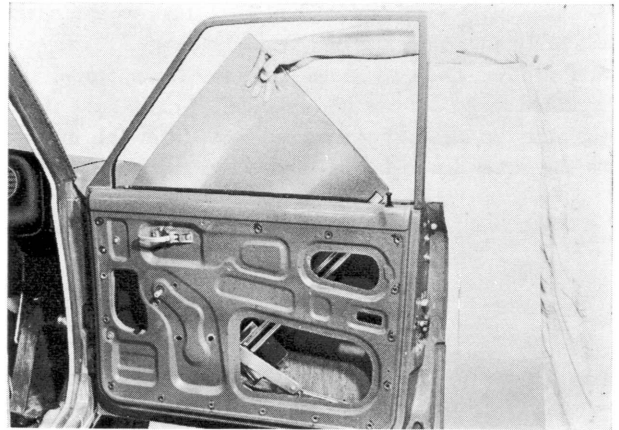

Fig. 14-16 Removing door glass

7. Remove the outer handle.

8. Pull out the fastener and remove the key cylinder.

9. Remove the door lock complete.

10. Remove the window regulator.

14-C-2. Assembling the Door

1. Install the outer handle with the pads.
2. Fix the key cylinder with the fastener.

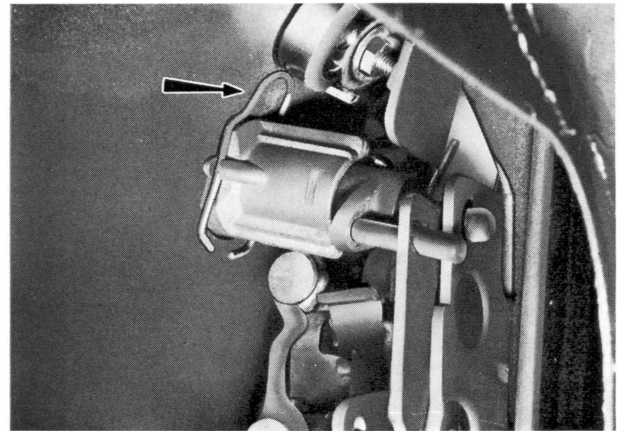

Fig. 14-17 Fixing key cylinder

3. Install the inner lever and remote control assembly.

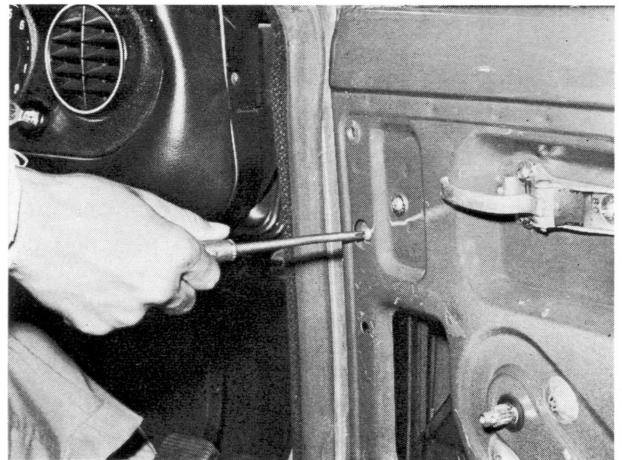

Fig. 14-18

4. Install the door lock complete and adjust the clearance between the push lever and the push button to be 1 mm. (0.04 in.) with the push lever base

attaching screws.

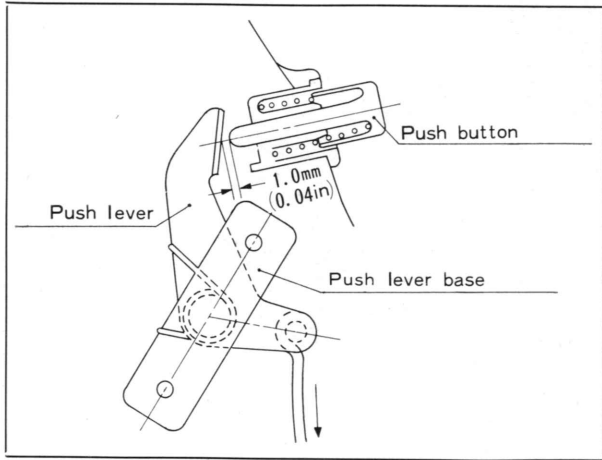

Fig. 14-19 Adjusting push button

5. Connect the remote control lever and the door lock link and tighten the screws.



Fig. 14-20

6. Install the door sash and tighten it with screws.
7. Install the door run channel into the door sash.
8. Install the weatherstrips to the door body.
9. Install and tighten the window regulator temporarily.
10. Install the door window glass, and securely tighten the window regulator while adjusting the alignment between the window glass and the door sash.

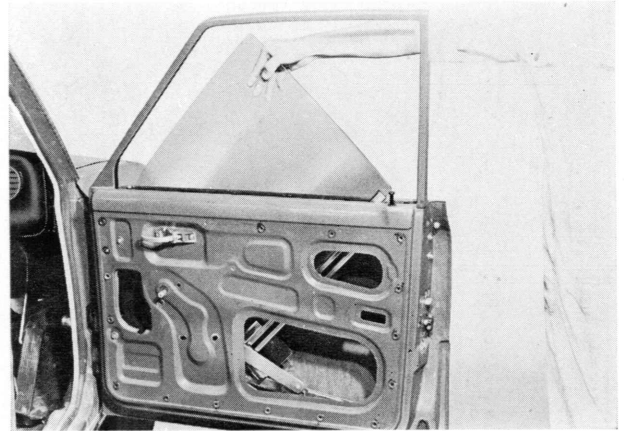

Fig. 14-21 Installing door glass

11. To prevent water leak, apply a solid sealing agent on the head of screws attaching the window regulator.
12. Install the door trim board and the rubber cushion.
13. Install the regulator handle with the door escutcheon.
14. Install the pull handle.

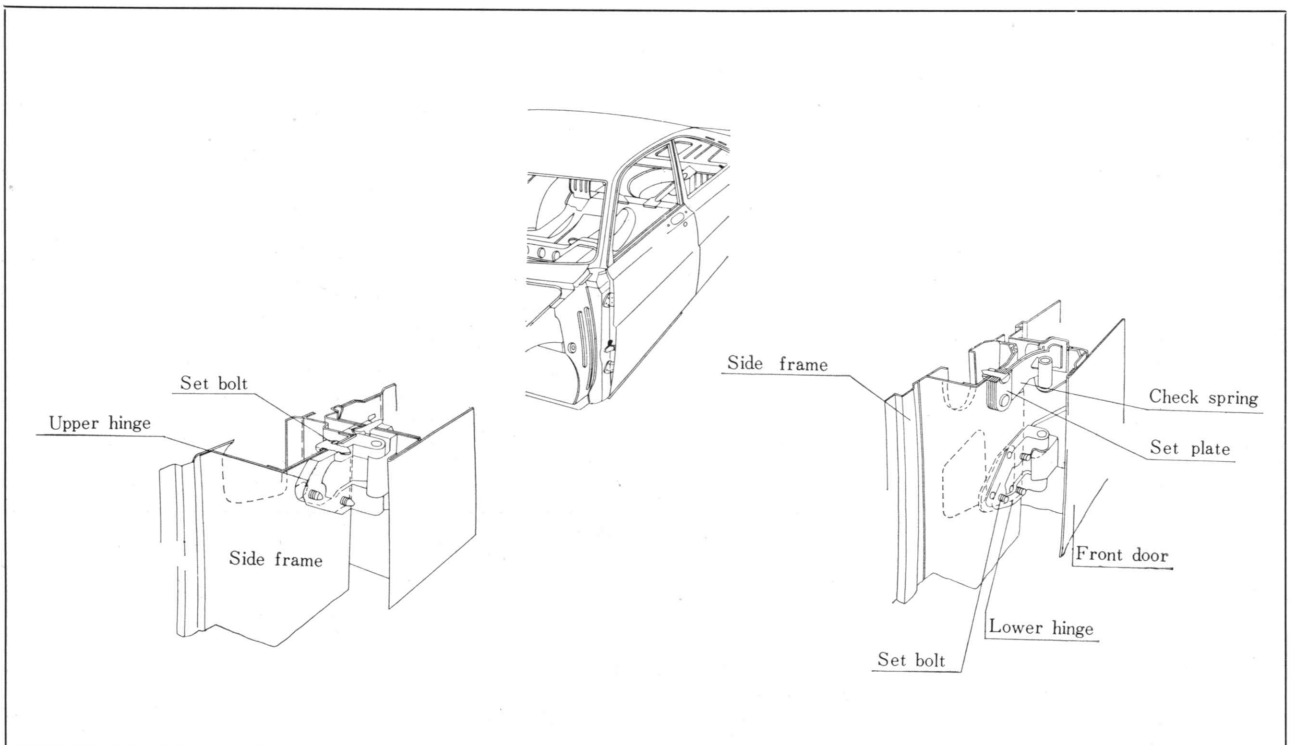

Fig. 14-21

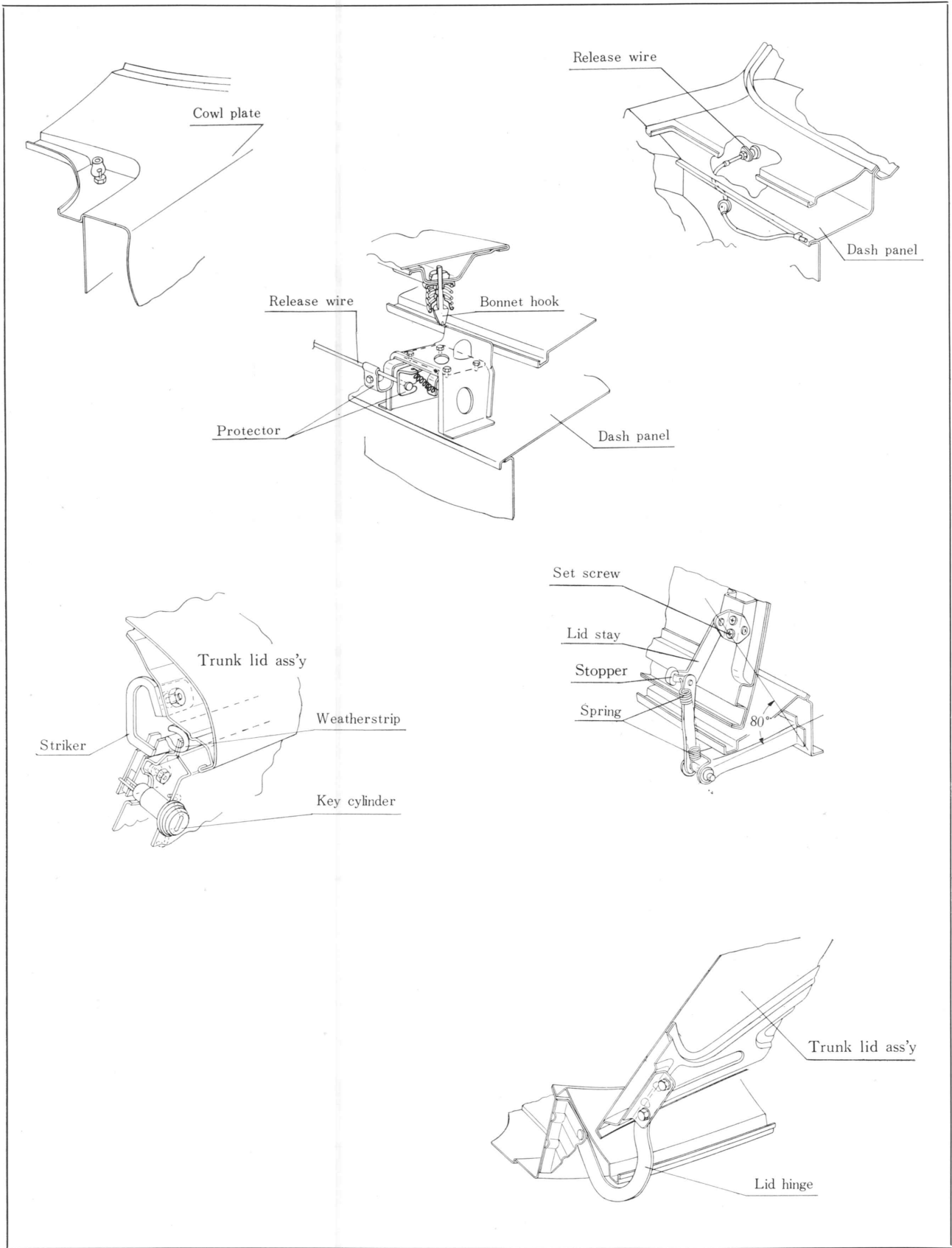

Fig. 14-22

SPECIAL TOOLS

49 0118 801B	String fitting tool
49 0118 750	Insert pusher

FRAME CHECKING DIMENSION

(for MAZDA R100 COUPÉ)

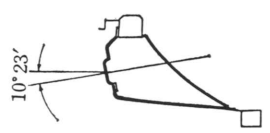
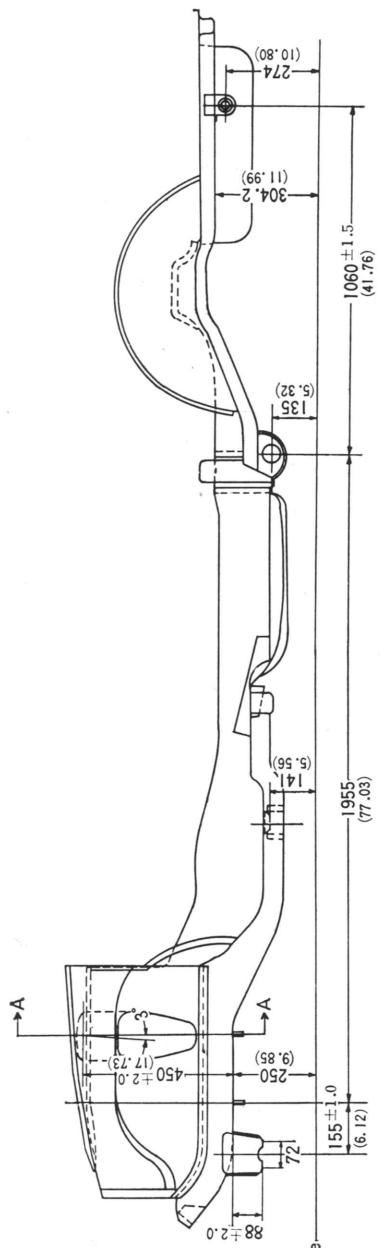
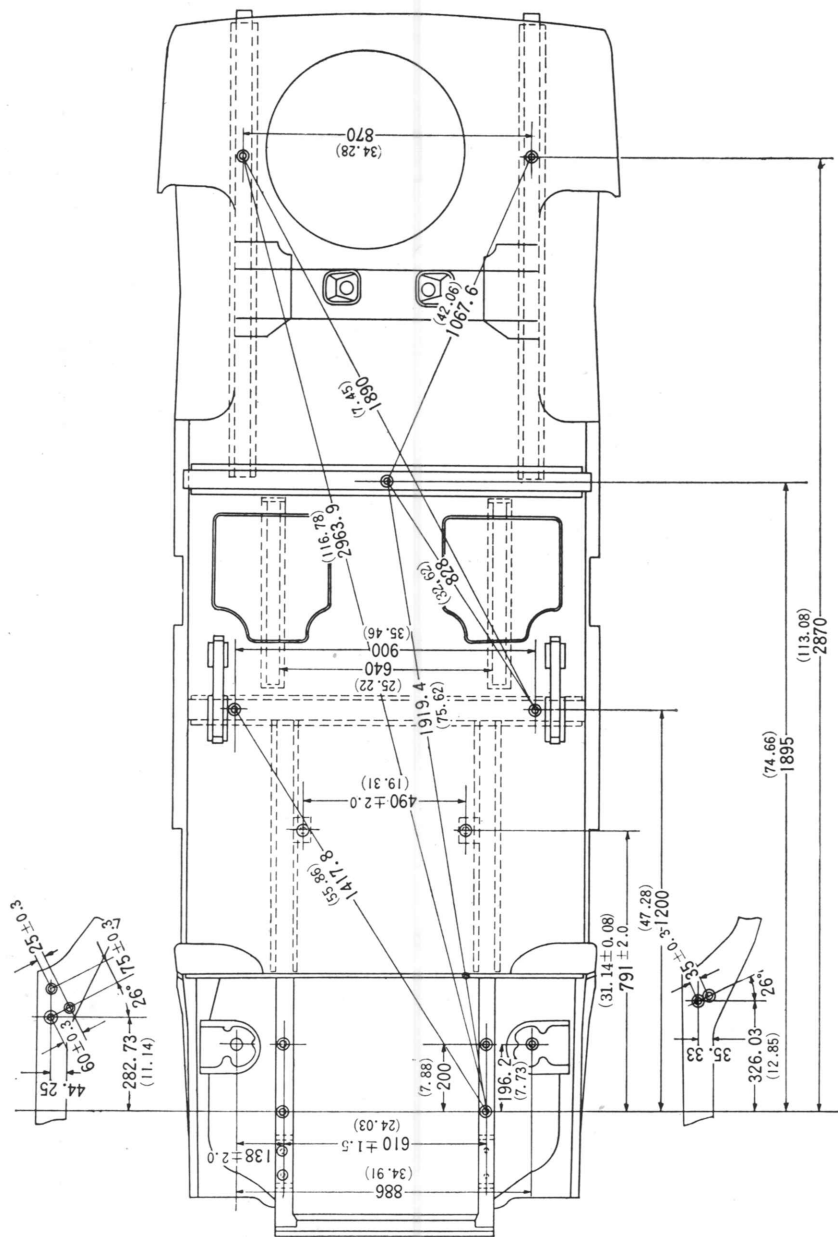

() Show's inch

Section A-A

Base line

BODY CHECKING DIMENSION
(for MAZDA R100 COUPÉ)

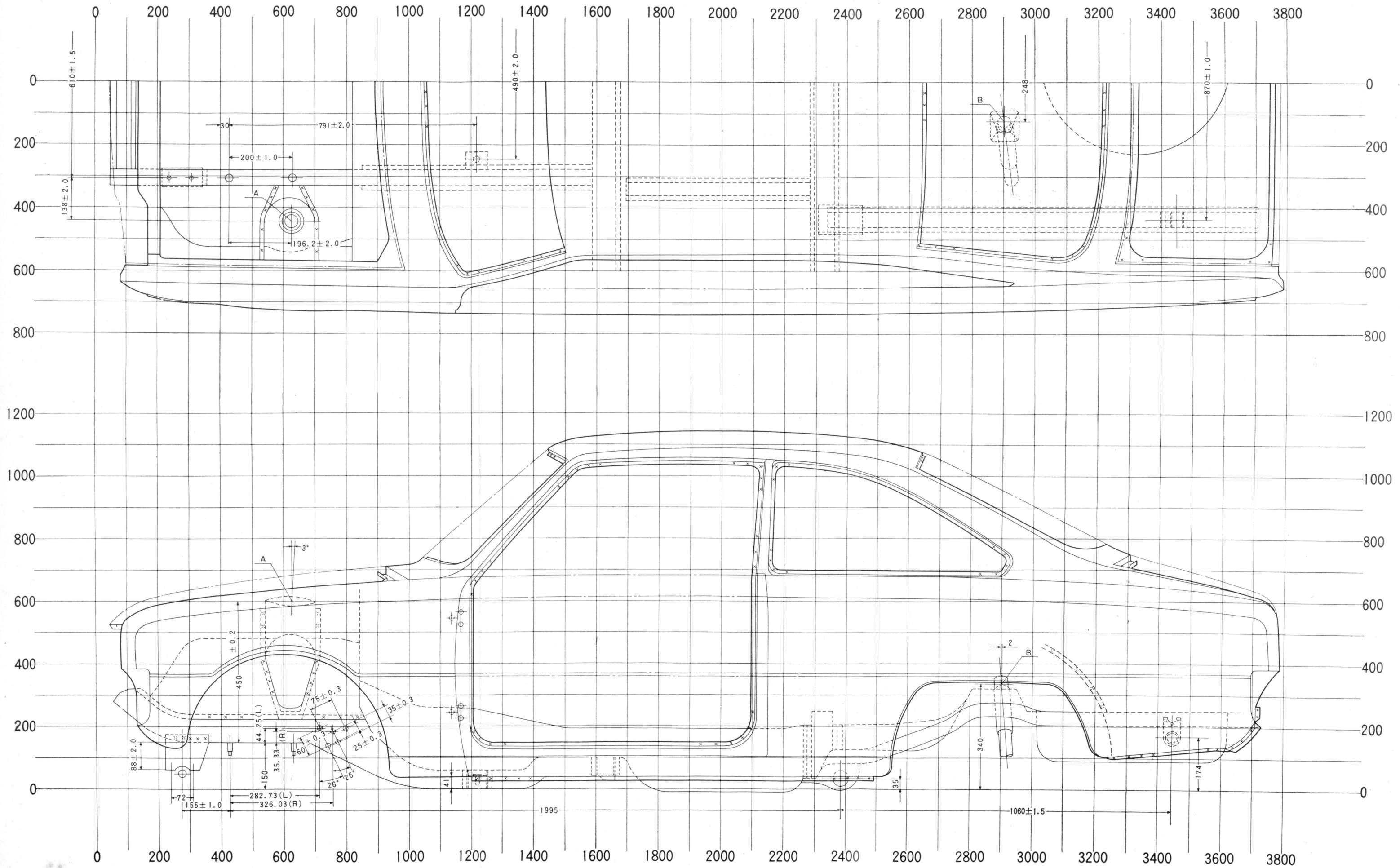

TECHNICAL DATA

ENGINE (General Data)			
Type	Rotary piston engine, in line 2 rotor, water cooled	Length	59.97 mm ⁺⁰ _{-0.02} (2.3611 in ⁺⁰ _{-0.0008})
Displacement	491 cc × 2 rotors (29.96 cu. in × 2 rotors)	Width	6 mm ^{-0.045} _{-0.063} (0.2362 in ^{-0.0018} _{-0.0025})
Compression ratio	9.4 : 1	Height	10 mm ⁺⁰ _{-0.1} (0.3937 in ⁺⁰ _{-0.0039})
Compression pressure	6.0 kg/cm ² at 280 rpm (85 lb/in ² at 280 rpm)	Limit of height	8.0 mm (0.315 in)
Max. brake horsepower	100 PS/7,000 rpm (JIS) 110 HP/7,000 rpm (SAE)	Clearance of apex seal and side housing :	Standard 0.01~0.05 mm (0.0004~0.0020 in)
Max. torque	13.5 m-kg/3,500 rpm (JIS) 100 ft-lb/4,000 rpm (SAE)	Limit	0.15 mm (0.0059 in)
Port timing :		Clearance of apex seal and rotor groove :	Standard 0.036~0.072 mm (0.0014~0.0028 in)
Intake opens	Primary : 32° A. T. D. C. Secondary : 32° A. T. D. C.	Limit	0.10 mm (0.004 in)
Intake closes	Primary : 40° A. B. D. C. Secondary : 40° A. B. D. C.	Apex seal spring :	Free height 5.0 mm (0.197 in)
Exhaust opens	75° B. B. D. C.	Set height	2.0 mm (0.079 in)
Exhaust closes	35° A. T. D. C.	Set load	2.9 kg ± 0.2 (6.4 lb ± 0.4)
		Spring constant	0.97 kg/mm (54.3 lb/in)
ENGINE		Corner seal :	
Front and rear housing :		Outside diameter	11 mm ^{-0.032} _{-0.043} (0.4331 in ^{-0.0013} _{-0.0017})
Limit of distortion	0.04 mm (0.002 in)	Width	7 mm ⁺⁰ _{-0.2} (0.2756 in ⁺⁰ _{-0.0079})
Limit of wear	0.10 mm (0.004 in)	Clearance of corner seal and rotor groove :	Standard 0.032~0.061 mm (0.0013~0.0024 in)
Rotor housing :		Limit	0.08 mm (0.003 in)
Width	60 mm ⁺⁰ _{-0.02} (2.3622 in ⁺⁰ _{-0.0008})	Corner seal spring :	Free height 2.6 mm (0.102 in)
Limit of distortion	0.04 mm (0.002 in)	Set height	1.0 mm (0.039 in)
Intermediate housing :		Set load	1.4 kg ± 0.3 (3.1 lb ± 0.7)
Limit of distortion	0.04 mm (0.002 in)	Spring constant	0.90 kg/mm (50.4 lb/in)
Limit of wear	0.10 mm (0.004 in)	Side seal :	Thickness 1.0 mm ^{-0.014} _{-0.039} (0.0394 in ^{-0.0006} _{-0.0015})
Width	50 mm ± 0.1 (1.9685 in ± 0.0039)	Width	3.5 mm ⁺⁰ _{-0.1} (0.1378 in ⁺⁰ _{-0.0039})
Rotor :		Clearance of side seal and rotor groove :	Standard 0.04~0.07 mm (0.0016~0.0028 in)
Standard Weight (with inter- nal gear)	3.65 kg (8.03 lb)	Limit	0.10 mm (0.004 in)
Inside diameter	80 mm ^{+0.019} ₋₀ (3.1497 in ^{+0.0008} ₋₀)	Clearance of side seal and corner seal :	Standard 0.13~0.25 mm (0.0051~0.0098 in)
Protrusion of land	0.10~0.15 mm (0.004~0.006 in)	Limit	0.40 mm (0.016 in)
Permissible protrusion of land	Max. 0.15 mm (0.006 in) Min. 0.085mm (0.004 in)	Side seal spring :	Free height 2.2 mm (0.087 in)
Width of apex seal groove	6 mm ± 0.009 (0.2362 in ± 0.0004)	Set height	1.0 mm (0.039 in)
Diameter of corner seal cave	11 mm ^{+0.018} ₋₀ (0.4331 in ^{+0.0007} ₋₀)	Set load	3.2 kg ± 0.3 (7.1 lb ± 0.7)
Depth of corner seal cave	7.9 mm ⁺⁰ _{-0.2} (0.3110 in ⁺⁰ _{-0.0079})	Spring constant	2.7 kg/mm (151.1 lb/in)
Width of side seal groove	1.0 mm ^{+0.039} _{+0.014} (0.0394 in ^{+0.0015} _{+0.0006})	Oil seal :	Thickness 5.5 mm ^{+0.2} ₋₀
Depth of side seal groove	4.4 mm ⁺⁰ _{-0.2} (0.1732 in ⁺⁰ _{-0.0079})		
Width of oil seal groove	3.5 mm ^{+0.06} _{+0.03} (0.1378 in ^{+0.0024} _{+0.0012})		
Depth of oil seal groove	6.4 mm ± 0.1 (0.2520 in ± 0.0039)		
Apex seal :			

Width	3.35 mm $\begin{matrix} +0.05 \\ -0.10 \end{matrix}$ (0.1319 in $\begin{matrix} +0.0020 \\ -0.0039 \end{matrix}$)	LUBRICATING SYSTEM	Oil pump :	
Outside diameter : Outer oil seal	126 mm $\begin{matrix} -0.04 \\ -0.10 \end{matrix}$ (4.9607 in $\begin{matrix} -0.0016 \\ -0.0039 \end{matrix}$)		Feeding capacity	16~20 liter/min (34~42 U.S. pint/min, 28~35 Imp. pint/min) at 6,000 rpm
Inner oil seal	116 mm $\begin{matrix} -0.03 \\ -0.09 \end{matrix}$ (4.5670 in $\begin{matrix} -0.0012 \\ -0.0035 \end{matrix}$)		Outer rotor and body clearance	0.20~0.25 mm (0.008~0.010 in)
Contact width of oil seal lip	Less than 0.8 mm (Less than 0.0315 in)		Outer rotor and inner rotor clearance	0.01~0.09 mm (0.0004~0.0035 in)
Oil seal spring : Free height	Inner side : 2.6 mm (0.102 in) Outer side : 2.5 mm (0.098 in)		Rotor end float	0.1~0.2 mm (0.004~0.008 in)
Set height	1.0 mm (0.039 in)		Oil pump drive gear :	
Set load	12 kg $\begin{matrix} +3 \\ -0 \end{matrix}$ (26.5 lb $\begin{matrix} +6.6 \\ -0 \end{matrix}$)		No. of teeth	31
Spring constant	Inner side : 7.5 kg/mm (419.6 lb/in) Outer side : 8.3 kg/mm (464.4 lb/in)		Backlash	0.08~0.12 mm (0.003~0.005 in)
Main bearing : Inner diameter	43 mm $\begin{matrix} +0.055 \\ +0.040 \end{matrix}$ (1.6929 in $\begin{matrix} +0.0022 \\ +0.0016 \end{matrix}$)		Oil pressure :	
Main bearing clearance : Standard	0.04~0.06 mm (0.0016~0.0024 in)		Normal	3~5 kg/cm ² at 3,000 rpm (43~71 lb/in ² at 3,000 rpm)
Limit	0.10 mm (0.0039 in)		Warning lamp lights	0.3 kg/cm ² (4.3 lb/in ²)
Rotor bearing : Inner diameter	74 mm $\begin{matrix} +0.050 \\ +0.025 \end{matrix}$ (2.9134 in $\begin{matrix} +0.0020 \\ +0.0010 \end{matrix}$)		Relief spring :	
Rotor bearing clearance : Standard	0.04~0.08 mm (0.0016~0.0031 in)		Free length	46.4 mm (1.8268 in)
Limit	0.10 mm (0.0039 in)		Set length	35.3 mm (1.3898 in)
Eccentric shaft : Eccentricity of rotor journal	15 mm $\begin{matrix} +0 \\ -0.03 \end{matrix}$ (0.5906 in $\begin{matrix} +0 \\ -0.0012 \end{matrix}$)		Set load	5.0 kg (11 lb)
Main journal diameter	43 mm $\begin{matrix} +0 \\ -0.016 \end{matrix}$ (1.6929 in $\begin{matrix} +0 \\ -0.0006 \end{matrix}$)		Oil thermo-valve :	
Rotor journal diameter	74 mm $\begin{matrix} -0.015 \\ -0.030 \end{matrix}$ (2.9134 in $\begin{matrix} -0.0006 \\ -0.0012 \end{matrix}$)		Starts to open	71°C (160°F)
Permissible run-out	Less than 0.03 mm (Less than 0.0012 in)		Lift	8.5 mm $\begin{matrix} +2.5 \\ -0 \end{matrix}$ at 86°C (0.335 in $\begin{matrix} +0.098 \\ -0 \end{matrix}$ at 187°F)
End play	0.04~0.07 mm (0.0016~0.0028 in)		Return spring :	
Internal gear : No. of teeth	51		Wire diameter	1.8 mm (0.0709 in)
Backlash of internal gear and stationary gear	0.06~0.08 mm (0.0024~0.0031 in)	Free length	43.8 mm ± 0.5 (1.724 in ± 0.020)	
Stationary gear : No. of teeth	34	Initial load	4 kg (8.8 lb)	
Inner diameter	48 mm $\begin{matrix} +0.016 \\ -0 \end{matrix}$ (1.8898 in $\begin{matrix} +0.0006 \\ -0 \end{matrix}$)	Spring constant	0.432 kg/mm (24.2 lb/in)	
		Oil cooler :		
		Core area	2.05 m ² (22 ft ²)	
		Capacity	0.54 liter (1.1 US. pint, 1.0 Imp. pint)	
		Oil metering pump :		
		Feeding capacity	6.5 \pm 1 cc/10 min at 2,000 rpm	
		COOLING SYSTEM		
		Water pump :		
		Type	Centrifugal	
		Feeding capacity	110~120 liter/min (233~254 U.S. pint, 194~211 Imp. pint)	
		Fan :		
		Fan diameter	350 mm (13.78 in)	
		Number of blades	4	
		Water pump pulley ratio	1.035 : 1	
		Thermostat :		
		Starts to open	76.5°C (170°F)	
		Fully opens	90°C (194°F)	
		Lift	More than 8 mm at 90°C (More than 0.32 in at 194°F)	
		Radiator :		
		Type	Corrugated fin	
		Core area	4.77 m ² (51 ft ²)	
		Relief valve pressure	0.9 kg/cm ² (12.8 lb/in ²)	
		Cooling capacity :		
		With heater	7.0 liter (15 US. pint, 12 Imp. pint)	
		Without heater	6.3 liter (13 US. pint, 11 Imp. pint)	

FUEL SYSTEM			
Fuel tank capacity	60 liter (16 US. gallon, 13 Imp. gallon)	Lock test	Current: Less than 70 amp at 3,600 rpm or more Voltage: 6.0 volt Current: 60 amp or less Torque: 2.7 m-kg (19.5 ft-lb)
Fuel filter	Paper element, cartridge type	Brushes	4
Fuel pump :		Brush spring tension	1.13 kg (2.5 lb)
Type	Electrical	Magnet switch operating voltage	9.0 volt
Rated terminal voltage	12 V	Alternator :	
Min. operating voltage	Less than 10 V	Ground polarity	Negative
Fuel pressure	0.20~0.25 kg/cm ² (2.8~3.6 lb/in ²)	Rated output	12 volt 33 amp
Fuel feeding capacity	More than 1,300 cc/min (2.7 US. pint/min, 2.3 Imp.pint/min)	Number of poles	8
Current on full discharging	Less than 1.5 A	No load test	Voltage: 14 volt at 1,050 rpm or less Current: 0 amp
Point gap	1 mm (0.039 in)	Load test	Voltage: 14 volt at 2,500 rpm or less Current: 26.5 amp
Carburettor :		Brush spring pressure	350 gr± (0.8 lb)
Type	Down-draft, Zenith Stromberg	Slip ring diameter	33 mm±0.2 (1.299 in±0.008)
Venturi	Primary : 19×8 mm (0.748×0.315 in) Secondary : 25×10 mm (0.984×0.393 in)	Ratio of alternator and eccentric shaft	2 : 1
Main jet	Primary : #80 Secondary : #130	Regulator :	
Main air bleed	Primary : #80 Secondary : #140	Constant voltage relay	Air gap : 0.7~1.1 mm (0.028~0.043 in) Point gap : 0.3~0.4 mm (0.012~0.016 in) Back gap : 0.75~1.1 mm (0.030~0.043 in) 14 volt±0.5
Slow jet	Primary : #45 Secondary : #60	Regulated voltage, without load	
Slow air bleed	Primary : #220 Secondary : #150	Wiper motor :	
Vacuum jet	Primary : #120 Secondary : #110	No load characteristics :	Current: Less than 2.5 amp (Both high & low speed) Wiping frequency : Low 47 ~60 High 62~85 Starting voltage: 10 V Wiping angle : Driver side 88°±3 Passenger side 100°±3 Load : 4 kg-cm (3.4 in-lb) Current: Less than 3.5 A (Wind shield wet surface) Wiping frequency : Low 45~60 High 60~85 Wiping angle : Driver side 93° ⁺⁰ ₋₆ Passenger side 105° ⁺⁰ ₋₆
Pump nozzle	0.6 mm (0.024 in)	Load characteristics :	
ELECTRICAL SYSTEM		Bulbs :	
Battery :		Headlamp	50/40 W
Voltage	12 volt	Side and front turn signal lamp	23/7 W
Capacity	45 AH (20 H.R)	Rear combination lamp	23/7 W
Terminal ground	Negative	License lamp	8 W
Specific gravity	Fully charged : 1.26 Recharge at : 1.20	Interior lamp	5 W
Distributor :		Instrument panel	3 W
Contact point gap	0.45 mm (0.018 in)	CLUTCH	
Point pressure	500~650gr (1.1~1.4 lb)	Type	Single dry plate, diaphragm spring
Condenser capacity	0.15μF±10%	Facing :	
Centrifugal advance :		Inner diameter	130 mm (5.118 in.)
Leading	Starts : 0° at 500 rpm Maximum : 5° at 1,500 rpm	Outer diameter	200 mm (7.874 in.)
Vacuum advance :		Thickness (single plate)	3.5 mm±0.1 (0.138 in.±0.004)
Leading	Starts : 0° at 100 mm Hg Maximum : 11° at 400 mm Hg		
Trailing	Starts : 0° at 100 mm Hg Maximum : 15° at 350 mm Hg		
Dwell angle	58°±3°		
Firing order	1-2		
Ignition timing	Trailing : 5° A. T. D. C. Leading : 0°		
Mark location	Eccentric shaft pulley		
Spark plug :			
Type and gap	NGK B-8EE-0.7 mm (0.028 in) Denso W25EG-0.6 mm (0.024 in)		
Thread	14 mm		
Starting motor :			
Capacity	1.0 KW		
Free running test	Voltage : 11 volt		

Permissible distortion of disk	0.04 mm (0.0016 in.)	Wheel cylinder bore	15.87 mm (0.6249 in.)
Clearance between push rod and clutch release fork	3.0 mm (0.12 in.)	Brake drum inner diameter	200 mm (7.874 in.)
Pedal free travel	30~35mm (1.2~1.4 in.)	Brake disk :	
Master cylinder bore	15.87 mm (0.6249 in.)	Thickness	10 mm (0.3937 in.)
Release cylinder bore	17.46 mm (0.6874 in.)	Permissible run-out	0.15 mm (0.0059 in.)
		Outer diameter	244 mm (9.6064 in.)
TRANSMISSION		STEERING	
Type	Four forward-speed and one reverse-speed, with synchro mesh for all forward and sliding mesh for reverse	Type	Recirculating ball nut
Shift lever location	Floor	Reduction ratio	17~19 : 1
Gear ratio :		Free motion of steering wheel	10~20 mm (0.4~0.8 in.)
First	3.737	Maximum steering angle :	
Second	2.202	Inner wheel	42°20'
Third	1.435	Outer wheel	31°50'
Top	1.000	Lubricant	EP. SAE 90
Reverse	4.024	Oil capacity	250 cc (0.53 US. pint, 0.44 Imp. pint)
Lubricant	Above -18°C (0°F) : EP. SAE 90	Backlash between rack and sector gear	0
	Below -18°C (0°F) : EP. SAE 80	Worm bearing preload	1.0~4.0 cm-kg (0.9~3.5 in-lb)
Oil capacity	1.3 liter (2.7 US. pint, 2.3 Imp. pint)	End clearance of sector shaft	0.02~0.08 mm (0.0008~0.0031 in.)
PROPELLER SHAFT		Standard play of ball stud (in axial direction)	0~0.20 mm (0~0.0079 in.)
Length	1033 mm (40.66 in.)	Steering geometry :	
Permissible unbalance	15 cm-gr at 4,000 rpm (0.20 in-oz at 4,000 rpm)	King pin inclination	8°01'
Permissible run-out	0.4 mm (0.016 in.)	Camber	0°59'
Spider diameter	14.72 mm (0.5795 in.)	Caster	2°
		Toe-in	1~3 mm (0.04~0.12 in.)
		Trail	2 mm (0.08 in.)
REAR AXLE		FRONT SUSPENSION	
Type	Semi-floating, hypoid gears	Type	Coil spring, hydraulic shock absorber
Reduction ratio	3.70	Spring constant	1.85 kg/mm±0.13 (103 lb/in)
Number of teeth	37 : 10	Spring pressure :	When the spring length is compressed to 197 mm (7.756 in)
Lubricant	Above -18°C (0°F) : HP. SAE 90	1 dot	246~252 kg (541~554 lb)
	Below -18°C (0°F) : HP. SAE 80	2 dot	252~258 kg (554~568 lb)
Oil capacity	1.2 liter (2.5 US. pint, 2.1 Imp. pint)	3 dot	258~264 kg (568~581 lb)
Mounting distance	92 mm±0.025 (3.6221 in ±0.0010)	Wire diametr	11.5 mm (0.452 in)
Pinion bearing preload	9~14 cm-kg (7.8~12.2 in-lb)	Coil diameter	110 mm (4.33 in)
Backlash between ring gear and drive pinion	0.17~0.19 mm (0.0067~0.0075 in)	Free length	343 mm (13.50 in)
Backlash between side gear and pinion	Less than 0.10 mm (Less than 0.0039 in)	Fitting length	205 mm (8.171 in)
BRAKE		Piston rod :	
Master cylinder bore	17.46 mm (0.6874 in.)	Diameter	20.0 mm (0.788 in)
Permissible clearance piston & bore	0.15 mm (0.0059 in.)	Permissible run-out	0.15 mm (0.006 in)
Pedal free travel	5~10 mm (0.2~0.4 in)	Piston assembly :	
Brake lining :		Relief valve thickness	0.15 mm (0.006 in)
Lining dimension (Width×Thickness×Length)		Check valve thickness	0.40 mm (0.016 in)
Front	46.9×9.7×61 mm (1.846×0.381×2.401 in)	Flatness	Less than 0.02 mm (0.008 in.)
Rear	32×4×200 mm (1.259×0.157×7.874 in)	Pressure tube :	
Number of lining per wheel	2	Permissible run-out	0.2 mm (0.008 in)
		Inner diameter	Less than 30.07 mm (1.184 in.)
		Bottom valve :	
		Check valve thickness	0.40 mm (0.016 in)
		Orifice valve thickness	0.15 mm (0.006 in)
		Relief valve thickness	0.15 mm (0.006 in)
		Seatthickness	0.10 mm (0.004 in)

T

REAR SUSPENSION		WEIGHTS AND DIMENSIONS			
Type	Semi-elliptic spring, hydraulic shock absorber	Overall length	3,830 mm (150.79 in)		
Spring constant	2.23 kg/mm ± 0.20 (124.8 lb/in. ± 11.2)	Overall width	1,480 mm (58.27 in)		
Number of leaves	5	Overall height	1,345 mm (52.95 in)		
Length	1100mm (43.31 in)	Wheel base	2,260 mm (88.98 in)		
Width	50 mm (1.969 in)	Tread :			
Thickness :		Front	1,200 mm (47.24 in)		
No. 1 & No. 2	6 mm (0.236 in)	Rear	1,190 mm (46.85 in)		
No. 3, No. 4 & No. 5	5 mm (0.197 in)	Overhang :			
WHEELS & TIRES		Front	595 mm (23.43 in)		
		Rear	930 mm (36.62 in)		
		Road clearance	160 mm (6.30 in)		
		Curb weight (no load)	825 kg (1,819 lb)		
		Curb weight distribution :			
		Front	455 kg (1,003 lb)		
		Rear	370 kg (816 lb)		
		Seating capacity	4		
		Minimum turning radius	4.1 m (161.42 in)		
				TIGHTENING TORQUE	
		Wheel type :		Tension bolts	2.5 m-kg (18 ft-lb)
		Front	4-JX 14 WDC	Flywheel lock nut	45 m-kg (350 ft-lb)
		Rear	4-JX 14 WDC	Eccentric shaft pulley bolt	7.0 m-kg (50 ft-lb)
		Tire :		Spark plug	2.0 m-kg (14 ft-lb)
		Front	145 SR 14 (Radial tire)	Oil pan tightening nuts	0.6 m-kg (4.5 ft-lb)
Rear	145 SR 14 (Radial tire)	6 mm bolt & nut	1.0 m-kg (7 ft-lb)		
Tube :		8 mm bolt & nut	2.0 m-kg (15 ft-lb)		
Front	145 SR 14	10 mm bolt & nut	4.0 m-kg (30 ft-lb)		
Rear	145 SR 14				
Air pressure :					
Front	1.8 kg/cm ² (26 lb/in ²)				
Rear	1.8 kg/cm ² (26 lb/in ²)				
Permissible unbalance	360 cm-gr (5 in-oz), Less than 30 gr (1.0 oz) at rim				
Permissible deviation of disk wheel	Under 1.3 mm (0.05 in)				